

VAPRO®
VAPOR PRESSURE OSMOMETER

MODEL 5520

USER'S MANUAL

Copy

M2468-4 rev B

© 1995-2004 Wescor, Inc.
All rights reserved. Printed in the United
States of America.

Wescor, Vapro, Optimol, Osmocoll and
Blow Clean are trademarks of Wescor, Inc.

Other trade names used in this manual
may be trademarks of their respective
owners, used here for information only.

The information in this manual may
change without prior notice.

SECTION

1 INTRODUCTION

1.1 User's Manual Overview	7
1.2 Customer Service	8
1.3 Vapro System Description	9
1.4 How the Vapro Works	10
1.5 Controls and Features	12

SECTION

2 GETTING STARTED

2.1 Instrument Setup Sequence	17
2.2 Vapro Accessories	18
2.3 Setting Up the Osmometer	19
2.4 Micropipettor Information	22
2.5 Using Optimol [®] Osmolality Standards	24
2.6 Using Osmocoll [®] HNL Serum Control	26
2.7 Changing the Voltage Selector.....	27
2.8 Changing Fuses	28

SECTION

3 OPERATING THE VAPRO OSMOMETER

3.1 Operation Overview	29
3.2 Loading Samples	34
3.3 Cleaning the Sample Holder.....	39
3.4 Running the Clean Test.....	40
3.5 Calibrating	41
3.6 Standby or Waiting Periods	43
3.7 Serial Data Output	44

TABLE OF CONTENTS

SECTION

4
PREVENTIVE MAINTENANCE

4.1 Preventive Maintenance Overview	45
4.2 Removing the TC Head	46
4.3 Cleaning the TC Head	48
4.4 Reinstalling the TC Head	51
4.5 Equilibration After Cleaning	53
4.6 Severe or Stubborn Contamination	54

SECTION

5
SOLVING PROBLEMS

5.1 Troubleshooting	57
5.2 Common TC Head Problems	65
5.3 External Factors Affecting Precision	68
5.4 Deformed or Broken Thermocouple	69

APPENDIX A

Instrument Specifications	71
---------------------------------	----

APPENDIX B

Accessories, Supplies, and Replacement Parts	73
--	----

APPENDIX C

Theory of Operation	75
---------------------------	----

APPENDIX D

Special Application Notes	81
---------------------------------	----

TABLE OF CONTENTS



APPENDIX E	
Osmolality Standards	91
APPENDIX F	
Serial Data Output	93
APPENDIX G	
Setup Menu	95
INDEX	97



1.1 User's Manual Overview

Thank you for purchasing the Vapro[®] vapor pressure osmometer. You will find it to be a valuable investment and an important partner in the laboratory.

The Vapro User's Manual is your key to efficiently operating this instrument. We recommend that you become thoroughly familiar with the operation procedures and troubleshooting techniques described in this manual.

Information is presented in a step-by-step format to demonstrate the operation and care of the instrument from a first-time user's point of view. Once you become familiar with the operation of the Vapro osmometer, the manual will help you maintain the instrument in a high state of precision and reliability.

SPECIFICATION OF SAFE USE:

Using this instrument in a manner not specified by Wescor may impair the safety protection designed into the equipment and may lead to injury.

SAFE USE ENVIRONMENT:

This equipment is designed to be safely operated at 15 to 35 °C, maximum relative humidity 80%.

FUSE: All fuses in this equipment are time-lag (Type T).

EXPLANATION OF SYMBOLS FOUND ON EQUIPMENT:

~ Alternating Current (AC)

I Power On

O Power off

⚠ International Attention Symbol. Calls attention to important information and instructions in the instruction manual.

1.2 *Customer Service*

Wescor is ready to help resolve any difficulty with the operation or performance of your Vapro osmometer. If you cannot solve a problem using the procedures in this manual, please contact us.

Customers within the United States are encouraged to contact us by telephone. Outside the U.S., many of our authorized dealers offer complete customer service and support. Contact Wescor by mail, telephone, or fax at the address and numbers listed below.

WESCOR, INC
459 South Main Street
Logan, Utah 84321-5294
USA

TELEPHONE

435 752 6011

Extension 0 - Operator
 171 - Orders
 172 - Service

TOLL FREE (U.S. and Canada)

800 453 2725

Extension 0 - Operator
 171 - Orders
 172 - Service

FAX

435 752 4127

E-MAIL:

service@wescor.com

WEB SITE:

www.wescor.com

1.3 *Vapro System Description*

The Vapro osmometer is an advanced electronic adaptation of the hygrometric method of vapor pressure determination. The sensitive thermocouple and sophisticated electronics provide the means to measure the dew point temperature depression of a specimen with resolution to 0.00031 °C (which equals 1 mmol/kg).

Vapor pressure and freezing point are among the colligative properties of a solution. Compared with pure solvent, these properties are altered in proportion to the number of solute particles dissolved in each kilogram of solvent (water in the case of biological solutions). Thus, measuring either property is an indirect means of determining solution concentration or osmolality.

The chief advantage of the vapor pressure method is that it does not require alteration of the physical state of the specimen. Concomitant benefits include:

- 10 microliter sample size.
- Routine operation on micro samples of any biological solution, including whole blood, serum, plasma, urine, and sweat, as well as complex specimens such as tissue samples.
- None of the measurement artifacts that arise in freezing point depression measurements due to elevated viscosity, particulate matter, inhomogeneities, or other physical characteristics of the sample.
- Superior reliability because the measurement involves minimal mechanical complexity.

NOTE:

Vapro displays in Standard International (SI) units: mmol/kg. See Appendix E.

1.4 *How the Vapro Works*

A 10 microliter specimen is aspirated into a micropipettor tip. The specimen is then inoculated into a solute-free paper disc in the sample holder, whereupon the sample holder is pushed into the instrument and the sample chamber is locked. Locking initiates the automatic measurement sequence.

The sensing element is a fine-wire thermocouple hygrometer. This is suspended in a unique, all-metal mount, which when joined with the sample holder, forms a small chamber enclosing the specimen.

As vapor pressure equilibrates in the chamber airspace, the thermocouple senses the ambient air temperature, thus establishing the reference point for the measurement. Under electronic control, the thermocouple then seeks the dew point temperature within the enclosed space, giving an output proportional to the differential temperature.

The difference between the ambient temperature and the dew point temperature is the dew point temperature depression—an explicit function of solution vapor pressure.

Dew point temperature depression is measured with a resolution of 0.00031 °C. The microprocessor-controlled measurement cycle requires 80 seconds.

Appendix C contains the theory of operation of the vapor pressure osmometer.

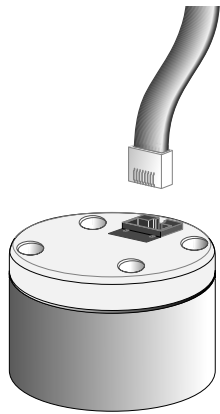

TC Head and Connector

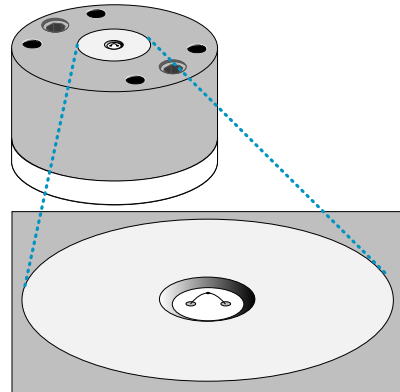

Thermocouple and TC Mount

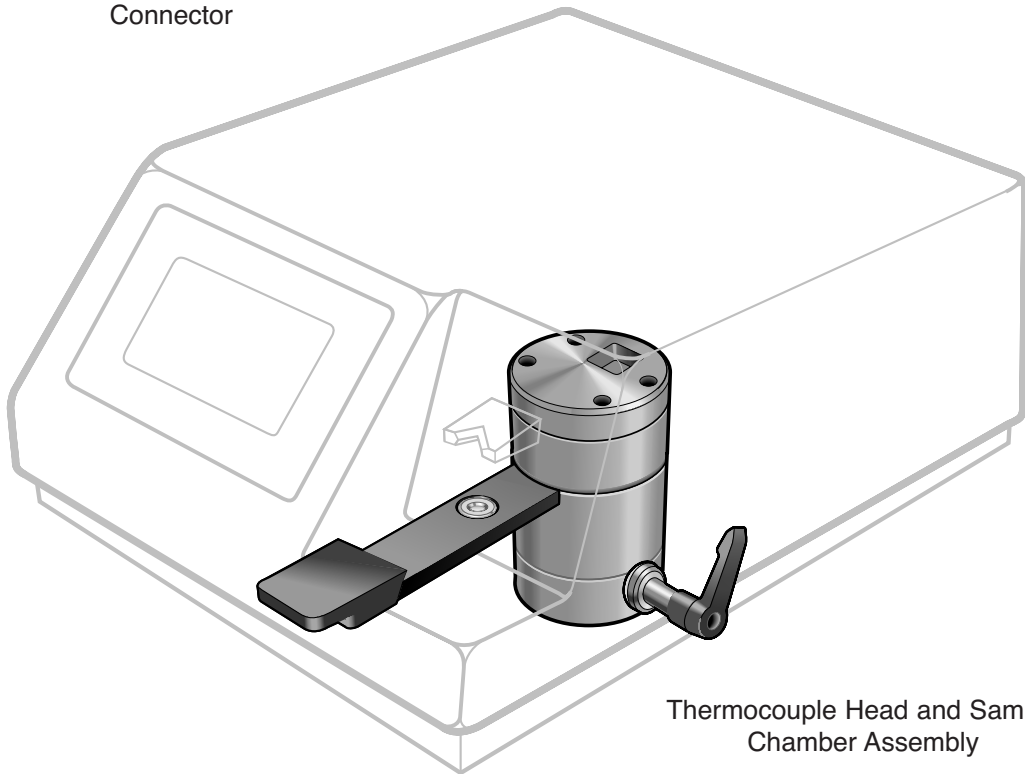

Thermocouple Head and Sample Chamber Assembly

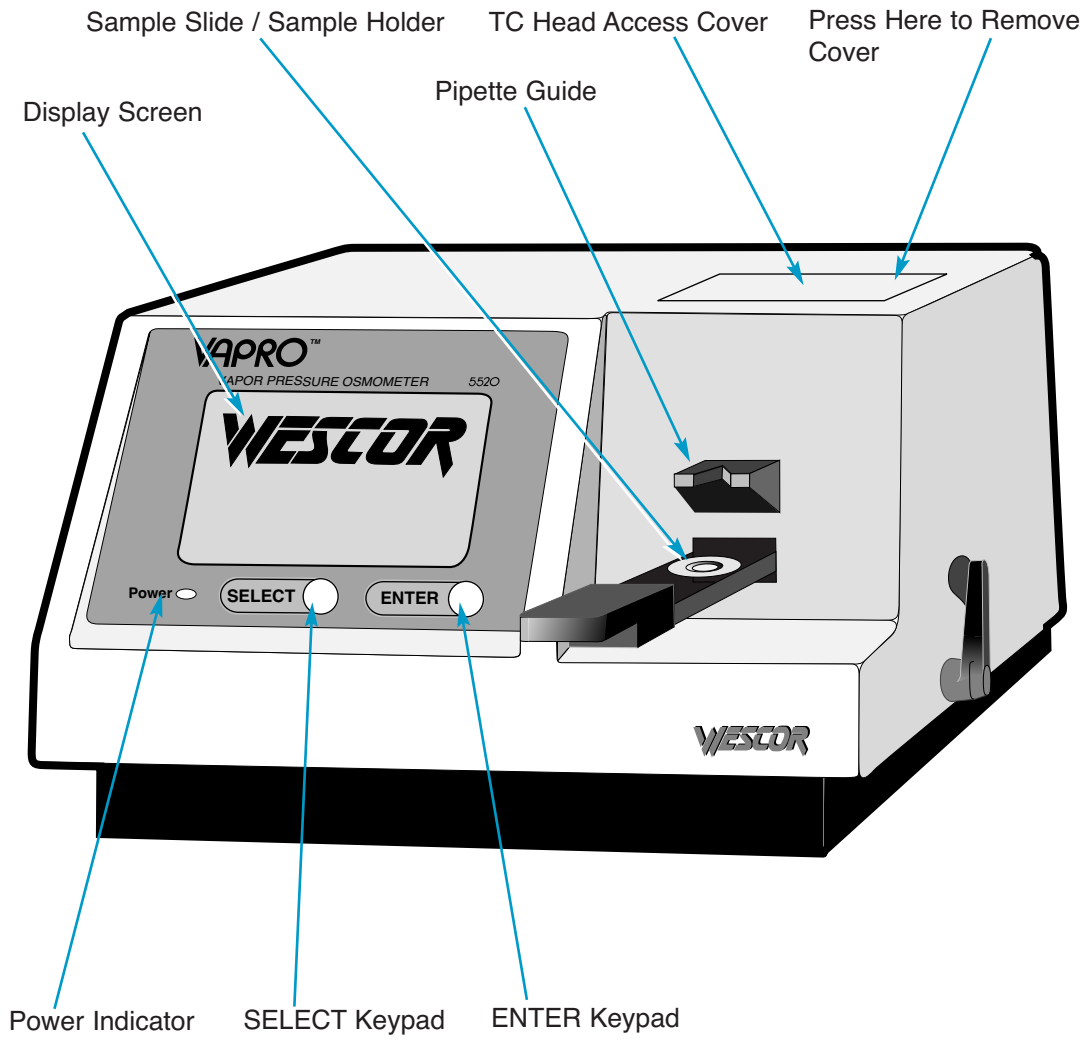

1.5 Controls and Features

INSTRUMENT FRONT PANEL

Display Screen

10 x 7 cm LCD. Displays menu selections, osmolality readings, countdown of measurement time in seconds, operating status, fault conditions, and other information.

SELECT Keypad

Press to call up menus and to select operation mode.

ENTER Keypad

Press to engage a selected menu item or operation mode.

Pipette Guide

Aligns and steadies the pipette for precise application of the specimen onto the sample disc in the sample holder.

Sample Holder

Standard sample holder for samples up to 10 microliters in volume. Requires solute-free paper discs (provided) for use. Other sample holders are available for special applications (see Appendix B and D).

Sample Slide

Moves the sample holder from the loading position (under the pipette guide) to the sample chamber.

Power Indicator

The green light indicates the instrument is on.

INSTRUMENT TOP

TC Head Access Cover

Provides access to thermocouple head for cleaning and maintenance. Press down on the right side of the cover to remove.

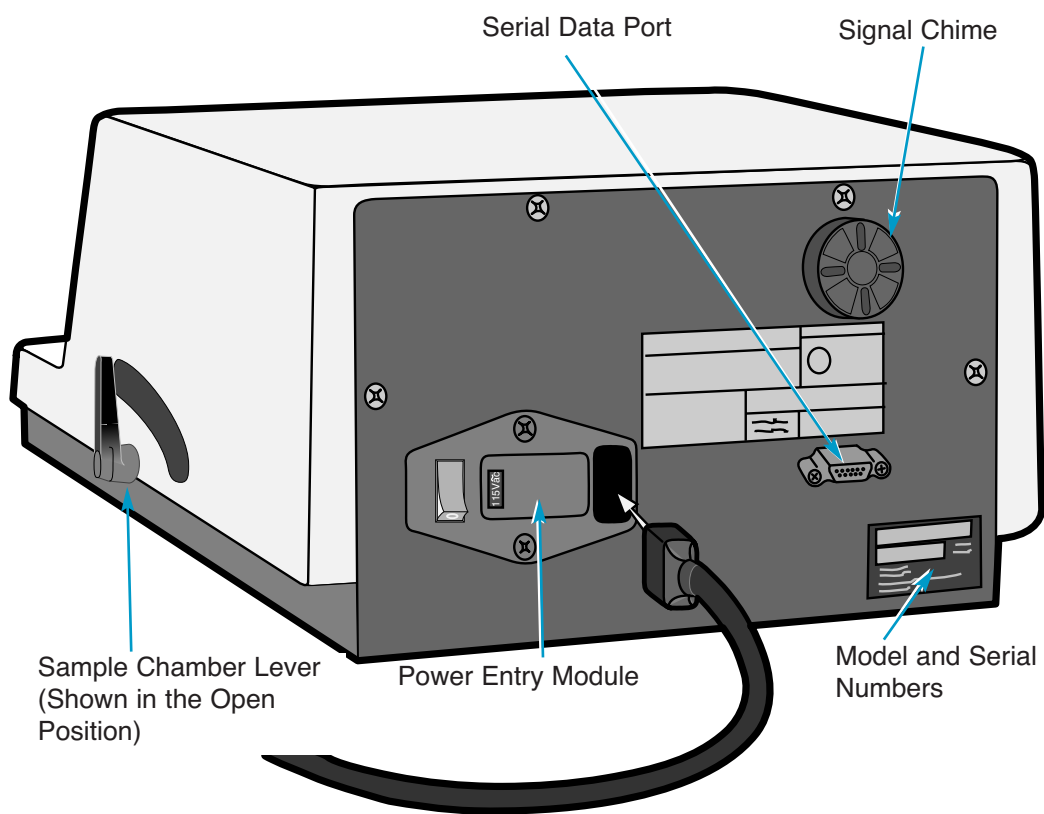

1.5 Controls and Features

INSTRUMENT RIGHT SIDE

Sample Chamber Lever

Opens and closes the sample chamber. Closing the sample chamber locks the sample holder within the chamber. The chamber should remain closed, except when loading or removing samples. Closing the chamber initiates the measurement cycle or the “Standby” mode (indicated by READY on the display screen) if no sample is present.

INSTRUMENT INTERIOR

The thermocouple (TC) head and thermocouple head connector are accessed by removing the chamber access cover from the top of the instrument.

INSTRUMENT REAR PANEL

Signal Chime

Sounds a short chime at the conclusion of each measurement cycle and a long chime when certain fault conditions exist. Turn the shutter wheel to adjust volume.

Serial Data Port

For asynchronous serial communication with a printer or computer. The serial port uses a DB9 connector at RS-232 voltage levels. See Appendix F for more information.

1.5 Controls and Features

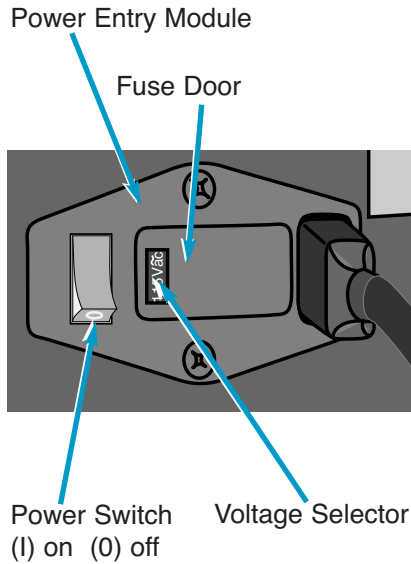

INSTRUMENT REAR PANEL (Continued)

POWER ENTRY MODULE

Accepts standard IEC 320 type power cord.

Fuse Door

Provides access for fuse replacement. See Section 2.8 for instructions.

Power Switch

Switches power on (I) or off (O).

Voltage Selector

This selector is set at the factory. If necessary, you can set the selector to match your local power source (see Section 2.7). Fuses must match the voltage selection. To change fuses, see Section 2.8 and Appendix A.

WARNING!

Using this equipment in a manner not specified by Wescor may impair the provided safety protection.

2.1 Instrument Setup Sequence

We recommend that you follow this sequence if you are using this instrument for the first time. Details about these operations are found in the following sections.

✓ List

1. Inspect accessories and supplies.
2. Place the instrument on a suitable work surface in an area free from drafts.
3. Plug in the power cord and switch power on.
4. Allow for temperature equilibration (observe Temperature Drift Scale).
5. Practice loading samples.
6. Calibrate the instrument.
7. Perform a Clean Test and clean the thermocouple if necessary.
8. Check instrument calibration and recalibrate if necessary.
9. Assay samples.

2.2 Vapro Accessories

The following accessories and supplies are furnished with the Vapro osmometer:

Vapro User's Manual
Micropipettor
Micropipettor Disposable Tips
Forceps
Paper Sample Discs
Opti-Mole[®] Osmolality Ampule Standards
Ampule Organizer
9/64 inch Hex Driver
Thermocouple Head Cleaning Supplies, consisting of:
 Cleaning Solution
 Deionized Water
 Blow Clean[™]* (U.S. 48 states only)
 Thermocouple Cleaning Solution with Anionic Detergent

In addition to the above, you need a supply of lint-free tissue paper or cotton swabs for cleaning the sample holder between specimens.

CAUTION!

Never use facial or other soft tissue to clean the sample holder. Such tissues produce excessive lint residue that will contaminate the thermocouple sensor.

* Compressed or liquefied pure gas suitable for blowing dust from delicate surfaces or precision mechanisms. Available under various trade names.

2.3 Setting Up the Osmometer

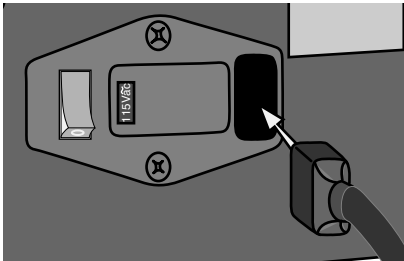

Carefully unpack the instrument and compare the contents with the packing list to be certain that everything needed for operation is at hand.

- 1 Place the osmometer on a suitable work surface.

NOTE:

Avoid locations where instrument precision will be altered by thermal gradients or rapid temperature changes caused by heavy foot traffic, air vents, blowers, heaters, or windows.

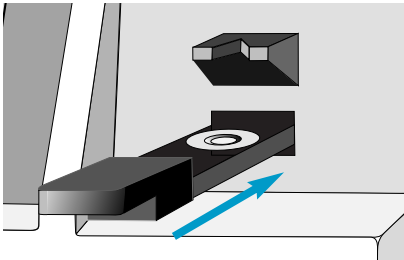

- 2 Connect the power cord to an electrical outlet that matches the voltage selected on the rear panel. Avoid power circuits that are shared by centrifuges, air conditioners, or other power equipment. We recommend that you use a power line surge protector to isolate the osmometer from spikes and surges.

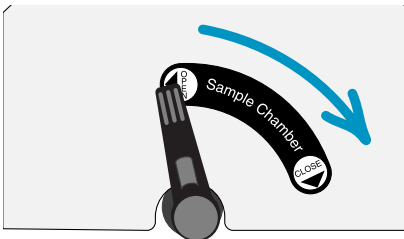

- 3 Verify that the sample holder is in the measurement position (sample slide is pushed completely into the instrument until it stops).

- 4 Verify that the sample chamber lever is in the closed position.

TURN PAGE TO CONTINUE INSTRUCTIONS

2.3 Setting Up the Osmometer

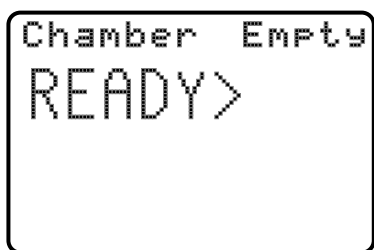
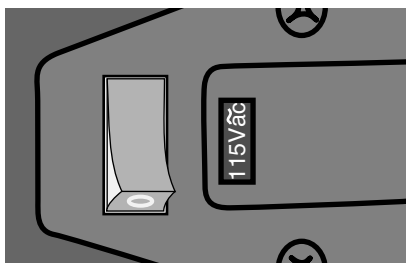

- 5 Turn the osmometer on (I). The **POWER** indicator on the front panel shows green when power is on.

The display screen will briefly show the Wescor logo, language and unit selection, and the resident software version. This will be followed by the word “initialization” with a countdown timer.

To change the displayed language or units of measure, see Appendix G, Setup Menu.

NOTE:

If you open the chamber lever before the end of the initialization cycle, the warning chime sounds.

The initialization cycle establishes the reference point for the instrument. When the initialization cycle is complete, the display screen will appear as shown on the left.

NOTE:

Even though the screen at this point indicates the instrument is ready, calibration will not be stable until the instrument reaches thermal equilibration (see below).

Temperature Drift Scale

Osmolality determination involves the measurement of extremely small temperature differentials. The osmometer is thus sensitive to ambient temperature changes which induce internal temperature changes.

2.3 Setting Up the Osmometer

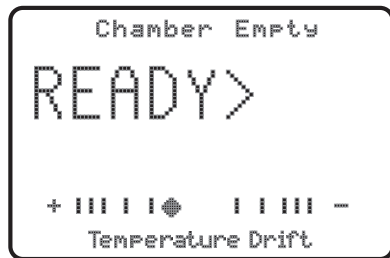

While the instrument compensates for small changes that occur over time, moving the instrument to a different area or exposing it to too much air circulation will shift the osmometer's reading and calibration points. The Temperature Drift scale allows you to determine when internal temperature has stabilized.

The Temperature Drift scale appears on the screen whenever the instrument is in the "standby" mode, and it has completed two cycles. The instrument is considered stable and ready to operate unless the indicator is against the + or - marks on the scale, indicating a changing internal temperature that can affect instrument calibration. See Note below:

NOTE:

It is normal for the osmometer to undergo a significant temperature drift during the first few minutes of equilibration. The time required to achieve temperature stability depends on the initial instrument temperature, (typically 10 to 30 minutes) but may be longer if initial temperature varies more than 5 degrees from room temperature.

NOTE:

Under normal circumstances, leave power on to keep the instrument in a ready state and to maintain stability. (See Section 3.6)

2.4 *Micropipettor Information*

The micropipettor furnished with the Vapro osmometer uses a two-step (aspirate/expel) mechanism that dispenses 10 microliters of liquid for osmolality assay. This no-maintenance micropipettor works with a wide range of biological solutions and laboratory reagents. Disposable plastic tips eliminate carry-over error from sample to sample. Use the provided micropipettor to assure uniform results among different operators.

We do not recommend three-step pipetting (aspirate/expel/blowout) for loading the osmometer. The blowout step tends to create bubbles in the specimen that can lead to thermocouple contamination.

Positive Displacement Pipettors

A positive-displacement pipetting device or alternative loading methods may be more suitable for extremely viscous fluids or complex specimens.

CAUTION!

Do not use positive displacement pipetting devices for routine operation. Refer to Appendix D for additional information regarding special applications.

The sample loading procedure in this manual presumes the use of the Wescor micropipettor.

2.4 *Micropipettor Information*

Sample Volume Considerations

The Vapro osmometer does not demand a high degree of volumetric accuracy at the 10 μL sample level. Sample volume variations of ± 10 percent will not noticeably affect the final result. Gross volumetric errors, such as might arise from incorrect pipetting technique or poorly maintained micropipettors, or micropipettors not approved by Wescor, can cause significant measurement errors.

2.5 Using Optimol Osmolality Standards

Wescor's Opti-Mole[®] ampule osmolality standards are accurate enough to satisfy the most stringent quality assurance requirements. Calibration integrity is assured because ampules provide fresh solution for each use. Having the accuracy of reference standards, Optimol standards are ideal for routine osmometer calibration. Optimol standards are manufactured under strict quality control and have a minimum storage life of 36 months. Refer to Appendices B and E for more information.

NOTE:

Ampule standards are intended for one-time use for no more than a few hours. When you have finished calibration, discard any remaining solution.

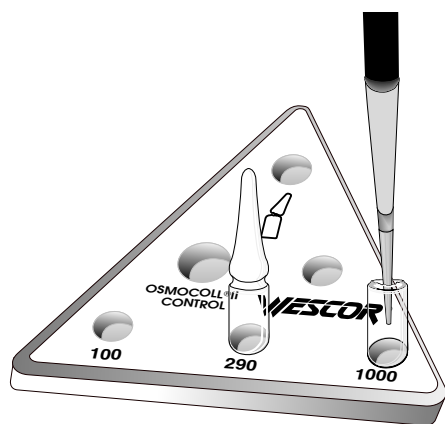

Instructions

Each ampule contains 0.4 mL of solution. This volume is sufficient to prevent measurable evaporative concentration for a few hours after the ampule is opened.

- 1 Flip the stem of the ampule with your finger, or tap the ampule lightly against a hard surface to dislodge any solution held by capillary action in the stem of the ampule.
- 2 Place the ampule in the breaker position of the Ampule Organizer. Hold the organizer firmly down against the work surface.
- 3 Slide the provided flexible protection sleeve over the stem of the ampule.
- 4 Grasp the sleeved stem firmly and snap the neck of the ampule.

2.5 Using Optimol Osmolality Standards

- 5 Sample directly from the ampule, using a fresh micropipettor tip each time to avoid contamination of the solution.
- 6 Discard any solution that remains after finishing your calibration procedures.

Optimol standards are packaged in 60-ampule cartons designed for convenient shipment and storage. See Appendix B for ordering information.

Assuring Accurate Measurements

The accuracy of reported osmolality is directly linked to the accuracy of the calibrating standard solutions. While these solutions have exact specified osmolality at the time they are opened, osmolality inevitably increases as water evaporates.

Always adhere to the following guidelines when using Optimol ampule standards:

- Since the specified value of osmolality is certain only at the time the ampule is opened, do not rely on any opened ampule if you are uncertain of how long its contents have been exposed to evaporation.
- Sample directly from the ampule—do not transfer standard solution from ampules to other containers.
- Always follow the instructions in Section 3.5 to calibrate your Vapro osmometer, and always verify calibration prior to running any unknowns.

See Appendix E for more information.

2.6 Using Osmocoll HNL Serum Control

Osmocoll[®] HNL (SS-039) is a processed, stabilized bovine serum control, which is useful in a quality assurance program for the Vapro osmometer. See Appendix B for more information.

For optimum results, always adhere to the following guidelines:

- Upon arrival in your laboratory, refrigerate Osmocoll HNL. Under refrigeration, the serum will remain stable until the labeled expiration date.
- Once opened, the product has a maximum stable life of 5 days, if kept refrigerated and tightly capped, however **the solution must be at room temperature before running in the osmometer.**

CAUTION!

Never calibrate the Vapro osmometer using Osmocoll HNL control solution.

Instructions

- 1 Run a sample of Osmocoll HNL control.
- 2 If the measured osmolality falls outside of the range listed on the package labeling (each Osmocoll lot is assayed for osmolality), you should suspect the calibration of the instrument. Recalibrate the instrument using freshly opened Optimol ampule standards. See Section 3.5 for instructions.

2.7 Changing the Voltage Selector

The voltage selector is set at the factory. If the voltage shown does not match your power outlet (see Appendix A for nominal voltage ranges), you must change the voltage selector before plugging the instrument into the outlet. To change the voltage selector:

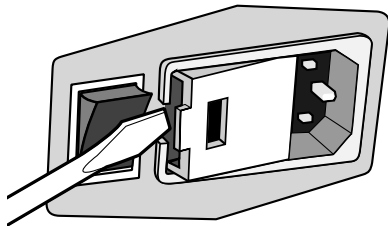
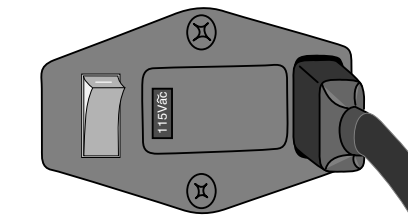

115Vac / 230Vac

- 1 Switch the power off and remove the power cord from the power entry module.
- 2 Use a screwdriver to open the fuse door from the switch (left) side.
- 3 Pull the voltage selector away from the mounting slots.
- 4 Rotate the indicator until the correct voltage is facing directly outward, then press it back into the slots.
- 5 Change the fuses to match the new voltage setting. See Section 2.8 for fuse replacement instructions.
- 6 Close the fuse access door and verify that the correct voltage now appears in the indicator window.

2.8 Changing Fuses

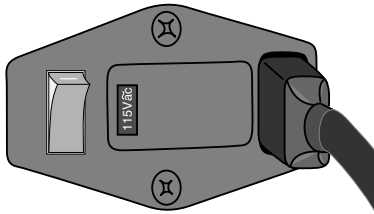

To access the main fuses:

- 1 Turn power off and disconnect the power cord.
- 2 Use a small screwdriver to open the fuse door.

WARNING!

For continued protection against fire hazard, only use fuses of the correct type and rating.

Fuse Specifications:

115 V Setting: 1/8 ampere time-delay type, 1/4" x 1-1/4" (2 required). 230 or 240 V setting: 1/16 ampere time-delay type, 1/4" x 1-1/4" (2 required).

Refer to Specifications (Appendix A).

- 3 Pull fuse holder out. (Note the orientation of the voltage rating, the fuse holder must be replaced with the correct voltage showing in the window.)
- 4 Remove faulty fuse and replace with new fuse of the correct rating.
- 5 Replace fuse holder with the correct voltage orientation.

3.1 Operation Overview

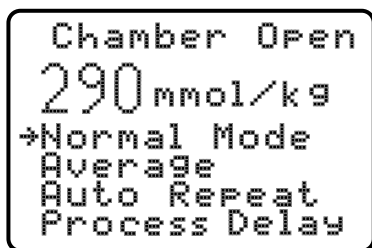

Mode Menu

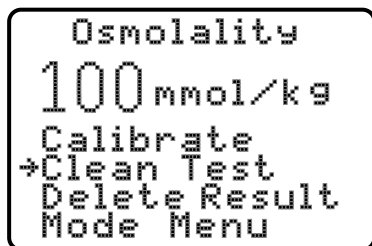

Function Menu

Menu Selections

Two main menus (Mode and Function) are used to select modes and functions of the osmometer. Modes control how the osmometer processes samples and displays results. Use the Mode Menu to select the mode before loading a sample, or immediately after running a prior sample but before opening the sample chamber. After you select a mode, all samples are processed in that mode until you select a different mode. Functions are specific actions the osmometer can perform. The Function Menu is not available until you have assayed a sample.

Press SELECT to move the selection arrow on the display. Press ENTER to activate the selected menu item. If you continue to press SELECT the arrow will return to the top of the menu.

MODE MENU

The Mode Menu appears upon opening the chamber while the instrument is in the “standby” mode (the instrument has cycled on an empty chamber), or when you select Mode Menu from the Function Menu, or when you press SELECT while the chamber is open.

When you activate the Mode Menu, the arrow points to the current mode. When you close the chamber, or press ENTER with the chamber closed, the instrument executes the sample measurement in the selected mode. You can change the mode at any time before the measurement cycle begins, or on the last sample before the sample chamber is opened. To activate the Mode Menu after a sample has been run, either select Mode Menu from the Function Menu or open the chamber and press SELECT.

3.1 Operation Overview

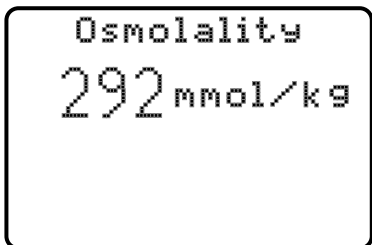

Normal Mode

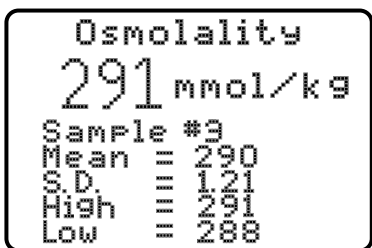

Average Mode

The modes are described below.

Normal Mode

For routine running of single samples. Does not display any statistical data. This mode is the default setting upon power-up of the instrument.

Average Mode

Will run single samples while maintaining statistical data on up to 32 samples. These data include the number of samples run (1 to 32), mean, standard deviation, highest result and lowest result.

NOTE:

If a 33rd sample is run, the result will displace the first sample, a 34th sample will displace the second sample, and so on. The statistical evaluation will always be based upon the latest 32 samples, if more than 32 samples are assayed.

Average Mode is useful when you need the best possible accuracy. When the instrument is calibrated in Average Mode, calibration is adjusted to the mean value of the assayed samples. Calibration resets the operation mode to Normal Mode (see Section 3.5).

NOTE:

We recommend calibrating in Average Mode using 3 or 4 samples of each calibrating solution value.

To restart a new set of precision values, bring up the Mode Menu (the arrow should be pointing at Average Mode). The next sample assayed will be sample #1 in the data group. Or, select the Mode Menu immediately after running a sample, before opening the chamber. Select Average Mode and press ENTER. The last sample assayed will be #1 in the data group.

3.1 Operation Overview

```
Sensor Drying
999 mmol/kg
```

```
Osmolality
998 mmol/kg
Sample #5
Mean = 999
High  = 1000
Low   = 998
```

Auto Repeat Mode

```
Process Delay
310 mmol/kg

Press ENTER
To Start Cycle
```

Process Delay Mode

Auto Repeat Mode

Checks the repeatability of the osmometer on the same sample. The instrument will automatically run 10 consecutive measurements on the sample, (usually a 1000 mmol/kg Optimol sample) and display the statistical data. Since the chamber is not opened between measurements as in other modes, a short delay occurs between each measurement while water evaporates from the thermocouple. During this time the display screen shows "Sensor Drying."

Low osmolality samples (below 200 mmol/kg) may show a difference between the first and any subsequent readings if the chamber is contaminated (see Section 3.4).

The Auto Repeat sequence can be interrupted at any point simply by opening the sample chamber.

Process Delay Mode

Complex samples (such as leaf and other samples from which water may not readily evaporate) require long periods to reach vapor equilibrium. Process Delay Mode delays the measurement cycle after you close the chamber until you press ENTER. In research applications, this lets you delay measurement until vapor equilibrium is achieved. The measurement can be repeated without opening the chamber and to avoid vapor loss. See Appendix D for more information.

3.1 Operation Overview

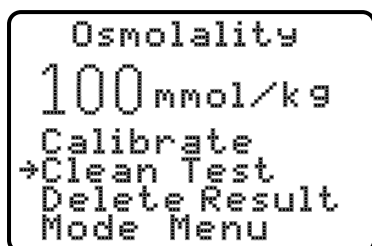

Function Menu

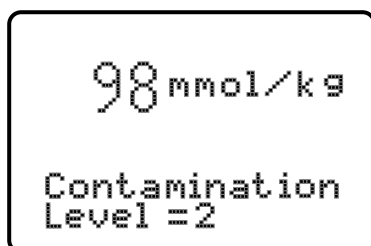

FUNCTION MENU

To display this menu, press SELECT after a sample has been assayed, and before opening the sample chamber. The osmometer performs the function indicated by the arrow when you press ENTER.

Calibrate Function

Use this function to calibrate the instrument using the 290, 1000, and 100 mmol/kg calibration standard. Always begin with the 290 set point, then follow with the 1000 and 100 mmol/kg. See Section 3.5 for details.

Clean Test

The Clean Test consists of two consecutive sample assays on a 100 mmol/kg standard solution. The difference between the first and second assay indicates the degree of contamination in the sample chamber.

Run this test if you notice significant changes in the 100 mmol/kg calibration level.

Always use the Clean Test to check thermocouple cleanliness before assaying samples which require good linearity and accuracy in the low range. After thermocouple cleaning, calibrate the instrument with the 290, 1000, and 100 mmol/kg standards. Use the Clean Test to verify the effectiveness of the cleaning.

We recommend that you perform this test on a routine basis before each osmometer use session. This will allow you to monitor the condition of the thermocouple sensor and the rate at which contamination builds up in the sample chamber. See Section 3.4 for instructions.

3.1 *Operation Overview*

Delete Result

Deletes the last result from the data group. You can delete multiple results using this function. This function can only be used while operating in Average Mode.

Returning to Mode Menu

Press ENTER while the arrow points at MODE MENU to exit the Function Menu and return to the Mode Menu.

NOTE:

Calibration is a critical element of instrument accuracy. While it is not necessary to calibrate the osmometer while familiarizing yourself with it, you should check calibration before you assay sample material (see instructions in Section 3.5).

3.2 Loading Samples

When first using the Vapro system, practice the loading procedure using the micropipettor and the 290 mmol/kg standard. Record the value displayed at the end of the cycle, when the “In Process” display goes out and the chime sounds. Practice this procedure until you can obtain sequential results with a spread of less than 6 mmol/kg. Consistent timing during loading is important for optimum repeatability. This will come naturally after a few samples.

NOTE:

While you practice, do not be concerned if the instrument readings do not agree with the specified concentration of the solution. When you feel comfortable with the procedure and are able to obtain repeatable results, calibrate the instrument using the instructions in Section 3.5, then run the Clean Test (Section 3.4).

Sample Volume

The optimum sample volume (10 microliters) should fully saturate one of the SS-033 sample discs. The osmometer accommodates variations in sample volume as great as ± 10 percent (9 microliters to 11 microliters) without noticeable variation in indicated osmolality.

CAUTION!

Samples greater than 11 microliters can contaminate the thermocouple.

3.2 Loading Samples

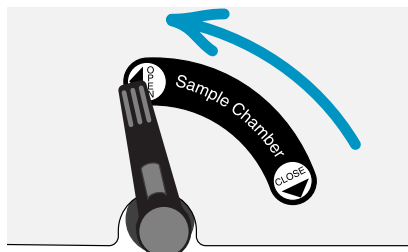

Open the Sample Chamber

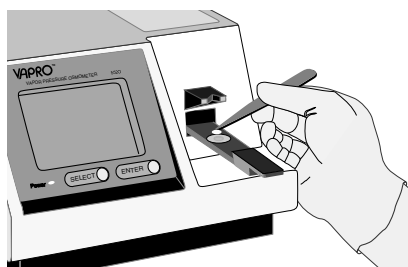

Place Sample Disc in Sample Holder

Sample Loading Procedure

- 1** Rotate the sample chamber lever upward and pull the sample slide out from the instrument until it comes to a stop, bringing the sample holder directly under the pipettor guide.
- 2** Use the forceps supplied with the instrument to place a single sample disc in the central depression of the sample holder. Make sure you have picked up only a single disc. If necessary, use the forceps and a teasing needle to separate discs. If two discs stick together, the reading will be slightly elevated. Reject imperfect discs or any that do not lie flat.
- 3** With a clean tip installed, aspirate a sample into the micropipettor by depressing the plunger to the stop, immersing the tip, and gently releasing the plunger.

NOTE:

Normally, sample droplets will not cling to the outside of the tip. If they do, they can usually be removed simply by dragging the tip against the lip of the container as you remove it. Occasionally a clinging droplet may have to be removed with a tissue, but be very careful not to wick solution out of the tip.

3.2 Loading Samples

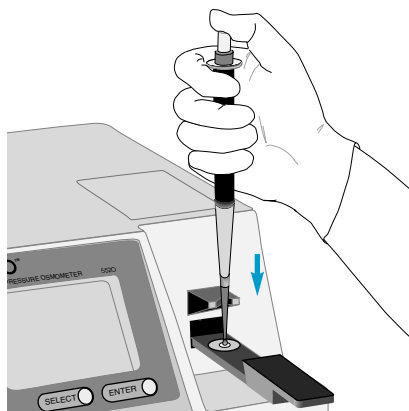

4 With the pipettor tip resting in the notch of the pipettor guide, position the tip about 5 millimeters above the center of the sample disc.

5 Smoothly depress the micropipettor plunger to the stop. The specimen may drop onto the sample disc. Whether the sample droplet falls onto the disc or clings to the tip, you must complete Step 6.

CAUTION!

Never allow the micropipettor tip, sample material, or the wet disc to touch the outer surface of the sample holder. If this occurs, abort the measurement and wipe the sample holder clean before proceeding.

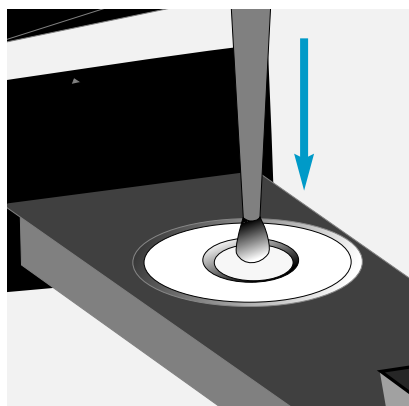

Touch Tip to Sample Disc,
Press Disc Flat.

CAUTION!

Break any air bubbles on the sample disc before proceeding. A bubble bursting inside the sample chamber will contaminate the thermocouple.

6 With the plunger still held against the stop, lightly touch the micropipettor tip to the sample disc, then lift it away. The tip must briefly contact the sample disc to press it flat against the holder. The paper disc should appear fully saturated, with a slight liquid meniscus on its surface.

3.2 Loading Samples

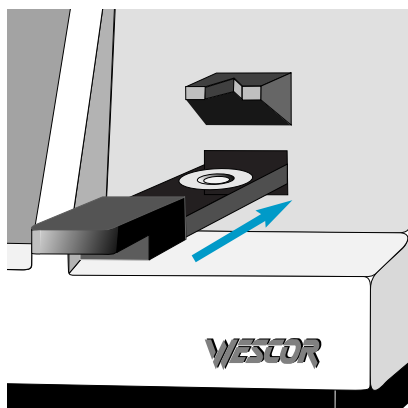

7 Gently push the sample slide into the instrument until it stops. (Never close the chamber unless the sample holder is in this position.)

8 Grasping the sample chamber lever between thumb and forefinger, rotate it smoothly to the closed position.

NOTE:

Since the sample may concentrate slightly before the chamber is sealed, steps 5 through 8 should be performed with consistent timing. A warning chime sounds if the chamber is left open longer than 2 minutes.

Closing the lever starts the measurement cycle. The display screen shows "In Process" and counts down the remaining time:

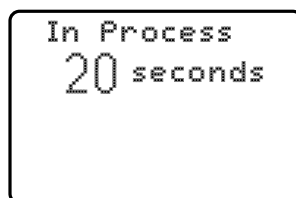
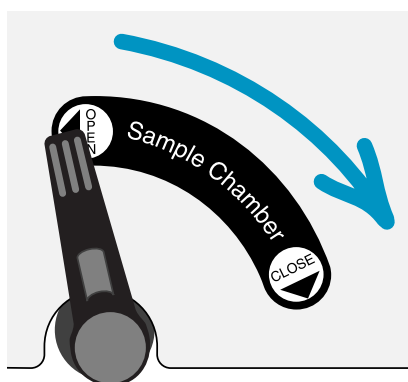

When the measurement is completed, the chime sounds. The display screen shows the osmolality of the specimen:

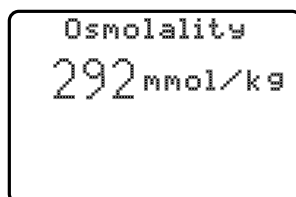

3.2 Loading Samples



The display shows this final reading until the chamber is opened and closed once again.

NOTE:

Vapro reports osmolality measurements in Standard International (SI) units: mmol/kg.

CAUTION!

During long, uninterrupted measurement periods, occasionally allow the instrument to return to the “standby” mode by initiating an operating cycle on an empty chamber. This is necessary for the instrument to readjust itself to any temperature change that may have occurred during the interval. Failure to do this can cause unwanted calibration shifts. See Section 3.6.

- 9 Remove the specimen from the sample chamber immediately after a measurement using the instructions in Section 3.3. If the sample is left in the chamber for longer than 4 minutes, a warning chime will sound.

CAUTION!

You can severely contaminate the chamber (or the thermocouple) in a single loading if you improperly load the sample or if you fail to thoroughly clean the sample holder. Severe contamination can make it impossible to calibrate the osmometer.

3.3 *Cleaning the Sample Holder*



Remove Sample and
Clean Sample Holder

To clean the sample holder and prepare for another sample:

- 1 Smoothly rotate the chamber lever to the open position, then withdraw the sample slide.
- 2 Using a lint-free tissue (not facial tissue) or a cotton swab, carefully remove the wet disc and any traces of residual liquid from the sample holder.

CAUTION!

Never use metal forceps to remove wet discs; this can damage the surface of the sample holder.

- 3 Leave no visible residue on the holder surface. If needed, use a tissue or swab moistened with deionized water. Always clean the sample holder with a fresh tissue or swab to avoid contamination. Avoid touching the sample holder with bare fingers.

The sample holder should appear bright, shiny, and perfectly dry before loading the next specimen.

NOTE:

Regularly perform the Clean Test using the instructions in Section 3.4.

3.4 Running the Clean Test

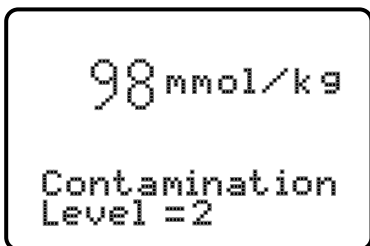
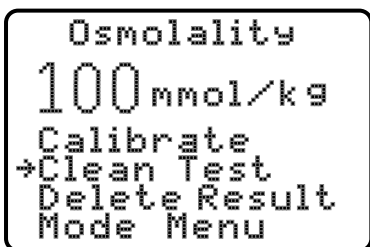

The Clean Test is a diagnostic feature that compares two consecutive sample assays and uses the difference to determine the contamination level of the thermocouple.

When To Run the Clean Test

We recommend running the Clean Test before each session of osmometer use, after calibration, or anytime you notice a significant (10 mmol/kg or more) shift in the 100 mmol/kg calibration. Check thermocouple cleanliness before assaying samples that require good linearity and accuracy in the low range. After cleaning the thermocouple, use the Clean Test to verify the effectiveness of the cleaning.

Instructions

- 1 Calibrate the osmometer using the 290 and 1000 mmol/kg standards, then run a 100 mmol/kg standard sample in Normal Mode. Observe the reading. Then **press CALIBRATE**.
- 2 **Before opening the sample chamber**, press SELECT to reveal the Function Menu. Press SELECT again to point the selection arrow at CLEAN TEST.
- 3 Press ENTER. The instrument performs a second assay of the loaded sample and displays the difference between the first and second assay in approximately 2 to 3 minutes.

NOTE:

If the thermocouple fails to dry within 4 minutes, the instrument will report "Check Thermocouple Head." This indicates the presence of a contaminant (a gross contamination or fiber) on the thermocouple that is holding vapor.

If the displayed contamination level is greater than 10, you should perform the thermocouple cleaning procedures found in Section 4.

3.5 Calibrating

For optimum operating accuracy, the instrument must be correctly calibrated according to the instructions in this section. Calibration accuracy depends upon three main factors:

- Standard solution accuracy
- Thermocouple cleanliness
- Loading technique (repeatability)

NOTE:

Use Optimol glass-encapsulated ampule standards for calibration.

Calibrate the instrument using the 290, 1000, and 100 mmol/kg standards, following the initial equilibration period after you first set up the instrument. Thereafter, we recommend that you check calibration before each session of use.

NOTE:

Calibration values are saved by the instrument when power is interrupted.

Instrument Response Characteristics

Most clinical osmolality determinations range from 200 to 1000 mmol/kg. The inherent linearity of the vapor pressure method results in an extremely linear instrument response from 100 mmol/kg to the upper limit of the osmometer's range.

3.5 Calibrating

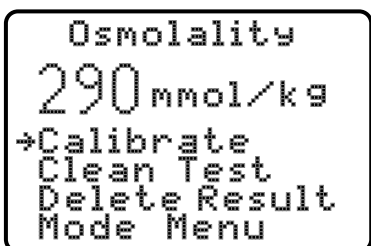
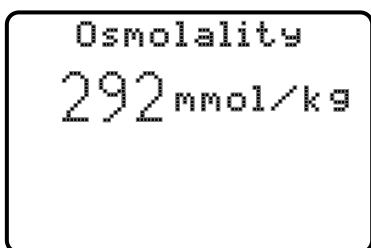

Initial or Routine Calibration

- 1 Run a 290 mmol/kg standard.
If the osmometer reads within ± 3 mmol/kg of the standard (287 to 293), it is within acceptable calibration limits. In that case, skip to Step 4. If calibration is needed, proceed to Step 2.
- 2 With the chamber still closed, press SELECT to reveal the Function Menu. The selector arrow should be pointing at Calibrate.
- 3 Press ENTER. The instrument calibrates to the standard.
- 4 Repeat this sequence using the 1000 mmol/kg and 100 mmol/kg standards to establish baseline calibration for these standards. If the reading is not within ± 5 mmol/kg of the standard value for the 1000 mmol/kg standard, or ± 2 mmol/kg for the 100 mmol/kg standard, perform steps 2 and 3.

Calibration Method for Maximum Calibration Accuracy

When you need maximum accuracy, run the following calibration sequence.

- 1 Select Average from the Mode Menu.
- 2 Run three consecutive assays using 290 mmol/kg standard.
- 3 Select CALIBRATE and press ENTER.

The instrument calibrates on the average of the three samples. This method can also be used for 100 and 1000 mmol/kg standards.

3.6 Standby or Waiting Periods

When the instrument is not in use, leave the cleaned sample holder empty and locked in the measurement position. If the chamber is left open for longer than 2 minutes, a warning chime sounds.



When in the standby mode, the Vapro osmometer is not idle. It continuously monitors its internal operating temperature and compensates for changing ambient temperatures that would otherwise result in calibration changes. It also maintains a continuous balance in its thermocouple control circuitry to ensure convergence of the thermocouple to the precise dew point temperature during the measurement cycle.

These internal functions are necessary to maintain accurate performance. That is why we recommend that the osmometer be left under power when not in use. It is also why long measurement sessions should be interrupted periodically to allow the instrument one full measurement cycle on a dry, empty chamber.

NOTE:

Occasionally, after a series of runs, an osmolality reading appears on the screen after cycling on an empty chamber. This may be due to residual moisture on the sample holder. If this occurs, withdraw the sample slide and thoroughly clean the sample holder using lint-free tissue. Then return the slide to the measurement position and close the sample chamber.

3.7 Serial Data Output



The 5520 serial port uses a DB9 connector on the instrument back panel. This port is for asynchronous serial communication with a printer or computer. It uses standard non-return-to-zero (NRZ) format at RS-232 voltage levels.

The instrument senses when the RTS (pin 7) is active.

When a sample is assayed while a device is connected to the 5520's RS-232 port, the display status line will show:

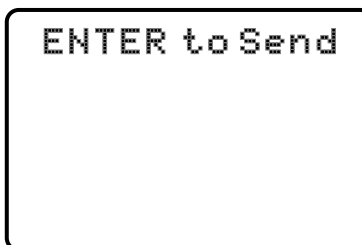

To send data to the external device, press ENTER. The display will show:

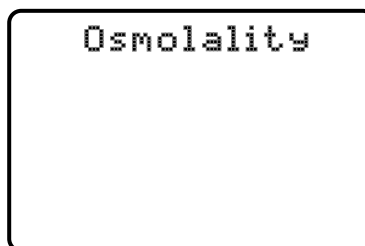

See Appendix F for more information.

4.1 *Preventive Maintenance Overview*

Cleaning the thermocouple (TC) head is the only routine maintenance required by the Vapro osmometer. This section will guide you through the necessary steps of removing, cleaning and reinstalling the TC head. Also included are methods for identifying and resolving more difficult thermocouple contamination situations.

During normal use, dust or lint particles gradually accumulate in the sample chamber. Reasonable care in loading and removing sample material from the sample holder usually makes it possible to run at least 100 assays before cleaning becomes necessary.

Gross contamination is usually a result of incorrect sample loading or incompletely removing sample material from the sample holder following an assay. When correctly operated, sample material will never contact internal chamber parts. See Section 3.2.

Under heavy use, run the Clean Test when the osmometer has assayed 100 samples. Record the results of this test. When the Clean Test shows moderate contamination (Clean Test reading of around 10) try rinsing the TC mount as explained in Section 4.3. If simple rinsing fails to correct the problem, you will need to perform the full cleaning procedure as outlined in Section 4.3.

Cleaning the TC mount as soon as the Clean Test reveals moderate levels of contamination will save time. Cleaning is much more difficult if you wait until contamination interferes with normal calibration settings.

Cleaning the TC head requires removing it from the instrument. Carefully follow directions to safeguard the thermocouple and ensure successful completion of the cleaning process.

4.2 Removing the TC Head

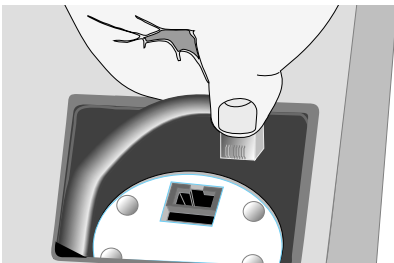
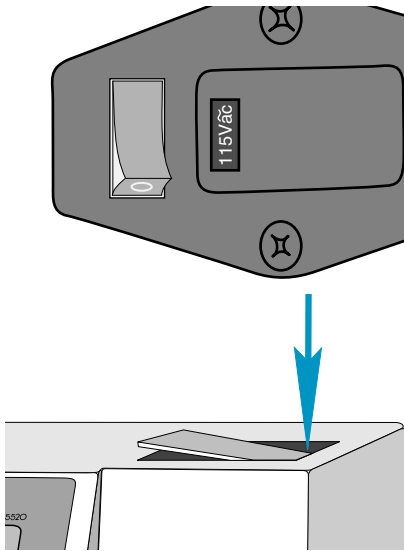

- 1 Turn the power switch off.
- 2 Rotate the sample chamber lever to the open position.
- 3 Remove the TC head access cover from the top of the osmometer by pressing down on the right hand edge, then lifting the raised edge up and away.
- 4 Remove the TC head connector by squeezing the locking tab and lifting.

4.2 Removing the TC Head

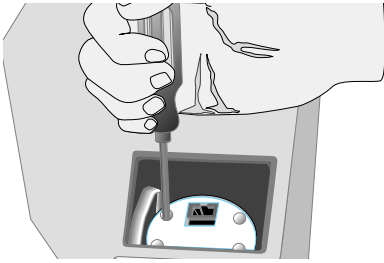

- 5** Using the 9/64 inch hex driver, completely loosen (but do not remove from the TC head) the attachment screws.

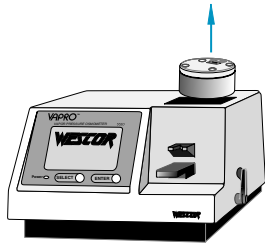

- 6** Grasp the top of the TC head (with the loose attachment screws still in the head) and lift it straight up and out of the instrument. Replace the access cover while the TC head is out of the instrument.

- 7** Remove the attachment screws from the head.

CAUTION!

To avoid thermocouple damage, invert the TC head with the thermocouple facing up, before setting it down.

SECTION 4
PREVENTIVE MAINTENANCE

4.3 Cleaning the TC Head

Materials needed to clean the TC head:

Wescor Cleaning Solution, (SS-003)
Thermocouple Cleaning Solution with Anionic Detergent (SS-223)
Purified Water
Liquid Dropper
Blow Clean Liquefied Propellant or Equivalent.
(Pressure limited to 20 psig.)

NOTE:

To remove significant contamination, use both the Wescor cleaning solutions (SS-003 and SS-223) followed by numerous successive rinses with pure water. Wescor's cleaning solution (SS-003) is approximately 8% ammonium hydroxide. Concentrated ammonium hydroxide can be used to remove particularly stubborn contamination, as described in Section 4.6. The Thermocouple Cleaning Solution with Anionic Detergent (SS-223) removes oily, waxy, or greasy contaminants. Lint or dust particles can usually be removed by simply rinsing with water a number of times.

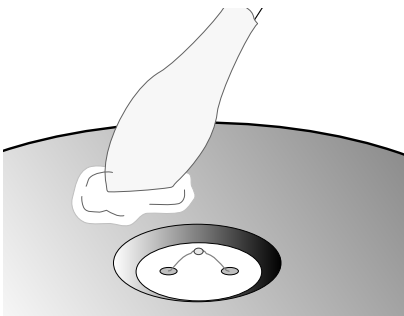
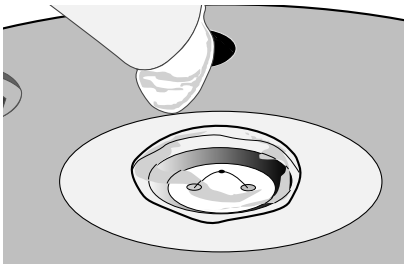

Place a waste container close by on the floor.

- 1 Use a cotton swab to remove residue from the surface of the mount surrounding the thermocouple.

CAUTION!

Do not contact the thermocouple with the swab.

- 2 With the dropper, release cleaning solution onto the thermocouple mount.
- 3 Immerse the thermocouple and the entire surface of the mount in cleaning solution. Let stand at least 1 minute.

4.3 *Cleaning the TC Head*

- 4 Hold the TC head over the waste container.

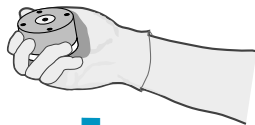

- 5 Quickly pull the TC head straight down and away from the droplet of liquid, allowing liquid to fall into the waste container directly below.

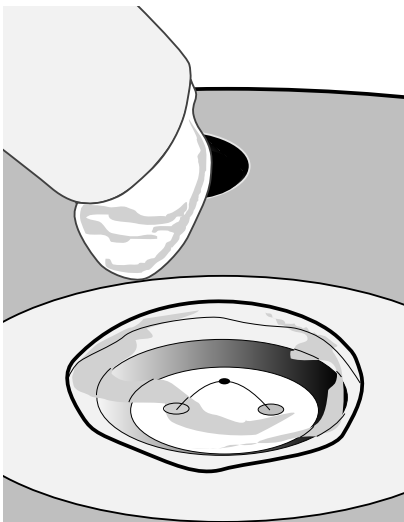

- 6 Immediately apply rinse water before evaporation can occur. Use purified water with resistivity of 1 Megohm/cm³ or higher for rinsing. **Water of lesser quality will contaminate the thermocouple.**

CAUTION!

Do not contaminate the rinse water by touching the tip of the water dropper (or the water drop) to the water standing on the mount .

- 7 Dilute any remaining droplets of cleaning solution with purified water.

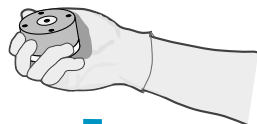

- 8 Repeat Steps 4, 5, and 6.

4.3 Cleaning the TC Head

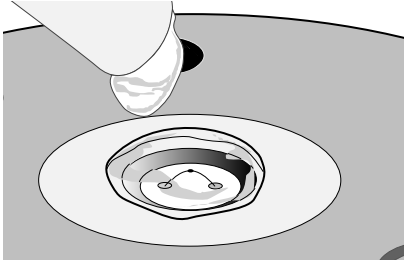

- 9 Repeat this procedure at least ten times, using enough water to cover the central depression and thermocouple.

CAUTION!

Shaking or tipping the can of Blow Clean will severely contaminate the thermocouple. The can must remain flat on the bench.

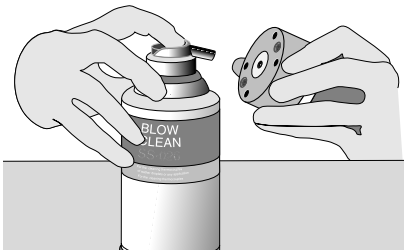

- 10 Place the Blow Clean upright and level on the bench. Clear the nozzle with a slight stream of gas. Hold the TC mount about 2 inches from the nozzle, then aim the nozzle directly at the thermocouple and release a slight stream of gas to blow away any remaining droplets.

- 11 Repeat Steps 1 through 10 using Wescor's Thermocouple Cleaning Solution with Anionic Detergent (SS-223).

- 12 Inspect the TC mount for any residual contamination. If foreign material cannot be removed using this procedure, refer to Section 4.6.

NOTE:

Some contamination is invisible, even under the microscope. Inspection can reveal many types of contamination, but cannot replace the Clean Test.

4.4 Reinstalling the TC Head

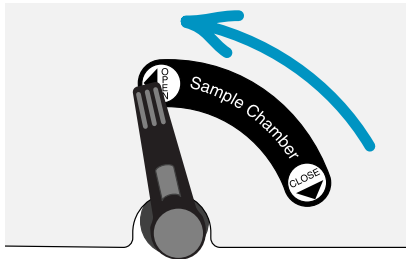

1 Verify that the sample chamber lever is in the open position.

2 Replace the TC head.

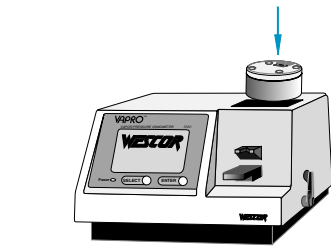

CAUTION!

The instrument will not hold calibration if the chamber screws are loose.

3 Start each screw into the threads, then tighten each screw progressively with the 9/64 inch hex driver, until all four are firmly tightened.

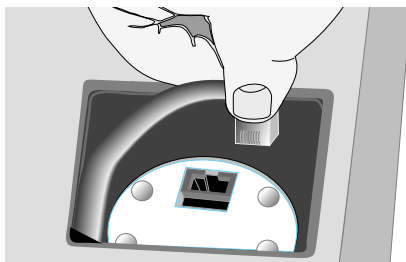
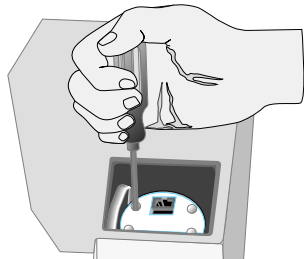

4 Reinstall the TC head connector.

4.4 *Reinstalling the TC Head*

- 5 Replace the access cover.
- 6 Close the sample chamber.
- 7 Turn on the power. Allow the instrument to complete the initialization sequence and reach thermal equilibrium (see Section 4.5) before attempting to calibrate the osmometer.
- 8 Calibrate using the 290, 1000, and then 100 mmol/kg standards. After calibrating using the 100 mmol/kg standard, select CLEAN TEST and then press ENTER.
- 9 If the Clean Test reveals contamination, refer to Section 4.6 and (if necessary) Section 5.1.

4.5 *Equilibration After Cleaning*

Cleaning the thermocouple mount changes the thermal equilibrium of the instrument and causes a temporary shift in calibration after the TC head is reinstalled. After reinstalling the thermocouple head, allow the instrument to regain thermal equilibrium.

The Temperature Drift indicator will be near center when the osmometer temperature is stable. See Section 2.3.

4.6 Severe or Stubborn Contamination

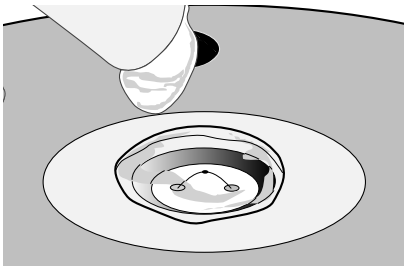

If the Clean Test indicates residual contamination in spite of a clean appearance:

- 1 Repeat the cleaning procedure. Calibrate the instrument using the 290, 1000, and 100 mmol/kg standards. Then run a second Clean Test. If there is significant improvement, contamination can likely be removed by repeated cleaning.
- 2 You can often successfully remove the contaminant simply by applying a droplet of purified water to the thermocouple and allowing it to stand for 30 to 60 minutes.

Causes of Unusual Contamination

While there are many potential causes of unusual contamination, the following are the most common:

- A severely contaminated thermocouple with visible accumulations of organic matter or salt deposits is evidence of incorrect or careless loading procedures.
- Careless loading of greasy or waxy specimens.
- Failure to clean fingerprints or other deposits from the sample holder.
- Oily residue from compressed air lines when an air jet is used to blow water droplets from the thermocouple after cleaning.
- Improper use of Blow Clean. Liquid discharged from the can onto the thermocouple mount leaves an oily deposit that is difficult to remove.

4.6 Severe or Stubborn Contamination

Removing Difficult Contamination

Many contaminants can be detected and removed under microscopic examination. If cleaning fails to produce an acceptable clean test, examine the thermocouple head under a microscope at 30X to 60X power.

Gross contamination can usually be removed by repeated cleaning, although mechanical scrubbing, as described below, may expedite the process.

NOTE:

Concentrated ammonium hydroxide (from local stores) can be used to remove stubborn contaminants, but it may not be effective on oily, greasy, or waxy materials. For these more difficult situations, try cleaning agents such as acetone or a laboratory detergent such as Wescor's Thermocouple Cleaning Solution with Anionic Detergent (SS-223) or Alconox.

To remove deposits:

- 1 Apply cleaning agents using the methods described in Section 4.3.
- 2 Cut a wooden swab stick on a sharp angle to form a fine point.
- 3 Scrub the surface of the mount with the swab stick and rinse.

Performed under the microscope, this procedure is unlikely to damage to the thermocouple itself. With patience, and repeated use of cleaning agents, even the most severely contaminated thermocouple can be cleaned.

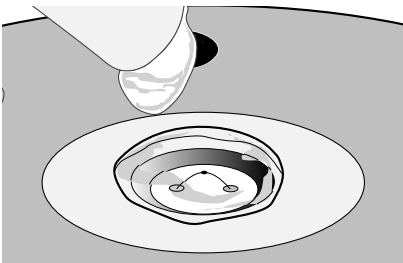
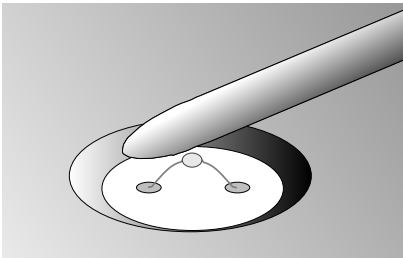
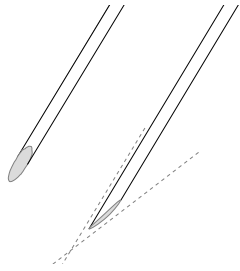

SECTION 4
PREVENTIVE MAINTENANCE

4.6 *Severe or Stubborn Contamination*

To clean dark or corroded copper connection points:

- 1** Apply a droplet of concentrated ammonium hydroxide (NH_4OH , 28 to 30%) or household lime remover to the TC mount. Soaking with this solution for a few minutes will reduce oxidation and restore the bright copper color.
- 2** Rinse the thermocouple with pure water.

5.1 *Troubleshooting*

This section describes problems you might encounter in using the Vapro osmometer, with suggested solutions. The first part is a flow chart to help you identify problems by symptom. Beginning with the apparent symptom, trace through the flow chart to identify possible causes and solutions for the difficulty. Each set of symptoms and solutions is repeated and discussed in greater detail in the following pages of Section 5.1. The solutions are indexed to more in-depth information throughout this manual.

The suggestions listed here are intended to help you quickly solve routine problems. For unusual problems which require more detailed information about the operation of the osmometer, refer to the Vapro Service Manual.

If you have tried all these suggestions and still need help, contact your dealer or Wescor for assistance. Refer to Customer Service, Section 1.2.

5.1 Troubleshooting

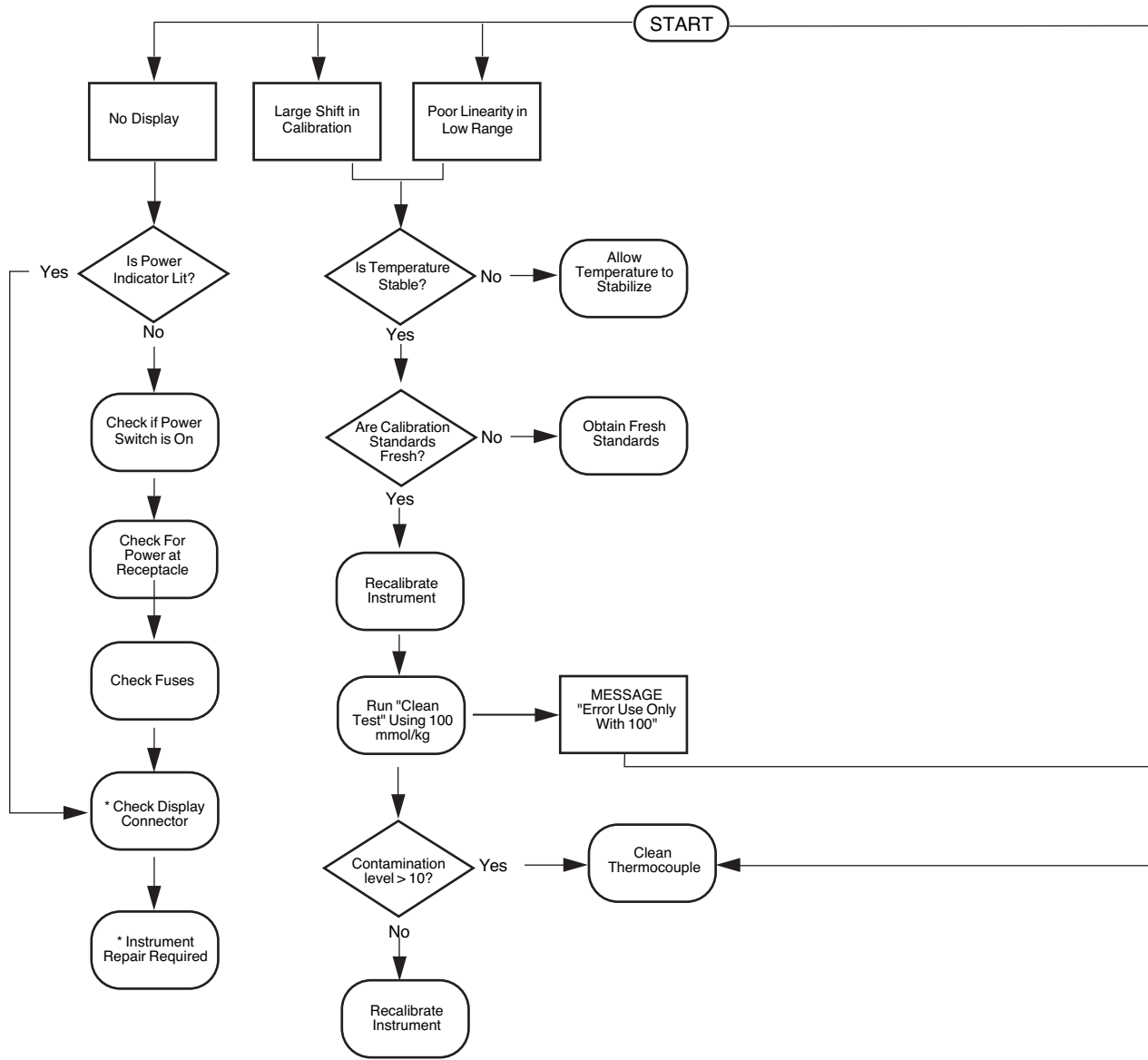

* Performed By Qualified Personnel Only

5.1 Troubleshooting

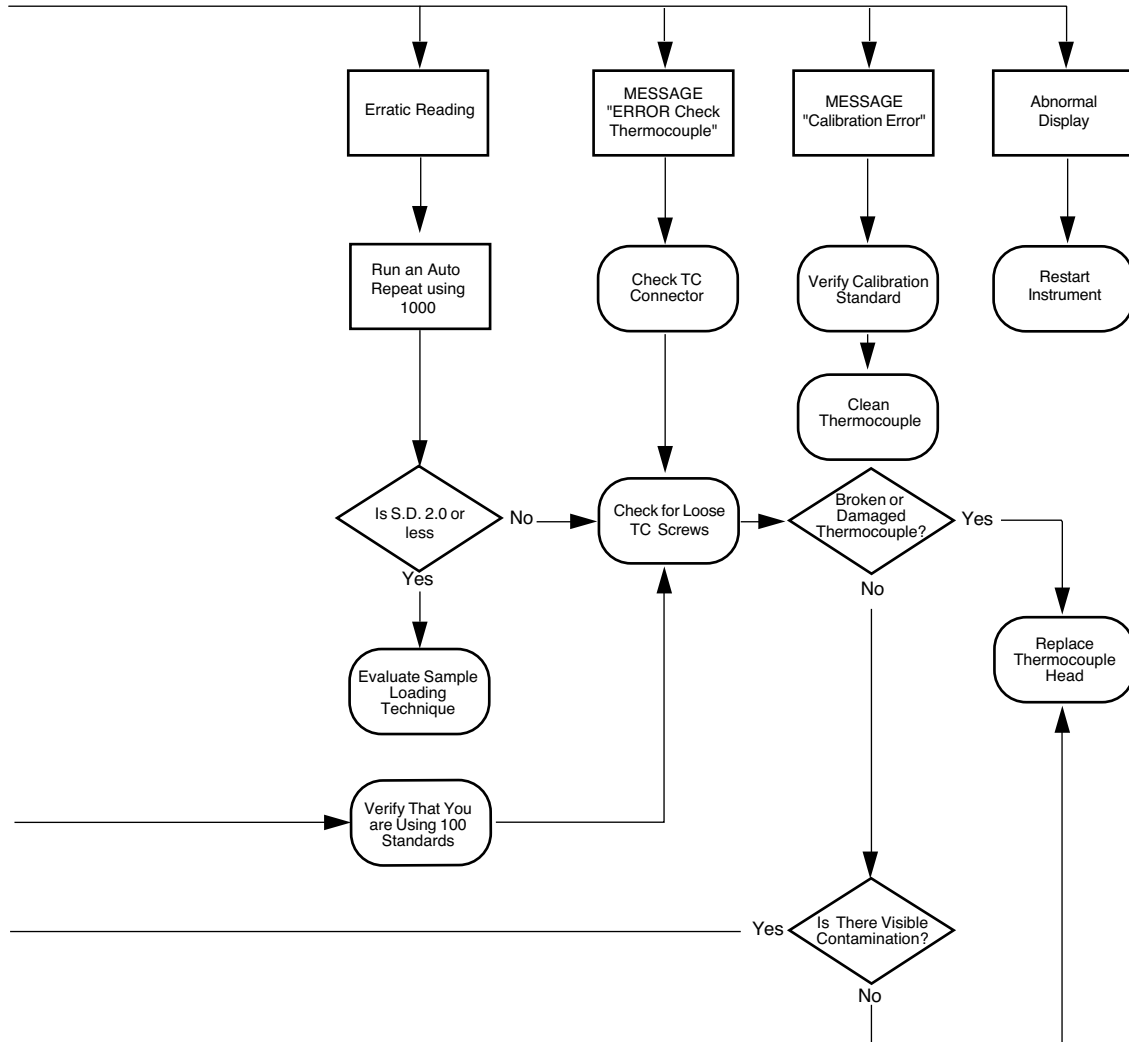

5.1 Troubleshooting

The following is a detailed presentation of material covered in the Troubleshooting Flowchart. This material is indexed to further information found throughout the manual.

Problem

Display is blank.

Solution

Check to see if power indicator is lit.

Check to see if power is on.

Check for power on mains.

Check fuses (see Sections 1.5 and 2.8).

Check the display and keyboard connections.

WARNING!

To avoid the risk of serious injury, the display and keyboard connections should only be checked by qualified service personnel.

Reset instrument by turning off power for 3 seconds. Then turn power back on.

If none of these steps resolves the problem, contact your dealer or Wescor for assistance.

There is a large shift in calibration.

Check the Temperature Drift Scale on the display. If the scale indicates that ambient temperature is outside acceptable levels, take steps to stabilize the instrument. See Section 2.

5.1 Troubleshooting

Problem

There is a large shift in calibration.

Solution

Check the freshness of the calibration standards and replace if needed. See Section 4.

Calibrate the instrument and then run the Clean Test. If the contamination level is greater than 10, clean the thermocouple. If the contamination level is less than 10, recalibrate the instrument.

There is poor linearity in the low range (below 200 mmol/kg).

Check the Temperature Drift Scale on the display to see if temperature is stable. If necessary, allow the instrument to stabilize. See Section 2.3.

Verify that you are using fresh calibration standards. See Section 4.

Calibrate the instrument and then run the Clean Test (Section 3.4) using the 100 mmol/kg standard. If contamination is greater than 10, clean the thermocouple using the instructions in Section 4.



If you run the Clean Test and the display shows "ERROR Use only with 100 mmol/kg standard," this may indicate that you incorrectly used a 290 mmol/kg or 1000 mmol/kg standard for the test. Run the Clean Test again using the 100 mmol/kg standard.

If while using the 100 mmol/kg standard you see "ERROR Use only with 100 mmol/kg standard" on the display, check for loose TC head screws.

5.1 Troubleshooting

Problem (Continued)

There is poor linearity in the low range (below 200 mmol/kg).

Scrambled or erratic reading on the display or poor repeatability.

The display shows:



Solution

If, after taking the above steps, the error message again appears after running the Clean Test, check the TC mount for gross (visible) contamination. A grossly contaminated TC mount requires extensive cleaning and may require replacement. See Sections 5.2, 5.3, and 5.4. If these procedures fail to resolve the problem, contact your dealer or Wescor for assistance (Section 1.2).

Run a 1000 mmol/kg standard in Auto Repeat Mode, then check the standard deviation shown on the display. If less than 2.0, assess your sample loading technique for possible loading errors. See Section 3.2.

If standard deviation is greater than 2.0, check for loose TC head screws. See Section 5.2. If this is not the problem, check the TC mount for gross contamination.

If these steps fail to resolve the problem, contact your dealer or Wescor for assistance.

Check the TC connector for incomplete contact. Check for loose TC head screws.

Remove the TC head and inspect the TC mount under a microscope for bent, damaged, or broken thermocouple. If thermocouple is undamaged, check for gross or visible contamination. If contamination is evident, clean the thermocouple according to instructions in Section 5.2, or replace the TC head. If these measures fail to work, contact your dealer or Wescor for assistance (Section 1.2).

5.1 Troubleshooting

Problem

Calibration deteriorates after cleaning the TC mount.

Solution

Check for deformed or broken thermocouple.

Abnormal display, or sample reading on an empty chamber, or one of following Error messages:

Reset instrument by turning the power off for at least 15 seconds, then turn power back on.

Be sure the sample holder is thoroughly clean and dry before closing the sample chamber (see Section 3.6).

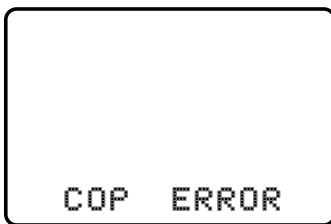

If this fails to resolve the problem, contact your dealer or Wescor for assistance.

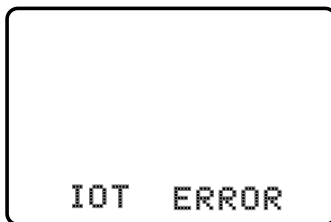

5.1 Troubleshooting

Problem

The following error message appears on the screen:

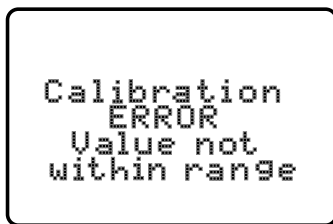

Solution

Be sure that you are using the correct calibration standard.

Check the TC head connector for faulty connection.

Clean the thermocouple.

Check for loose TC head screws. If these steps fail to solve the problem, contact your dealer or Wescor for assistance.

5.2 Common TC Head Problems

Many years of field experience have shown that the majority of problems encountered with the osmometer are with the thermocouple sensor. It is suspended from the thermocouple mount, which forms the upper half of the sample chamber. The thermocouple mount is part of the thermocouple head assembly, referred to simply as the "TC head."

Common thermocouple problems affect instrument performance in distinctive ways, providing significant clues that will be evident in the behavior of the instrument. These are summarized below in order of most likely occurrence.

COMMON TC HEAD PROBLEMS

<u>Problem</u>	<u>Symptom(s)</u>
Thermocouple Contamination	A shift in calibration. Error message during calibration or Clean Test.
Deformed or Flattened Thermocouple	Loss of high range readings or precision.
Broken Thermocouple	ERROR message on display or wildly erratic behavior if the connection is intermittent.
Disconnected TC Head Connector	ERROR message on the display.
Loose TC Head Screws	Unstable calibration and erratic readings. ERROR message during calibration or Clean Test.

5.2 Common TC Head Problems

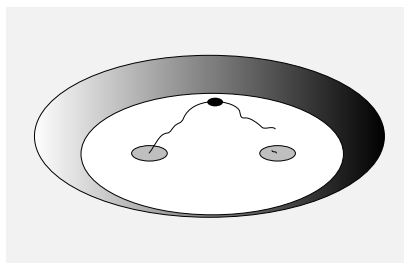
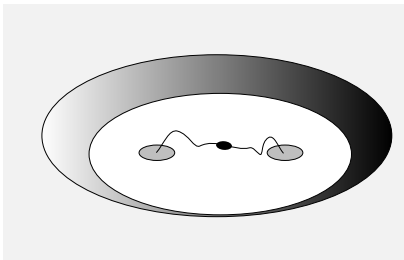
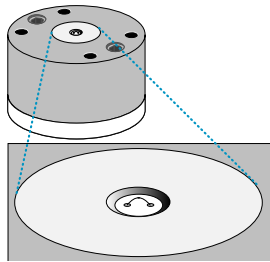

Problems can often be solved by inspecting and cleaning the TC head.

- 1 Follow the instructions in Section 4 to remove the TC head.

NOTE:

To improve temperature stability inside the osmometer, leave the access cover in place while the TC head is out of the instrument.

- 2 Carefully inspect the TC head under a microscope. Check for any gross contamination on the thermocouple or thermocouple mount.

Contamination is a natural consequence of normal use of the osmometer. It may also occur inadvertently during shipping or set-up. Contamination changes the linearity of the instrument response, first detectable in the lower ranges of osmolality.

Contamination does not generally degrade precision, but, depending upon the nature of the contaminating substance, this can occur. See Section 4 for complete instructions to detect and remove contamination.

NOTE:

Contamination can be invisible to the eye; even if the thermocouple appears to be clean, it may not give an acceptable Clean Test (Section 3.4). In this case, follow the instructions in Section 4.6.

- 3 Check if the thermocouple has been deformed or broken. Refer to Section 5.4 for information on identifying thermocouple deformation and how to restore it to normal shape.
- 4 Inspect the TC head connector and the mating pins for distortion or misalignment.

5.2 Common TC Head Problems

NOTE:

Always switch power off before connecting or disconnecting the TC head.

If the connector is damaged, electrical connection may be compromised or fail altogether. A failed connection produces an ERROR message on the display, as with a broken thermocouple. A poor connection can cause erratic performance.

If the source of difficulty is still unknown, at least the most frequently occurring problems will have been eliminated.

Testing Osmometer Performance

- 1 Reinstall the TC head to continue troubleshooting.
- 2 Set the instrument up using the procedure outlined in Section 3.
- 3 Allow 30 minutes for thermal equilibrium.
- 4 If you have a problem performing any of the steps of the setup procedure, a malfunctioning electronic module is likely. Contact Wescor or your dealer for assistance. Replacement parts are available for user installation, or the entire instrument can be returned to Wescor for repair. Loan instruments are available from Wescor if needed. Refer to Section 1.2.

5.3 *External Factors Affecting Precision*

Problems with instrument precision have a number of possible sources. Often, poor reproducibility is caused by external factors that are entirely independent of the instrument itself. The following are some of these factors:

- **Incorrect Use of Calibration Standards.**

Instrument accuracy, and linearity, depend upon the correct use of osmolality calibration standards. Refer to Section 2.5, 2.6 and Appendix E for further information.

- **Sampling Error**

Sampling error tends to be amplified when dealing with specimens of 10 microliters or less. You can prevent errors by using consistent technique and appropriate methods of transferring samples. See Section 3.2 for details.

- **Micropipettor-Caused Errors**

Unlike the maintenance-free micropipettor supplied by Wescor, many micropipetting devices require routine maintenance. Without proper maintenance, micropipetting devices can exhibit significant volumetric error (in excess of 50%) and cause corresponding variations in indicated osmolality. Positive displacement micropipettors are not recommended as an alternative to the Wescor micropipettor, except when dealing with samples of very high viscosity.

- **Poor Precision**

- 1 Determine whether the problem is with the instrument or is caused by external factors, such as the micropipettor.
- 2 Check the location of the osmometer for possible sources of thermal disturbance, as outlined in Section 2.3.

Use AUTO REPEAT to evaluate the precision of the osmometer.

Run the instrument with 1000 mmol/kg standard in AUTO REPEAT to determine if the instrument can repeat well. If it does, consider the possibility of loading errors causing poor repeatability.

5.4 Deformed or Broken Thermocouple

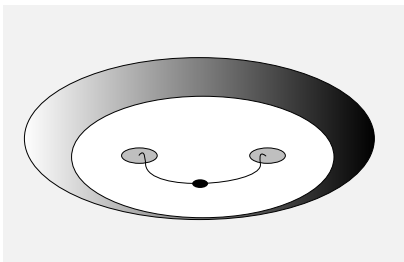
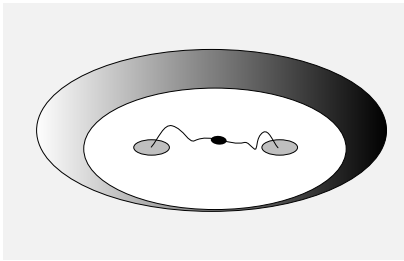

The thermocouple is well protected while the TC head is in the instrument. Cleaning procedures detailed in this manual should not harm the thermocouple, but it can be deformed or broken if contacted by any object while it is out of the instrument.

- If the thermocouple is only slightly deformed, the instrument will automatically adjust for the deformed thermocouple and function normally.
- A badly deformed thermocouple will still function but will show a noticeable loss of measurement precision.
- A deformed or flattened thermocouple with its bead lying close to or touching the surface of the mount will not cool to normal temperature depression during the measurement cycle (Appendix C). As a result, the instrument may display a meaningless value.

Restoring a Deformed Thermocouple

You can usually salvage even a severely deformed thermocouple by carefully lifting it into normal position. Although the thermocouple wires are only 0.025 mm in diameter, they are quite malleable and are generally amenable to straightening and reshaping.

In any event, you may as well make the attempt, since a badly deformed thermocouple will not function. Because of the delicate nature of the task, you will need steady hands and a microscope, preferably stereoscopic, having magnification in the range of 30X to 60X.

5.4 Deformed or Broken Thermocouple

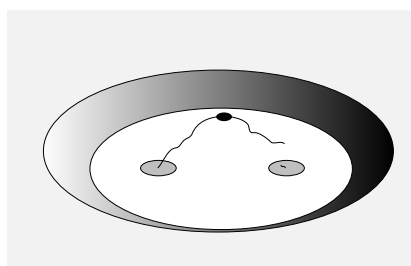
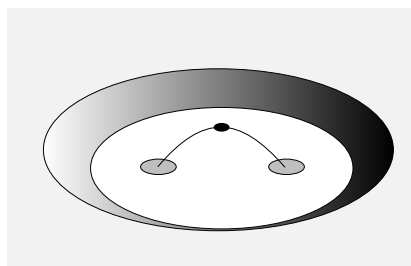
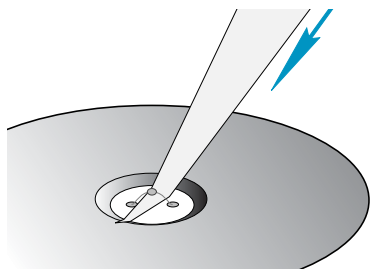

- 1 Make a tool by cutting a thin sliver or wedge from a sheet of ordinary paper.
- 2 Work the pointed end of the paper sliver under the thermocouple wire.
- 3 Use the paper sliver to lift and reshape the thermocouple. The paper sliver is sufficiently flexible to avoid undue stress on the thermocouple wires. Shape the thermocouple to a rounded arch that is perpendicular to the surface of the TC mount, as illustrated. The junction (bead) should be at the high point of the arc.
- 4 Thoroughly clean the thermocouple (Section 4) before reinstalling the TC head.

Broken Thermocouple

Usually, a broken thermocouple is readily evident, especially under a microscope. On rare occasions, the thermocouple may have an intermittent electrical connection that will cause highly erratic behavior in the osmometer. A break at either of the thermocouple connection points may require meticulous inspection to discover. A broken thermocouple requires replacement of the TC head. Contact your dealer or Wescor for assistance.

Instrument Specifications

Sample Volume	10 μ L nominal (Larger samples or samples as small as 2 μ L can be measured reliably with special procedures)
Measurement Range	Typically 0 to 3200 mmol/kg* @ 25 °C ambient
Measurement Time	80 seconds
Resolution	1 mmol/kg
Repeatability	Standard deviation \leq 2 mmol/kg
Linearity	2% of reading from 100 to 2000 mmol/kg
Readout	10 X 6.8 cm LCD
Operating Temperature	15° to 35 °C ambient Maximum relative humidity 80%(instrument should be at stable temperature before calibrating)
Calibration	Automatic using Opti-mole™ osmolality standards
Serial Output	RS-232 (ASCII format)
Electrical	
Line Voltage	100 to 120 V or 220 to 240 V nominal, (set at factory, user selectable with fuse change) 50 to 60 Hz
Power	Less than 5 watts
Fuses	1/8 ampere, 1/4" x 1-1/4" time-delay type for 100 to 120 volts (2 required) 1/16 ampere, 1/4" x 1-1/4" time-delay type for 220 to 240 volts (2 required)
Size	
Height	17 cm (6.6")
Width	29 cm (11.5")
Depth	34 cm (13.5")
Weight	3.6 kg (8 lbs)

*mmol/kg is the Standard International (SI) unit of osmolality. Refer to Appendix E.



Accessories, Supplies, and Replacement Parts

ACCESSORIES

AC-037 Micropipettor, 10 microliter
 AC-061 Ampule Organizer
 AC-066 Thermocouple Head Assembly, model 5520 0 to 3200 mmol/kg
 AC-067 Thermocouple Head Assembly, model 5520 above 3200 mmol/kg

AC-011 Hex Driver, 9/64 (screwdriver handle)
 AC-036 Forceps, 5-inch, stainless steel
 AC-049 Vapro Printer Cable

STANDARD SAMPLE HOLDERS (for solution osmolality)

AC-062 Sample Holder, 7 mm dia. x 1.25 mm deep (supplied with instrument)
 AC-063 Sample Holder, 4.25 mm dia. x 1.2 mm deep, (low sample volume)

SPECIAL PURPOSE SAMPLE HOLDERS (gross samples)

AC-064 Sample Holder, 7 mm dia. x 2.5 mm deep
 AC-065 Sample Holder, 9.5 mm dia. x 4.5 mm deep

OSMOMETRY STANDARDS/CONTROLS

OPTIMOL AMPULE STANDARDS, 0.4 mL vial (package of 60)

OA-010 Opti-Mole Osmolality Standard Solution, 100 mmol/kg
 OA-029 Opti-Mole Osmolality Standard Solution, 290 mmol/kg
 OA-100 Opti-Mole Osmolality Standard Solution, 1000 mmol/kg

OSMOLALITY CONTROLS

SS-039 Osmocoll HNL (High, Normal, and Low level) Osmolality Control References (package of 6, 1 mL vials, 2 High, 2 Normal, and 2 Low)

High: Approximately 330 mmol/kg (each Osmocoll lot has a specific osmolality)

Normal: Approximately 290 mmol/kg (each Osmocoll lot has a specific osmolality)

Low: Approximately 270 mmol/kg (each Osmocoll lot has a specific osmolality)

A P P E N D I X

B

Accessories, Supplies, and Replacement Parts

SUPPLIES

SS-003	Cleaning Solution, for manual cleaning (2 oz dropper bottle)
SS-006	Deionized Water (2 oz dropper bottle)
SS-223	Thermocouple Cleaning Solution with Anionic Detergent (60 mL dropper bottle)
SS-026	Blow Clean
SS-033	Sample Discs (vial of 5000)
SS-036	Micropipettor Disposable Tips for AC-037 (package of 1000)

REPLACEMENT PARTS

CIRCUIT MODULES and ASSEMBLIES

921136	Front Panel Keyboard Assembly
310300	Display Assembly
310354	Chamber Switch Assembly
330915-01	Power Supply Board Assembly
340531-01	Main Board Assembly
310346	Head Cable Assembly
RP-173	TC Head Exchange 0-3200 mmol/kg
RP-174	TC Head Extended Range (above 3200 mmol/kg)

FACTORY SERVICE

FS-255	Thermocouple Clean and Check Service
--------	--------------------------------------

MANUALS and INSTRUCTIONAL MATERIALS

M2468	5520 Vapro Osmometer User's Manual
M2469	5520 Vapro Osmometer Service Manual
V-1003	Thermocouple Cleaning Video, VHS Format (specify NTSC, PAL, or SECAM)

Theory of Operation

Osmolality is an expression of the total concentration of dissolved particles in a solution without regard for particle size, density, configuration, or electrical charge. Indirect means for the measurement of osmolality are afforded by the fact that the addition of solute particles to a solvent changes the free energy of the solvent molecules. This results in a modification of the cardinal properties of the solvent, i.e., vapor pressure, freezing point, and boiling point. Compared with pure solvent, the vapor pressure and freezing point of a solution are lowered, while its boiling point is elevated, provided that a single solvent is present in the solution. Solutions containing more than one solvent generally behave in more complex ways.

In single-solvent solutions, the relative changes in solution properties are linearly related to the number of particles added to the solvent, although not necessarily linearly related to the weight of solute, since solute molecules may dissociate into two or more ionic components. Since these properties all change linearly in proportion to the concentration of solute particles, they are known as "colligative" properties.

Osmotic pressure is also a colligative property of a solution, but unlike the other three, it is not a cardinal property of the solvent. Solution osmotic pressure can be measured directly using a semi-permeable membrane apparatus, but only with respect to those solute particles that are impermeable, since smaller solute particles freely transude the membrane and do not directly contribute to osmotic pressure. Such a measurement is referred to as "colloid osmotic pressure" or "oncotic pressure." It is expressed in terms of pressure, in mmHg or kPa. Total osmotic pressure, i.e., that which can be calculated on the basis of total solute concentration, is a theoretical concept only.

The measurement of total solution concentration, or osmolality, can only be made indirectly by comparing one of the solution colligative properties with the corresponding cardinal property of the pure solvent. The first practical laboratory instruments developed for routine measurement of osmolality were based upon depression of the freezing point and, until recent years, all osmometers for large-scale testing were based upon this methodology.

Theory of Operation

The Vapro osmometer embodies newer technology. It is based upon a measurement of vapor pressure depression made possible by thermocouple hygrometry. The vapor pressure method enjoys a significant intrinsic advantage over the measurement of either freezing point depression or boiling point elevation in that it can be performed without the necessity for a change in the physical state of the specimen. It is thus a passive technique of measurement that is free from measurement artifacts that often occur when the specimen to be tested must be altered physically. This fundamental difference in methodology gives rise to the many advantages of the vapor pressure osmometer over the older method.

In the Vapro vapor pressure osmometer, a 10 microliter sample of the solution to be tested is pipetted onto a small, solute-free paper disc which is then inserted into a sample chamber and sealed. A thermocouple hygrometer is incorporated integrally within the chamber. This sensitive temperature sensor operates on the basis of a unique thermal energy balancing principle to measure the dew point temperature depression within the chamber. This parameter, in itself a colligative property of the solution, is an explicit function of solution vapor pressure.

PROGRAM STEP 1, EQUILIBRATION AND ZERO SET

The sample is introduced into the chamber and the chamber is closed. Simultaneously, "In Process" and a countdown by seconds is displayed. (This remains until the end of sequence at Program Step 4.)

At this point, there will generally be some difference between the temperature of the specimen and the temperature of the sample chamber. Temperature equilibrium occurs within a few seconds. The vapor pressure may also reach equilibrium during this interval. The microvoltmeter reads the amplifier voltage to establish the reference for the measurement.

*Theory of Operation***PROGRAM STEP 2, COOLING**

An electrical current is passed through the thermocouple, cooling it by means of the Peltier Effect to a temperature below the dew point. Water condenses from the air in the chamber to form microscopic droplets upon the surface of the thermocouple.

PROGRAM STEP 3, DEW POINT CONVERGENCE

Electronic circuitry “pumps” thermal energy from the thermocouple via Peltier cooling in such a way as to cancel out heat influx to the thermocouple by conduction, convection, and radiation. Given this, the temperature of the thermocouple is controlled exclusively by the water condensing upon its surface. Thermocouple temperature, depressed below the dew point in Step 2, rises asymptotically toward the dew point as water continues to condense. When the temperature of the thermocouple reaches the dew point, condensation ceases, causing the thermocouple temperature to stabilize.

PROGRAM STEP 4, END OF SEQUENCE AND READOUT

The reading on the display is proportional to the vapor pressure of the solution. When this final reading is reached, a chime sounds and the “In Process” changes to “Osmolality.”

The result is displayed in SI units of osmolality—mmol/kg.

Theory of Operation

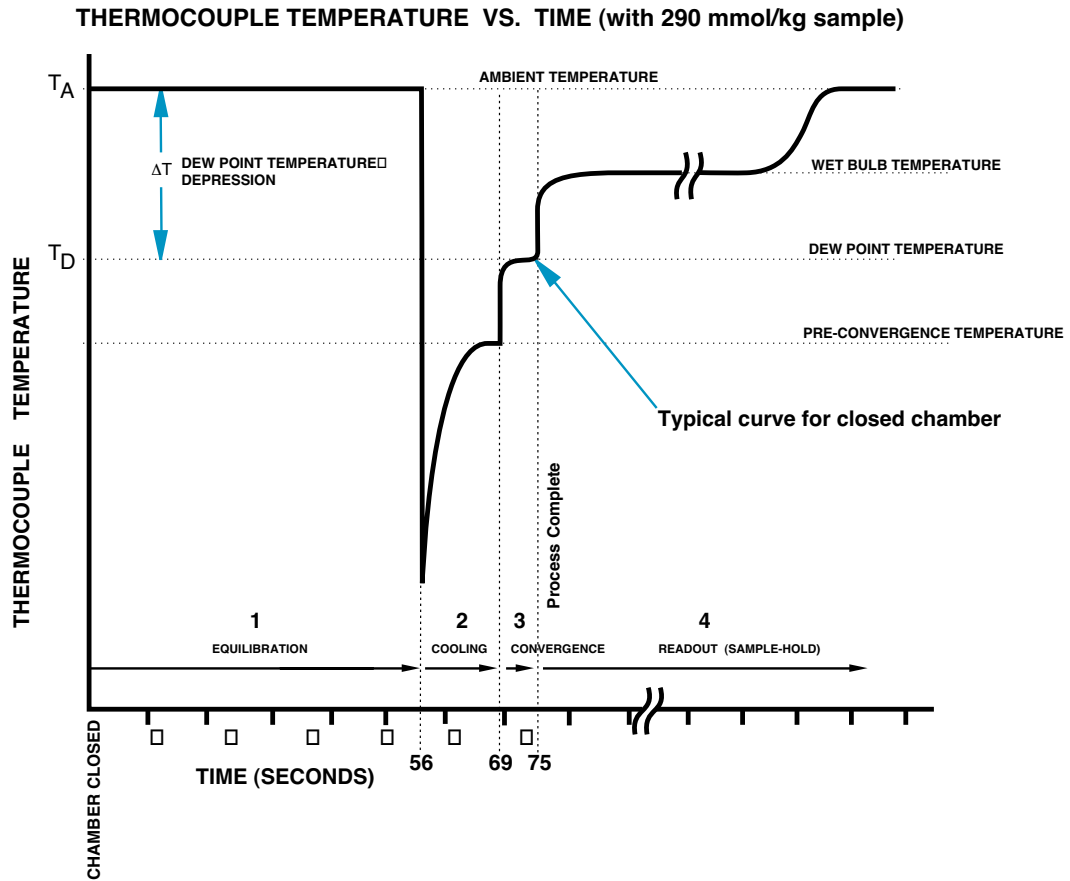

Theory of Operation

THERMOCOUPLE TEMPERATURE VERSUS OSMOLALITY

The graph on the left is a plot of thermocouple temperature versus time as the instrument cycles through the program, beginning with chamber closure (time = 0). The graph depicts the excursion of thermocouple temperature that typically occurs during each of the program steps outlined above. T_A is the ambient temperature in the chamber. T_D is the dew point temperature, and ΔT is the dew point temperature depression. The output is proportional to ΔT .

Assuming that the chamber remains closed while the osmometer displays the final reading at Step 4, the thermocouple temperature returns to T_A after holding at the wet bulb depression temperature until all of the water has evaporated from the thermocouple. If the chamber is opened, the water will evaporate almost instantly and the thermocouple temperature will quickly return to ambient.

The relationship between sample osmolality and the reading obtained by the osmometer is governed by fundamental considerations. Vapor pressure depression, a linear function of osmolality, has been identified as one of the colligative properties of a solution. The relationship between vapor pressure depression and dew point temperature depression is given by

$$\Delta T = \Delta e/S$$

where ΔT is the dew point temperature depression in degrees Celsius, Δe is the difference between saturation and chamber vapor pressure and S is the slope of the vapor pressure temperature function at ambient temperature. The Clausius-Clapeyron equation gives S as a function of temperature (T), saturation vapor pressure (e_0) and latent heat of vaporization (λ):

$$S = \frac{e_0 \lambda}{RT^2}$$

where R is the universal gas constant.

The dew point temperature depression, ΔT , is measured as a voltage signal from the thermocouple. This voltage is equal to ΔT multiplied by the thermocouple responsivity which is approximately 62 microvolts per degree Celsius. After voltage amplification by a pre-amplifier, the signal is processed by the microprocessor to provide calibrate and compensate functions and display the reading.

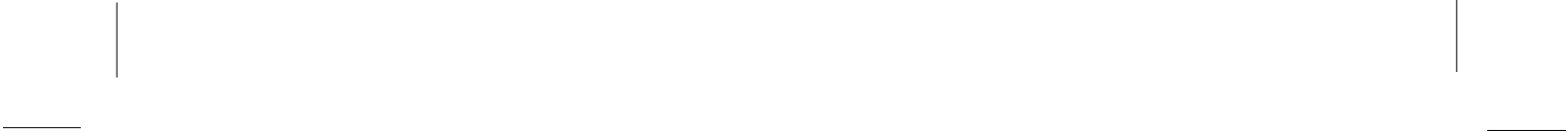

Special Application Notes

Clinical and General Research

The Vapro osmometer has unique advantages in many aspects of clinical chemistry due to its very small sample requirement. This is particularly true in pediatric practice. For example, the amount of sample collected for sweat, fecal, sputum, duodenal, and gastric analysis is frequently too small to allow osmolality assay by older macro methods, especially since other analytical parameters are very often simultaneously requested on such specimens.

An equally important advantage is that the vapor pressure osmometer does not physically change the sample. Where biological specimens or medications are multiphasic, or highly viscous, vapor pressure osmometry becomes the only reliable method of measurement. For example, feces, sputum, and gastrointestinal aspirate specimens usually contain variable amounts of mucous material that interferes with or prevents freezing point depression measurements but does not affect vapor pressure osmometry. Neither does the presence of finely suspended insoluble material, a feature of radio-opaque media, which are often examined to detect grossly high osmolality values likely to produce rapid dehydration when given to small infants.

In general research, the potential applications are too numerous to list. However, the vapor pressure osmometer is of value to a wide range of biologists and microbiologists concerned with fluid and electrolyte balance in all forms of life, especially where specimens are necessarily very limited in size, and may exhibit unusual viscosity.

The instrument is capable of vapor pressure determinations (expressed as osmolality) even on complex specimens such as tissue sections. Such specimens should be cut to approximately the diameter and thickness of the paper sample disc, if possible.

For experimental purposes, large-volume sample holders are available. These sample holders will accommodate gross specimens that are not amenable to testing with the standard shallow sample holder. Contact Wescor for more information.

Special Application Notes

PROCEDURE FOR VERY SMALL SAMPLES

You can measure samples with very low volumes (under 4 μL) using the following procedures.

Sample discs must be hand made from high-grade filter paper (Whatman #1 or equivalent) using a high-precision 1/8 inch diameter paper punch to produce discs with a very clean edge.

Required Equipment

- Wescor low-volume sample holder (AC-063)
- High quality round hole paper punch, 1/8" diameter (Mieth or equivalent)
- High quality 2 μL pipette, which will deliver precisely 2 microliters or less
- Pipette tips (short)
- Tweezers
- Teasing needle
- Whatman #1 Filter Paper or equivalent
- Lint-free tissue paper
- Cotton-tipped applicators

NOTE:

Maintain a stable ambient temperature. Heat, cold, air currents and temperature fluctuations which vary more than approximately 0.3° C within a 10 to 15 minute time frame, generally will result in poor quality data. You should monitor the Temp Drift Scale for ambient temperature fluctuations which will interfere with instrument accuracy.

Technique, including timing, is vitally important to obtaining good data while conducting very low volume tests.

Special Application Notes

SPECIAL LOW VOLUME PROCEDURE:

Preparing Paper Discs

- 1 Use a (Mieth or equivalent) 1/8 inch diameter punch to create a supply of paper discs. Punch only one thickness of paper stock at a time, to prevent paper discs from sticking together. That, along with static electricity will make it difficult to pick up a single disc with the tweezers.
- 2 After punching, remove paper discs from the retainer of the punch. Store discs in a clean, static-free container.

As stated before, very low volume tests require careful and consistent technique to achieve reliable results. The following are important for you to consider when running samples with very low volumes:

- Use only single sample discs. Because of their small size, you must be careful not to load more than one.
- Discs must be punched cleanly—no ragged edges.
- The sample holder must be kept very clean.
- Do not exceed 4 μL of sample in the special sample holder. Using too much sample fluid can severely contaminate the thermocouple.
- The paper disc must be completely saturated by sample fluid. If not fully saturated the disc may appear patchy. In this condition, data will be inconsistent and repeatability will be poor.

NOTE:

Very small samples of less than 2 microliters can be successfully measured using lighter paper for the discs. You should experiment with various papers. Be cautious that some papers contain electrolytes that make them unsuitable. Successful results have been achieved using standard laboratory lint-free tissue.

Special Application Notes

Instructions

Prior to running the 2 μL samples, calibrate the instrument using 10 μL samples at the 290, 1000, and 100 mmol/kg calibration set points.

- 1** Insert the 2 μL sample holder and calibrate on the 290 mmol/kg standard. If the osmolality of your samples are close to the 290 calibration set point it is not necessary to calibrate at the 1000 mmol/kg level,
- 2** Load a single paper disc into the center of the special sample holder. You may need to use the teasing needle and the tweezers to separate discs that are stuck together.
- 3** Place sample into the center of paper disc. Be sure to touch the pipette onto the disc as in regular procedure. Be sure the disc is completely saturated.
- 4** Close the sample chamber to begin the measurement cycle.
- 5** When the measurement is complete, open the sample chamber and retract the sample slide.
- 6** Thoroughly clean the sample holder of all sample material using lint-free tissue and a cotton-tipped applicator.

Special Application Notes

MEASURING LARGE SAMPLES

Measuring large samples requires consideration of the nature and size of the sample. You should experiment with these procedures to find the best approach for your particular application.

Samples such as leaf discs, tissues, and other solids often require considerable time to reach equilibrium. The Process Delay Mode allows you to delay the measurement indefinitely or to take successive readings without opening the chamber.

The time required to achieve equilibration can be determined by taking measurements until the readings no longer decrease. Once you become familiar with the required equilibration time for a particular type of sample, you can simply leave the chamber closed for the required time and then press ENTER to begin the osmolality measurement.

The standard sample holder has a diameter of 7 mm and a depth of 1.25 mm. Two optional sample holders are available from Wescor for measuring samples which are too large for the standard sample holder.

- AC-064 sample holder is 7 mm dia x 2.5 mm deep.
- AC-065 sample holder is 9.5 mm dia x 4.5 mm deep.

Special Application Notes

Instructions

- 1 For best precision, use the smallest holder that can accommodate the sample volume without danger of contaminating the thermocouple.

CAUTION!

Never load any sample that extends above the lip of the sample holder. Solid sample material extending above the lip of the sample holder can severely contaminate or even break the thermocouple.

- 2 Calibrate the instrument. Use the same size sample holder as will be used for the assayed sample. Match the volume and shape of the subject sample and the calibration solution as closely as possible. Several filter paper discs saturated with standard solution should be used for calibration to dampen the motion of the solution and to approximate the size and shape of the sample material.
- 3 Select Process Delay Mode. This allows you to delay the measurement cycle after closing the chamber until you press ENTER.
- 4 Place the sample in the sample holder. Push the sample holder into the chamber and close the chamber.

Solid (or some viscous) samples require extended periods to reach equilibration inside the chamber. On such samples you may want to make repeated measurements without opening the chamber to determine the time required to achieve equilibrium. Osmolality values will trend downward until they stabilize. If you know the required time, simply defer the measurement for that period.

Special Application Notes

- 5** Press ENTER to make a measurement. Osmolality is displayed when the measurement is complete.

- 6** For repeat measurements, leave the chamber closed and press ENTER. Readings should be lower with each successive assay until equilibrium is reached.

*Special Application Notes***SAMPLING VISCOUS AND/OR
NONHOMOGENEOUS SPECIMENS**

The broad range of specimen materials amenable to testing in the vapor pressure osmometer may require you to adapt your sampling technique to suit the physical characteristics of unusual samples. Using the micropipettor will assure the application of uniform volumes of both test specimen and calibrating solutions, but if the viscosity of the sample is extremely high, a positive-displacement micropipettor may be preferable for sampling. These devices are not recommended for routine use, however, due to their propensity toward carry-over error.

If the sample material does not readily saturate the paper sample disc or does not spread out over the whole disc naturally, it may be preferable to eliminate the sample disc and use the pipettor tip to apply the material as uniformly as possible over the central depression of the sample holder.

In other situations, materials can be sampled successfully by immersing the paper sample disc, which is held in the forceps, into the specimen to be tested, then carefully transferring the wet disc to the central depression of the sample holder. Caution must be exercised when using this "disc immersion" technique to avoid any contact of the wet sample disc with the outer portion of the sample holder, since this would result in solute material being transferred to the thermocouple mount and would rapidly contaminate the sample chamber.

In any event, when working with unusual specimens, make certain the sample occupies the full diameter of the central depression in the sample holder, as it would if saturated into a paper sample disc. The thickness of the specimen should be as small as possible.

*Special Application Notes***OSMOMETRY WITH MULTI-SOLVENT SOLUTIONS**

Biological solutions, in general, are aqueous in nature. Most specimens submitted to the clinical laboratory for testing, both pathologic and normal, will exhibit characteristic properties that are essentially attributable to the cardinal properties of water, as modified by the dissolved solute particles. Such solutions, which can be represented by a simple model, i.e., water as solvent with nonvolatile solutes, will have a linear, uniform relationship among all of the colligative properties (vapor pressure, freezing point, boiling point, etc.). In addition, most of these same solutions can be uniformly frozen with few artifacts arising from the freezing process. Thus, one can expect to obtain very similar results, if not exact duplication, between freezing point and vapor pressure measurements on the vast majority of clinical specimens.

Aside from this broad category of solutions, there is a small but important class of solutions that may be encountered in clinical work where the colligative relationships do not necessarily hold. These are solutions in which non-physiological volatile solutes—actually solvents—are present. In such cases, the interactions among the various molecules cause the properties of such solutions to be more complex. They generally do not follow linear relationships, as in solutions having only a single solvent. It must be remembered that osmometers for clinical applications, whether based on freezing point or vapor pressure methodology, determine the osmolality of solutions by indirect means. When complex solutions are encountered, the results obtained by either of these instruments may not faithfully represent the osmolality of the solution. Each instrument will respond to the parameter it is designed to measure, and the resultant indications must be interpreted accordingly.

Special Application Notes

You must be aware of this phenomenon if you are to correctly interpret results. By way of illustration, the table below depicts the results of solution osmolality measurements made by both vapor pressure and freezing point osmometers for varying amounts of ethanol in human blood serum. Note that in the vapor pressure instrument, concentrations of ethanol anywhere within the clinically significant range do not appreciably affect the indication of osmolality. This is because the vapor pressure of a water-ethanol solution does not change measurably with small concentrations of ethanol. On the other hand, the freezing point osmometer tends to overestimate the actual number of ethanol particles in the solution, as the freezing point falls disproportionately with increasing amounts of ethanol. Thus, neither instrument faithfully reports osmolality in the case of water-ethanol mixtures. In clinical practice, the unique response of the vapor pressure osmometer is usually an advantage inasmuch as it allows the clinician or attending physician to monitor the patient's serum metabolites (other than alcohol) independently of the patient's blood alcohol level.

TABLE
ETHANOL IN HUMAN BLOOD SERUM
VAPOR PRESSURE VERSUS FREEZING
POINT OSMOLALITY DETERMINATION

(1) Serum Osmolality (mmol/kg)	(2) Ethanol Added / kg (μ L)	(2) Ethanol (mg)	(2) Ethanol Added / kg (mmol)	Calculated Total Osmolality (mmol/kg)	Measured F.P. Osmolality (mmol/kg)	Measured V.P. Osmolality (mmol/kg)
289	2500	1953	42	331	340	287
289	5000	3905	85	374	392	285
289	10000	7810	170	459	501	282
289	25000	19525	424	713	798	277
289	50000	39050	849	1138	1400	250

(out of cal.)

(1) Instruments gave identical results on serum alone.

(2) Assuming 100% ethanol, with a relative gravity of 0.78.

Osmolality Standards

STANDARD INTERNATIONAL (SI) UNITS OF OSMOLALITY

Osmolality, by definition, is an expression of the total number of solute particles dissolved in one kilogram of solvent without regard for particle size, density, configuration, or electrical charge.

Traditionally, osmolality has been expressed as milliosmols per kilogram, with various abbreviations such as mOs/kg, mOsm/kg, and mOsmol/kg. The letters "Os" signify that osmolality is defined as the concentration, expressed on a molal basis, of the osmotically active particles in true solution. Thus, one mole (1000 mmol) of sodium chloride dissolved in a kilogram of water has an ideal osmolality of 2000 mOsm/kg, since a molecule of sodium chloride dissociates in solution to produce two ions, that is, two osmotically active particles.

In fact, a molal solution of sodium chloride has an osmolality value slightly less than the ideal because the residual mutual attraction of the hydrated ions reduces their mutual independence due to the osmotic coefficient. Since this coefficient varies with the solute concentration, the relation between osmolality and concentration of solute is not linear. For this reason, measurements of osmolality made on laboratory-diluted specimens, with subsequent multiplication by the dilution factor to calculate the original solution osmolality, will not give valid results.

Osmolality Standards

With complex solutions, such as biological fluids, analytical variables are universally expressed as the concentration of specific ions and of undissociated solute particles. It follows that a molal solution of NaCl can be analytically expressed as a combination of a molal solution of sodium ions and a molal solution of chloride ions. The total concentration of solute particles (the osmolality) is therefore 2000 millimolal. Osmolality can best be expressed simply as 2000 mmol/kg without the necessity of introducing the "osmole" concept.

The commission on Clinical Chemistry of the International Union of Pure and Applied Chemistry (IUPAC) and the International Federation of Clinical Chemistry (IFCC) have recommended that the unit of osmolality be mmol/kg, and this has been adopted by the American Journal Clinical Chemistry as part of its general acceptance of Standard International units. Wescor led the industry as the first osmometer manufacturer to adopt Standard International (SI) units for osmolality.

QUALITY ASSURANCE

Wescor calibration solutions are manufactured using reference data on the concentrative properties of sodium chloride in water from the Handbook of Physics and Chemistry, CRC Press. For quality assurance, each lot is compared by replicate osmolality measurements to reference solutions prepared from dried, high-purity sodium chloride obtained from the National Institute of Standards and Technology (NIST).

Wescor guarantees the accuracy of its calibration solutions within the combined overall accuracy of the reference solution formulations and the control measurements: 100 ± 2 mmol/kg; 290 ± 3 mmol/kg; $1,000 \pm 5$ mmol/kg.

Serial Data Output



The 5520 serial port uses a DB9 connector on the instrument back panel. This port is for asynchronous serial communication with a printer or computer. It uses standard non-return-to-zero (NRZ) format at RS-232 voltage levels.

The 5520 checks to see if the RTS (pin 7) is active. When a sample is assayed while a device is connected to the 5520's RS-232 port, the display status line will show:

```
ENTER to Send
```

To send data to the external device, press ENTER. The display will show:

```
Osmolality
```

SERIAL OUTPUT TECHNICAL DATA

Output voltage level:

Nominal ± 9 volts
Maximum ± 15 volts
Minimum ± 5 volts

Data protocol:

1200 bps
1 Start bit
8 Data bits
No parity
1 Stop bit

Serial Data Output

Pin Diagram:

Pin #	Mnemonic	Description
1	DCD	Data Carrier Detect (output)
2	RXD	Receive Data (output)
3	TXD	Transmit Data (input)
4	N/C	No Connection
5	GND	Signal Ground (passive)
6	DSR	Data Set Ready (output)
7	RTS	Request to Send (input)
8	CTS	Clear to Send (output)
9	N/C	No Connection

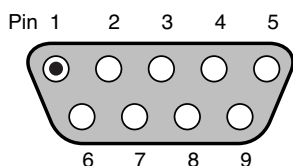

DSR is tied true whenever the instrument power is on. DCD and CTS are internally tied together.

The serial port is configured as Data Communications Equipment (DCE). This enables the osmometer to be connected directly to most computers and printers which are usually configured as Data Terminal Equipment (DTE). Use a STANDARD PC-AT type 9-pin to 25 pin serial cable. Do not use a null-modem cable unless your device is configured as DCE.

Data output is in ASCII characters. Upon power-up the osmometer will output the characters "READY" at the serial port. At the completion of a sample assay the instrument looks for RTS to be true. If this line is high, "ENTER to send" is displayed on the top line of the display. Press ENTER at this time to output the data on the serial port. The data format is as follows:

```

20 hex (space)
Reading
"mmol/kg"
OA hex (line feed)
OD hex (carriage return)

```

Setup Menu

The Setup Menu allows you to select available languages: English, French, or German and available measurement units: mmol/kg or kilopascals at 25 °C (= -2.5 x mmol/kg). It also allows you to run a Self Test on the instrument to check basic input and output functions.

Language and Units of Measurement are initially designated at the factory and stored in non-volatile memory. They become default settings on power up of the osmometer and are displayed briefly at that time.

To change these settings:

- 1 Turn off power. Wait approximately 10 seconds.
- 2 While pressing both the SELECT and ENTER keys, turn on the power. Wait several seconds while the display shows the Wescor logo, default selections, and finally the Setup Menu.
- 3 Select desired language or unit of measurement using the SELECT button to move the pointer to your choice. Press ENTER to add selection to memory.
- 4 Once you have selected your preferences you can exit the Setup Menu. The instrument defaults to these settings until they are changed.

Serial Data Output

Setup Instructions for the Seiko Serial Printer DPU-H245

- 1** Charge the printer batteries per manufacturer's instructions.
- 2** Turn the power ON while holding the FEED and CHARGE buttons down.
- 3** Using the FEED button for YES and the CHARGE button for NO, follow the prompts to change the printer settings as follows:

COMMAND MODE = MODE A

CHARACTER SET = GRAPHICS

SERIAL SETTINGS:

BIT LENGTH = 8BIT

PARITY = NON

FLOW CONTROL = RTS?CTS

BAUD RATE = 1200 bps

- 4** Connect the data cable from the Vapro to the printer.
- 5** The READY prompt and all measurement results will now be printed as they are displayed on the Vapro display.

A**Accessories** 73, 74**Accuracy**

- of standards 24, 25, 92
- of reported osmolality 25

Ambient Temperature 10, 43, 60, 82**Ammonium Hydroxide** 48, 55, 56**Ampule**

- organizer 18, 24
- standards (see Optimol)

ASCII Characters 94**Average Mode** 30, 42**Auto Repeat Mode** 31, 59, 62, 68**B****Blow Clean** 18, 50, 74**C****Calibrate Function** 32**Calibration**

- accuracy 25, 63
- adjusted to mean value 30
- effects of temperature changes on 21
- error 59, 64
- for maximum accuracy 42
- for very large samples 86
- for very small samples 84
- in Average Mode 30
- acceptable limits 42
- procedure 41, 42
- routine 42
- shift 38, 53, 58, 60, 61, 62
- standards 24, 42, 58, 61, 64, 68
- verifying 32, 33

Carry-over Error 88**Chime**

- signal 14, 37
- warning 20, 38

Claussius-Clapeyron Equation 79**Clean Test** 32, 34, 39, 40, 45, 50, 52, 54, 58, 61**Colligative properties** 9, 75, 89**Contamination** (see Thermocouple)**Customer Service** 8**D****Delete Result Function** 33**Dew Point Convergence** 77**Dew Point Temperature** 10**Dew Point Temperature Depression** 10, 79**Display**

- abnormal 63
- blank 60
- language 20, 95
- screen 12, 20, 37
- units 9, 37

E**Electronic Malfunction** 58, 60, 63, 67**ENTER Keypad** 12, 13**Equilibration** (see thermal equilibration)**Erratic Readings** 59, 70**Error Message(s)** 58, 59, 61, 63, 64**Ethanol in Human Blood Serum** 90**F****Facial Tissue** 18**Feces** 81**Filter Paper** 82, 85**Forceps** 18

Index

Function

- Calibrate 32, 33, 41, 42
- Clean Test 32, 40
- Delete Result 33
- Menu 29, 32, 42

Fuse(s) 16

- changing 28
- door 16, 28
- specifications, 28, 71

H

Hex Driver 18, 47

Human Blood Serum 90

Hygrometric Method 9

I

Initialization cycle 20

Inhomogeneities 9

In Process Display 37

Instrument

- dimensions 71
- front panel 13
- interior 15
- moving 21
- precision 65, 68, 71
- rear panel 16
- response characteristics 41
- right side 14, 15
- setup 17
- specifications 71
- weight 71

International Attention Symbol 7, 93

K

Keypad(s)

- ENTER** 12, 13
- SELECT** 12, 13

L

Language

- changing 95
- display 95

Linearity

- in low range 61, 62, 66

Line Voltage 71

M

Malfunction (see Electronic)

Measurement

- artifacts 9
- cycle 10, 31, 43
- errors 61-65
- position 19
- range 71
- reference point 10
- repeatability 71
- resolution 71
- sequence 76-78
- time 71, 86
- units 20, 101

Menu

- Function 29, 31
- Mode 29, 30, 42
- selection 29

Micropipetting

- technique 23, 35, 36
- errors 68

Micropipettor 18

- positive displacement 22, 88
- three-step 22
- two-step 22
- tip 10, 18, 22, 35, 36

Mode(s)

- Auto Repeat 31
- Average 30
- Menu 29
 - changing 29
 - selecting 29
- Normal 30
- Process Delay 31
- "Standby" 15, 21, 29, 38, 43

Multi-solvent Solutions

- measuring 89

N**Nonhomogeneous Samples 88****O****Opti-Mole Osmolality Standards 18, 24**

- evaporation 25
- opening 24

Osmocoll HNL Osmolality Control**Reference 26**

- control value 26
- refrigerating 26

Osmolality 75

- display 37
- on empty chamber 43
- range 71
- standards 18, 24, 25, 92

Osmometry

- boiling point 76, 77, 89
- freezing point 75, 77, 89, 90
- vapor pressure 75, 77, 89, 90

Osmotic pressure 75**P****Packing List 18****P****Paper punch 82****Paper Sample Disc(s) 10, 18, 35, 36, 39, 75**

- for special applications 82, 83, 84, 86
- measuring without 88

Pipette

- guide 12, 13, 36
- tip 10, 35
- special purpose 82

Particles

- solute 75

Power

- connecting 19, 60
- consumption 71
- cord 16
- indicator 12, 13, 20, 58, 60
- Entry Module 14, 16
- switch 16, 58
- Surge Protector 19

Preventive Maintenance 45**Process Delay Mode 31, 85****Properties**

- cardinal 75

Protection Sleeve 24**R****Radio-opaque media 81****Replacement Parts 74****Reproducibility 68, 71****RS-232 15, 93, 94****S****Sample(s)**

- Chamber 10, 12
- lever 14, 35, 37

Index

S

Sample(s)

- complex 31, 81, 89
- holder 10, 12, 35, 36
 - cleaning 39, 45, 84
 - special purpose 81, 82
- leaf disc, 85
- loading 34, 35, 82, 84
- mutiphasic 81
- nonhomogeneous 88
- physical characteristics 9, 81, 89
- slide 12, 13, 19
- solid(s) 85
- tissue 81, 85
- very small 82
- very large 85
- viscosity 9, 81
- volume 23, 71
 - large 85-87
 - very small 83-84
- variations in 34

Sampling Error 68

Screen (see display screen)

SELECT Keypad 12, 13

Sensing Element 10

Serial Data

- output 44, 93, 94
- pin diagram 94
- Port 14, 15, 44, 93, 94
- voltage data 93

Signal Chime 14

- shutter wheel 15

Software

- resident version 20

Solute Particles 9

Solution

- colligative properties of 9, 76
- concentration 9, 75
 - (see also "osmolality")

Special Applications 81-90

- Clinical and General Research 81

Specimen

- feces 81
- gastrointestinal aspirate 81
- physical state 9
- removing 38
- sputum 81
- sweat 81

Standard Deviation 30, 62, 71

Standard International Units 9, 38, 71, 77, 91

Supplies 73, 74

Swab Stick 55

T

Teasing needle 82

Temperature

- ambient 10, 20, 21, 43, 71
- considerations during setup 19
- dew point 10
- Drift Scale 20, 21, 53, 60, 61, 82
- stability 19, 71, 82

Thermal Equilibration 20, 21, 52, 53, 60, 67, 76, 85

Theory of Operation 75-79

Thermocouple (TC)

- cleaning 45-50, 55, 56
- Clean Test 40
- cooling 77
- control circuitry 43
- contamination 18, 34, 45, 48, 54-56, 58, 61, 62, 65, 66
- damage 55, 59, 62, 63, 65, 66, 70
- deformed 62, 63, 65, 66, 69
 - restoring 69, 70
- junction (bead) 70

Thermocouple (TC)

head

- cleaning 48-50, 55, 66
- cleaning supplies 18, 48
- connector 15, 46, 51, 65-67
- inspecting 66
- oxidation 56
- removing 45, 46, 47
- reinstalling, 51, 67
- screws 59, 61, 62, 64, 65

hygrometer 10, 76

hygrometry 76

mount 10, 65, 70

sensor 65

temperature graph 78, 79

Tissue Paper 82**Troubleshooting Flow Chart** 58, 59**U****Unit of Measure** 20, 91**User's Manual** 7, 18**V****Vapor Equilibration** 31**Vapor Pressure**

determination 9

equilibration 10

method 9

Viscosity

sample 9, 81

Voltage 71**Voltage Selector** 16, 27

changing 27

Volumetric error 68, 88