

METTLER TOLEDO

Operating instructions
METTLER TOLEDO
Spider 1S Scales

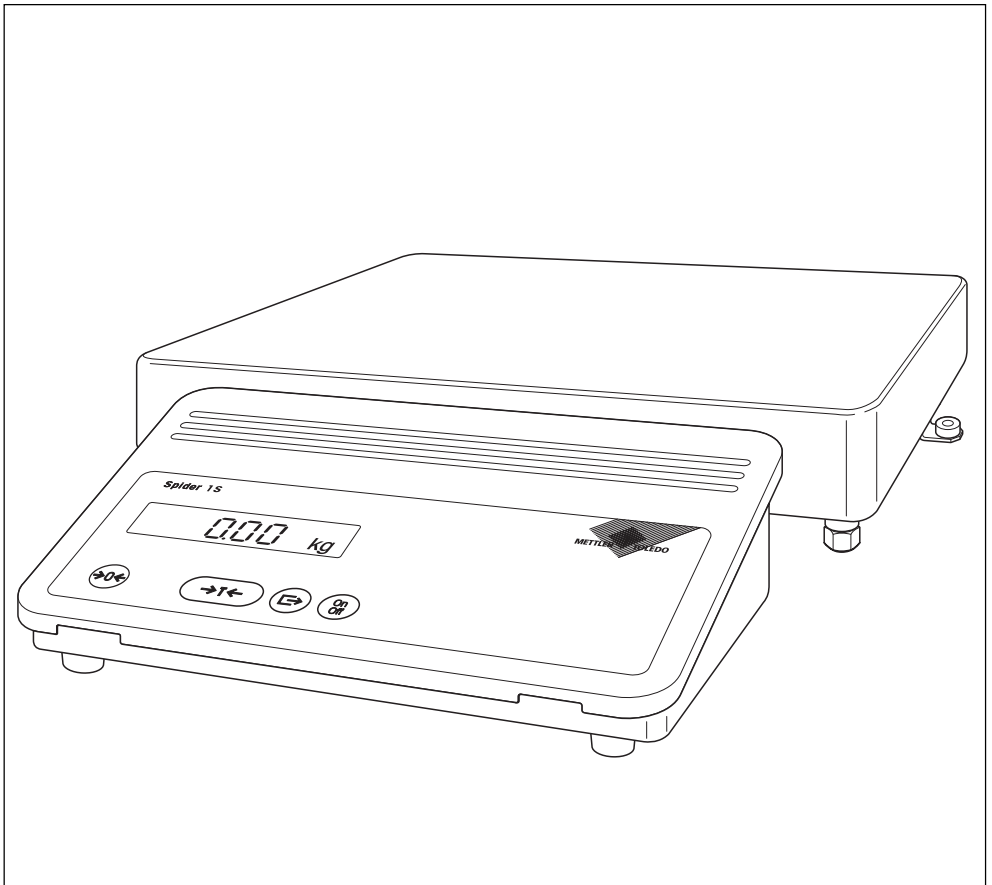

Display, controls and connections of your scale

Overview

No.	Designation
1	Weighing pan
2	Level (with certified scales only)
3	Weighing platform
4	Leveling foot
5	Terminal
6	On/off key
7	Transfer key
8	Tare key
9	Zeroing key
10	Display (see also expanded view)
11	Model designation

Connections (rear of terminal)

No.	Designation
18	Connection cable terminal-platform
19	Power cable
20	Serial interface RS232C
21	Free outputs for options

Please see section 7.1 for specifications of the power supply, the platform supply and the RS232C interface.

Display

No.	Designation
12	Display for special functions
13	Weighing units (kg, g, lb, t)
14	Alphanumeric display
15	Symbol for discharged battery (option)
16	Stability detector
17	Special symbol

Contents

1.	Getting to know your Spider S scale	6
1.1	Introduction	6
1.2	Overview of the Spider 1S scales	6
1.3	A wide range of optional equipment	6
1.4	What you should know about these instructions	7
1.5	Safety has priority	7
1.6	Declaration of conformity and safety tests	8
2.	Putting the scale into operation	10
2.1	For those in a great hurry	10
2.2	Unpacking and checking the standard equipment	11
2.3	Selecting or changing the location	11
2.4	Leveling the scale	12
2.5	Power supply	13
3.	Weighing made simple	14
3.1	Switching the scale on and off	14
3.2	Switching the display illumination on and off	14
3.3	Zeroing the scale	15
3.4	Taring the scale	15
3.5	Performing a simple weighing	16
3.6	Printing out the weighing result and transferring data	16
4.	The master mode	17
4.1	What is the master mode?	17
4.2	Operation in the master mode	18
4.3	Selecting the weighing unit	21
4.4	Selecting the resolution of the weighing result	21
4.5	Switching the automatic zero correction on or off	21
4.6	Activating or deactivating the automatic shutdown	22
4.7	Switching the automatic backup on or off	22
4.8	Setting the vibration adapter	22

4.9	Setting the process adapter	23
4.10	Configuring interface 1	23
4.11	Configuring interface 2 (optional equipment)	24
4.12	Increasing the display accuracy (for test purposes)	25
4.13	Printing out the settings	25
4.14	Resetting the settings to the factory settings	26
5.	Special applications and functions	27
5.1	Weighing in with manual taring	27
5.2	Weighing out of a container	28
6.	Further important information regarding your scale	29
6.1	When faults appear	29
6.2	Notes on caring for your scale	30
6.3	Notes on the interface	31
6.4	Overview of the master mode	32
7.	Technical data	33
7.1	General data and standard equipment of the Spider 1S scales	33
7.2	Data for individual models	34

1. Getting to know your Spider S scale

This section provides you with detailed information on your Spider S scale. Please read this section through carefully even if you already have experience with METTLER TOLL60 balances and scales and be sure to familiarize yourself with the safety instructions!

1.1 Introduction

Thank you for deciding to purchase a scale from METTLER TOLEDO.

The industrial scales of the Spider S line combine a wide range of weighing functions and setting possibilities with exceptional ease of operation and ruggedness. The weighing platform and the terminal have IP67 degree of protection. The Spider S scales are thus eminently suitable for use in production environments which necessitate frequent cleaning using a water jet (e.g. in the chemical industry and in food production). Further, the comprehensive sealing of the entire scale ensures hygienically perfect conditions as the ingress of foreign substances is virtually completely impossible. The integral interface ensures problem-free data interchange with numerous peripherals and thanks to the easily surveyed and attractively styled terminal your Spider S scale looks well in any environment. Please read through these operating instructions very carefully so that you can exploit all the possibilities offered by your scale to the full.

1.2 Overview of the Spider 1S scales

Different models of the Spider 1S scale are available. All scales have the same terminal, but differ in their weighing range and the size of the weighing platform. All Spider 1S scales have the following equipment features in common:

- Compact and rugged, industrial construction with a housing made of stainless steel. All materials used are resistant to moisture, resistant to most chemicals and suitable for use in the food industry. The weighing platform and the terminal meet the requirements of IP67 degree of protection.
- Built-in RS232C serial interface.
- Convenient keypad and large size, illuminated display.
- Universal expandability through an extensive range of optional equipment.

Your Spider scale has a CE declaration of conformity (see section 1.6) and METTLER TOLEDO as the manufacturer has been awarded ISO 9001/EN 29001 certification. Certified versions of Spider scales are also available, please ask your METTLER TOLEDO dealer.

1.3 A wide range of optional equipment

The wide range of optional equipment expands the application possibilities of your Spider S scale. For inquiries or orders, your local METTLER TOLEDO dealer will be pleased to help you.

1.4 What you should know about these instructions

These instructions contain orientation aids which facilitate your search for the desired information:

- Work steps are marked by “•”, whereas enumerations are preceded by a “–”.
- Key designations are enclosed in double angle brackets (e.g. «**On/Off**» or «**↔**»).
- Some keys of your Spider S scale have two assignments, i.e. two different functions can be called up with a single key, depending on whether the key is pressed briefly or pressed and held:



- This symbol indicates a brief keystroke.



- This symbol indicates a long, sustained keystroke (approximately 5 seconds).

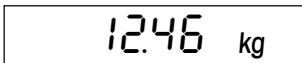

- This representation symbolizes the current display of your scale.



- These symbols indicate safety and hazard instructions. If these are not complied with, personal injuries to the user, damage to the scale or other tangible assets or malfunctions could result.

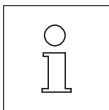

- This symbol indicates additional information and instructions which facilitate your handling of the scale and contribute to proper and economical use.

1.5 Safety has priority

Please note the following instructions for safe and problem-free operation of your Spider S scale.

- Read through these operating instructions carefully, even if you are already familiar with METTLER TOLEDO balances and scales.
- It is essential to note the instructions in section 2 when putting your new scale into operation.



- The Spider S scales must not be operated in a hazardous environment.



- **It is essential you note and comply with the cleaning instructions for your scale (section 6). The water tightness of your scale is assured only if the correct cleaning procedure is followed. This is a prerequisite for protection of the terminal and weighing platform to IP76 requirements!**

- Ensure that the voltage value printed on the model plate of your Spider S scale matches the local line voltage.

- Use only optional equipment and peripherals supplied by METTLER TOLEDO with your Spider S scale, these have been optimally matched to your scale.

- Your Spider S scale has a rugged construction, but it is still a **precision instrument** – treat it with the appropriate care and it will thank you with years of trouble-free operation.



- **Open neither the terminal nor the weighing cell**, they contain no parts which can be maintained, repaired or replaced by the user. Should the terminal or the weighing cell be opened, the warranty becomes null and void. Do not attempt to clean the interior of the weighing platform with solid objects. In the unlikely event you should experience problems with your scale, please contact your responsible METTLER TOLEDO dealer.

1.6 Declaration of conformity and safety tests

We, as manufacturer with sole responsibility, attest that the product to which this declaration relates is in conformity with the EC Directives stated below.

Notes: An EC type examination certificate has been obtained for certified scales and those subject to compulsory verification. The year of the first calibration is given next to the CE mark. Scales of this type are factory-certified and bear the designation «M» on the instrument itself and on its packaging. If the M is on a plain background, the scale may be put into service immediately. If the background is divided and hatched, the scale must be calibrated locally at its place of use by a certified METTLER TOLEDO Service facility. If the validity of the calibration is for a period limited by the country's national regulations, the operator of a scale of this type has sole responsibility for ensuring repeat certification in good time.

Scales and Terminals Spider 1S

Mark	EC Directive	Compliant with standard
	73/23EEC Low Voltage	EN61010-1:1993 EN61010-1/A2:1995 (Safety requirements)
	89/336EEC EMC	EN55011:1991 Radio interferences EN50082-1:1992 Immunity
	90/384EEC ¹⁾ Not automatic scales	EN45501:1992 ¹⁾ Not automatic scales

¹⁾ Applies only to certified scales (approval/test certificate no. T2867/TC2518)

Mettler-Toledo GmbH
Industrial BA IND-N
Nänikon, September 1996

Johannes Schmid
Manager
Business Area Industrial

Stephan Hermanns
Manager
Product Area Precision Scales

The scales and terminals of the Spider 1S range have been examined by accredited testing agencies. They have passed the **safety tests** listed below and carry the corresponding marks of conformity. The production is subject to process inspection by the testing authorities.

Country	Mark of conformity	Standard
Germany		EN61010-1:1993 EN61010-1/A2:1995 EN50082-1:1992 EN55011:1991

USA/Canada

This equipment has been tested and found to comply with the limits for a Class A digital device, pursuant to both Part 15 of the FCC Rules and the radio interference regulations of the Canadian Department of Communications. These limits are designed to provide reasonable protection against harmful interference when the equipment is operated in a commercial environment. This equipment generates, uses and can radiate radio frequency energy and, if not installed and used in accordance with the instruction manual, may cause harmful interference to radio communications. Operation of this equipment in a residential area is likely to cause harmful interference, in which case the user will be required to correct the interference at his own expense.

Cet appareil a été testé et s'est avéré conforme aux limites prévues pour les appareils numériques de classe A et à la partie 15 des règlements FCC et à la réglementation des radio-Interférences du Canadian Department of communications. Ces limites sont destinées à fournir une protection adéquate contre les interférences néfastes lorsque l'appareil est utilisé dans un environnement commercial. Cet appareil génère, utilise et peut radier une énergie à fréquence radioélectrique; il est en outre susceptible d'engendrer des interférences avec les communications radio, s'il n'est pas installé et utilisé conformément aux instructions du mode d'emploi. L'utilisation de cet appareil dans les zones résidentielles peut causer des interférences néfastes, auquel cas l'exploitant sera amené à prendre les dispositions utiles pour pallier aux interférences à ses propres frais.

2. Putting the scale into operation

In this section you will learn how you unpack and set up your new scale and prepare it for operation. On completion of the steps described in this section, your scale is ready for operation.

2.1 For those in a great hurry

If you are already familiar with the Spider S scales, the following short-form instructions comprising 5 steps will suffice for putting your new scale into operation. All other users are advised to study the following sections, which describe the individual steps in detail.

Nothing could be simpler!

1

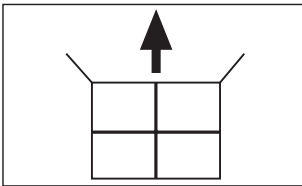

- Unpack

2

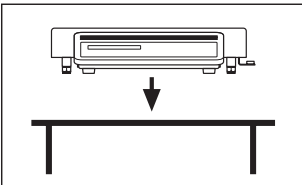

- Set up

3

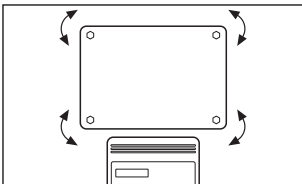

- Level

4

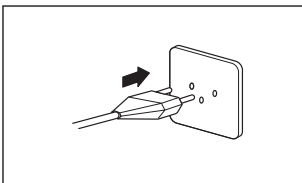

- Connect to power supply:
First check whether the voltage printed on the model plate of the scale matches your local line voltage. **If this is not the case, on no account connect the scale to the power supply,** but contact your METTLER TOLEDO dealer!

5

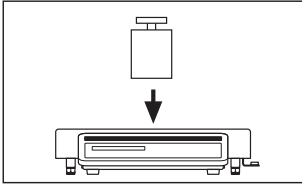

- Weigh!

2.2 Unpacking and checking the standard equipment

Before you set up your new scale and put it into operation, you should check whether you have received all accessories that are part of the standard equipment of your scale.

- Open the packaging carton and pull the scale together with the protective cushioning out of the carton. Remove the protective cushioning.
- Check the delivery for completeness. The following parts are included in the standard equipment:
 - Terminal and weighing platform with mounted weighing pan and level (with certified scales only)
 - Operating instructions
 - Open-end wrench to level the scale
- Store all parts of the packaging. This packaging guarantees the best possible protection for the transport of your scale.
- Check the scale for any damage. Notify your METTLER TOLEDO dealer immediately if you have any complaints. On no account put the scale into operation if you discover any external damage!



2.3 Selecting or changing the location

For your own safety, heed the following instructions regarding selection of the location. Also bear in mind that your scale is a precision instrument and will thank you for an optimum location with high accuracy and dependability.



- Never operate scale in a hazardous environment.

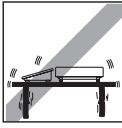

- Firm, vibration-free position as horizontal as possible. The foundation must be capable of safely supporting the weight of the fully loaded scale.



- Temperature range from -10 °C to +40 °C

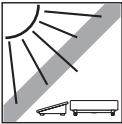

- No direct sunlight

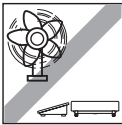

- No excessive drafts (e.g. from fans)

Note: If you have a **certified scale** and move this to a location far removed from the original site, please contact the local METTLER TOLEDO dealer at the new destination to have the scale recalibrated.

2.4 Leveling the scale

To compensate any minor unevenness at its location, the scale can be leveled:

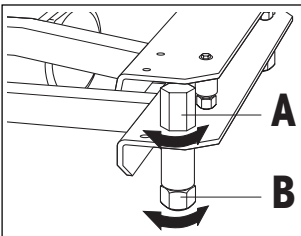

- Lift off the weighing pan. Loosen the lock nuts ("A") of the leveling feet (if necessary, use the open-end wrench supplied). Turn the adjustable feet ("B") until the scale is level, or ...

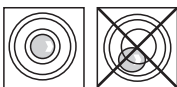

... the air bubble is located in the center of the level (only certified scales have a level).

- To prevent unintentional alteration of the leveling feet, tighten the lock nuts of all leveling feet using the open-end wrench supplied and then replace the weighing pan. **You should relevel the scale after every location change.**

2.5 Power supply

On delivery, the scale is set to the line voltage of the country of destination.



- First check whether the voltage printed on the model plate of the scale matches the local line voltage. **If this is not the case, on no account connect the scale to the power supply**, but contact your METTLER TOLEDO dealer.

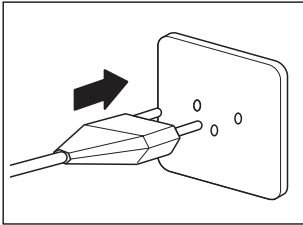

- Connect the scale terminal to the power supply.



Route the power cable so that it does not touch the weighing pan and such that it can never hinder your daily operations nor be damaged!

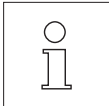

After connection to the power supply, the scale performs a self-test in which all display segments light up briefly. In addition, information specific to the scale is displayed briefly (software version etc.). This information is displayed each time the scale has been disconnected from the power supply and then reconnected. **We advise you to disconnect the scale from the power supply if it will not be used for a lengthy period.**

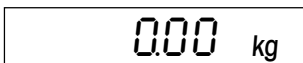

On completion of the self-test, your scale is ready for operation.

3. Weighing made simple

This section explains how you switch the scale on and off, set it to zero and tare it and how you perform a weighing. You will also learn how to print out the weighing result and transfer data.

3.1 Switching the scale on and off

After the scale has been put into operation for the first time we advise you not to disconnect it from the power supply (except during lengthy breaks in operation) – it is then in thermal equilibrium and ready for operation quicker.



- To **switch the scale on**, press the «**On/Off**» key briefly.
The scale performs a self-test.

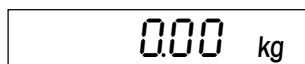

As soon as the weight display appears, your scale is ready for weighing.



- To **switch the scale off**, press the «**On/Off**» key again.

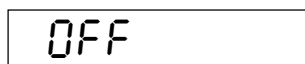

Switching off is confirmed briefly in the display with "OFF" and then the display is cleared.

3.2 Switching the display illumination on and off

For convenient work, the display of your scale is illuminated to allow perfect reading even under adverse lighting conditions.

The display illumination can be switched on and off at a keystroke:



- Press and hold the «**On/Off**» key until the illumination is switched on or off.

3.3 Zeroing the scale

As a result of environmental influences, your scale may not show exactly "0.00" even though the weighing pan is unloaded. However, you can reset the display of your scale to zero at any time to ensure that the weighing really starts at zero. Zeroing with a loaded weight is possible only within a certain range, which depends on the scale model. If the scale can not be reset to zero when a weight is loaded, this range has been exceeded.

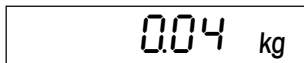

The scale does not show exactly zero even though the weighing pan is unloaded.



- Press the «→0←» key and the scale starts the reset to zero.



During the resetting, the horizontal segments appear in the display and after a short wait time ...

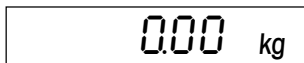

... your scale is reset to zero.

Note: If an error message appears during resetting, please consult the list of error messages in section 7.

3.4 Taring the scale

The weight of any weighing container can be "tared" at a keystroke so that the **net weight of the weighing sample** is always shown in subsequent weighings.

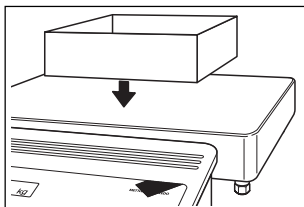

- Place the **empty** weighing container on the weighing pan.

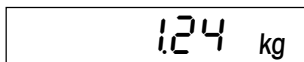

The weight of the loaded container is displayed.



- Press the «→T←» key to start the taring operation.

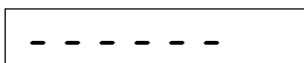

Taring runs automatically. If the scale has to wait until the weight value is stable, horizontal segments appear in the display during the wait time.

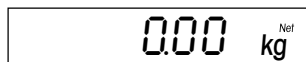

On completion of taring, the zero display and the symbol "Net" (for net weight) appears. Your scale is again ready for weighing.

Notes

- The scale can store only one tare value at a time.
- When the scale is unloaded, the stored tare value is displayed with a negative sign.
- To clear the stored tare value, unload the weighing pan and then press the «→T←» key.

3.5 Performing a simple weighing

Performing a simple weighing is described only for the sake of completeness as this operation comprises only two work steps.

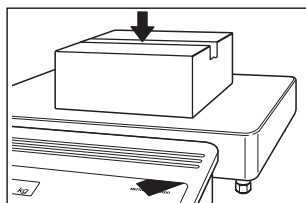

- Place the weighing sample on the pan (if you are working with a weighing container, tare this as described in the previous section).

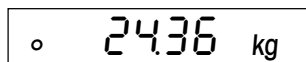

- Wait until the circular symbol of the stability detector in the bottom left corner of the display fades. Fading of the symbol indicates that the weighing result is stable.

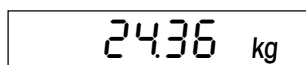

- Now read off the weight in the display.

You will find information regarding special weighing types (weighing into a container with manual or automatic taring, weighing out of a container) in section 5 of these instructions.

3.6 Printing out the weighing result and transferring data

If your scale is connected to a printer via the RS232C interface, you can print out the current weighing result with a single keystroke. If your scale is connected to a computer, you can transfer data to and from the computer. You will find additional information on the attachment of a printer in the documentation accompanying your printer. Further details on the serial interface and regarding attachment of a computer can be found in the interface description available from your METTLER TOLEDO dealer.



- Press the «→» key. As soon as the weighing result is stable, it will be transferred to the attached device.

4. The master mode

4.1 What is the master mode?

The master mode allows you to match your scale to your specific weighing needs. In the master mode you can change the settings of your scale and activate functions. The master mode contains **12 different blocks** (13 blocks if your scale is equipped with the second interface available as an option), each of which offers different selection possibilities.

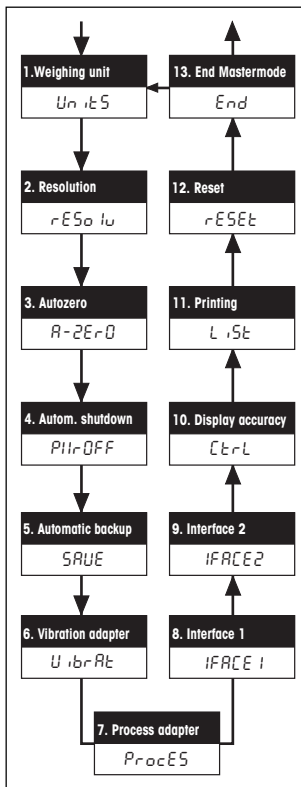

1. **Weighing unit:** Selection of the weighing unit (Units), not available with certified scales.
2. **Resolution:** Selecting the resolution of the weighing result.
3. **Autozero:** On or off switching of the automatic zero correction, not available with certified scales.
4. **Automatic shutdown:** Activation or deactivation of the automatic shutdown function (Power Off).
5. **Automatic backup:** On or off switching of the automatic backup of the last tare value (on power failure), not available with certified scales.
6. **Vibration adapter:** Matching the scale to the ambient conditions.
7. **Process adapter:** Matching the scale to the type of weighing.
8. **Interface 1:** Settings for the first interface built in as standard (Interface 1).
9. **Interface 2:** Settings for the second interface (Interface 2). This block appears only if a second interface is built in (option).
10. **Display accuracy:** Increase in the number of decimal places for test purposes (Control).
11. **Printing:** Print out (List) of the current master mode settings.
12. **Reset:** Reset of the master mode settings to the factory settings.
13. **End master mode:** Exit the master mode.

Note: You will find a complete description of the master mode with all setting possibilities in section 6.

4.2 Operation in the master mode

In this section you will learn how to work with the master mode. Information regarding the individual master mode blocks and available settings can be found in the following sections.

These are the keys you need in the master mode

YES:



For operation in the master mode, you need only two keys:

- The «» key is used for the **acceptance** of a proffered option and has the same meaning as “**YES**”.

Whenever you wish to **accept** a proffered **option**, press the «» key briefly.

NO:



- The «» key is used for the **rejection** of a proffered option and has the same meaning as “**NO**”.

Whenever you wish to **reject** a proffered **option**, press the «» key briefly.

Switching from the weighing mode to the master mode

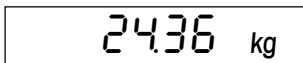

The scale operates in the normal weighing mode.



- Press the «» key and keep it pressed for approx. 5 seconds.

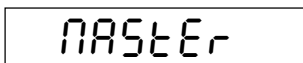

The scale now asks whether you really wish to switch to the master mode:



- **If you do not wish to switch to the master mode**, press the «» key (“NO”) and ...

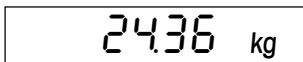

... the scale then returns to the weighing mode.



- **If you wish to switch to the master mode**, press the «» key (“YES”) and...

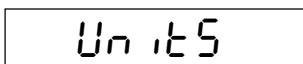

... the scale then shows the first block of the master mode (“Units” = weighing unit) directly.

Selecting the master mode blocks

Units

Following entry into the master mode, the first master mode block ("Units", not available with certified scales) is displayed.



- Press the «→T←» key ("NO") and ...

Resolution

... the display shows the next master mode block ("Resolution"). Each time the «→T←» key ("NO") is pressed, the scale switches to the next master mode block.

⋮

End

In the last master mode block you ("End") you are asked if you wish to quit the master mode.



- **If you do not wish to quit the master mode**, press the «→T←» key ("NO") again and then ...

Units

... the first master mode block ("Units", not available with certified scales) is again displayed.



- **If you wish to quit the master mode**, press the «→E» key ("YES") and ...

24.36 kg

... the scale returns to the weighing mode.

Changing the setting in a master mode block:

Units

- Select the master mode block as described above in which you wish to change a setting (in this example the block "Units" = weighing units, not available with certified scales).



- Press the «→E» key ("YES"). This tells the scale that you wish to make changes in the selected block.



The display shows the setting currently active (in this example the weighing unit "kg").



- Now press the «→T←» key ("NO") repeatedly until the desired setting is displayed.



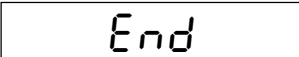

- As soon as the desired setting is displayed (in this example "lb" = pound), press the «☞» key ("YES").

You are now asked whether you wish to quit the master mode.



- **If you do not wish to quit the master mode**, press the «→T←» key ("NO") and then ...

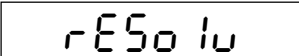

... the next master mode block is displayed (in this example "Resolution").



- **If you wish to quit the master mode**, press the «☞» key ("YES") and ...

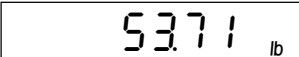

... the scale returns to the weighing mode. (Note that the weighing result is now displayed in the desired unit.)

In the following sections, you will find information on the various setting possibilities in the individual master mode blocks.

4.3 Selecting the weighing unit

Units

In the first master mode block you specify the **unit** in which the weighing result should be displayed. **This block is not available with certified scales.** The following units are available:

kg

– The weighing result is displayed in kilograms (kg). This is the **factory setting**.

t

– The weighing result is displayed in **metric tons (t)**.

g

– The weighing result is displayed in **grams (g)**.

lb

– The weighing result is displayed in **pounds (lb)**.

4.4 Selecting the resolution of the weighing result

resolution

In this master mode block you can select the resolution in which the weighing result is displayed. The settings available and the factory setting depend on the scale's **nominal load** and whether it is a certified model or not.

0.00 kg

The **example** shown here illustrates the maximum and minimum resolution of a 35 kg scale which is not certified. Other settings are available between these two extreme values.

0.200 kg

4.5 Switching the automatic zero correction on or off

A-ZERO

In this master mode block you can switch the automatic zero correction on or off. When switched on (factory setting), the zero point is automatically corrected for temperature fluctuations or contamination of the weighing pan. **This block is not available for certified scales.**

On

– Automatic zero correction **switched on**. This is the **factory setting**.

OFF

– Automatic zero correction **switched off**.

4.6 Activating or deactivating the automatic shutdown

PII OFF

When the automatic shutdown function is activated, the scale switches itself off automatically 3 minutes after the last operation presupposing that no weight is loaded. This is particularly useful if you operate your scale with the optional battery since you can then appreciably prolong the line-independent operating time of the scale. To switch the scale on again, press the «On» key.

OFF

– Automatic shutdown **deactivated**. This is the **factory setting**.

On

– Automatic shutdown **activated**.

4.7 Switching the automatic backup on or off

SAVE

When the automatic backup is activated, the current net weight and the current tare weight are automatically written to a nonvolatile memory. As soon as the scale is ready for operation again after disconnection from the power supply or after a power failure, the stored value is available. **This block is not available with certified scales.**

OFF

– Automatic backup **switched off**. This is the **factory setting**.

On

– Automatic backup **switched on**.

4.8 Setting the vibration adapter

UibrAt

The vibration adapter is used to match the scale to the ambient conditions (vibrations, drafts at scale location).

NEd

– Setting for **normal ambient conditions**. This is the **factory setting**. The scale operates at moderate speed.

LOII

– Setting for **virtually disturbance-free, stable surroundings**. The scale operates very quickly, but is more sensitive to external influences.

HI CH

– Setting for **unstable surroundings**. The scale operates more slowly than in the factory setting, but is less sensitive to external influences.

4.9 Setting the process adapter

PrOcES

The process adapter can be used to match your scale to the different types of weighing.

UNI UEr

– **Universal setting**, suitable for all types of weighings and normal weighing samples. This is the **factory setting**.

AbS

– **Absolute weighing**. This setting is suitable for checkweighings and for the weight determination of weighing samples.

dOSI NG

– **Dosing** of liquid or powdery weighing samples.

4.10 Configuring interface 1

IFACE 1

In this master mode block you can configure all parameters of the RS232C serial interface built in as standard. **You need configure the interface only if you do not obtain the desired result with the factory settings.** This master mode block is very extensive.

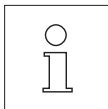

You will find a complete description of this master mode block and other useful information regarding the interface in the interface description of the Spider S scales which you can obtain from your METTLER TOLEDO dealer.

If you have made unintentional changes in this master mode block, you can **reset all settings of the interface to the factory settings**:

IFACE 1

- Select the master mode block "I-FACE 1" and then press the «» key ("YES") to confirm that you wish to make changes in this block.





rESEt 1

- You are now asked whether you wish to reset the interface settings to the factory settings. Press the «» key ("YES") to confirm that you wish to reset the settings.







- To be on the safe side, you are again asked whether you wish to restore the factory settings. Press the «» key ("YES") again to confirm.

- The scale asks you whether you now wish to exit the master mode. Press the «» key ("YES") and ...

... the scale returns to the weighing mode. The first serial interface now operates with the following **factory settings**:

Parameter	Factory setting
Data transmission protocol	XON/XOFF
Parity	Even
Data transmission rate	2400 baud (2400)
Operating mode	Printer (Print)
Data for transmission	Gross weight (Gross), tare weight (Tare), net weight (Net)
Print format	Multi (new line for every value)

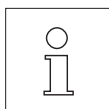
4.11 Configuring interface 2 (optional equipment)



This master mode block is displayed only if the second interface available as an option is installed!

In this master mode block you can configure all parameters of the optional second RS232C interface. **You need configure the interface only if you do not obtain the desired result with the factory settings.**

You will find a complete description of this master mode block and other useful information regarding the interface in the interface description of the Spider S scales which you received with the optional second interface.

To reset all parameters of the optional interface to the factory settings, proceed as described in the previous section.

4.12 Increasing the display accuracy (for test purposes)

Ctrl

* 24.357 kg

24.36 kg

In this master mode block you can choose whether the weighing result should be temporarily displayed with a ten times greater resolution for test purposes, i.e. with one decimal place more than with normal resolution.

- If you confirm the high resolution (with the « \Rightarrow » key), the asterisk symbol appears in the top left corner of the display and the weighing result is temporarily displayed with **high resolution**.

Note: The actual number of decimal places displayed at high resolution depends on the scale model and weighing range.

- As soon as you press the « $\rightarrow T \leftarrow$ » or « \Rightarrow » key, the asterisk symbol fades and the scale returns to the weighing mode and normal resolution.

4.13 Printing out the settings

L 1St

Pr int 1

RANGE	:	6.018 kg
RESOL	:	0.002 kg
OS 1.29	AP 4.68	
UNIT	:	kg
A-ZERO	:	ON
PWROFF	:	OFF
SAVE	:	OFF
VIBRAT	:	MED
PROCES	:	UNIVER
RS232		
PROTOK 1	:	XONOFF
PARITY 1	:	EVEN
BAUD 1	:	2400
MODE 1	:	PRINT

In this block you have the possibility to record all settings made in the master mode on the attached printer.

- If you confirm this block (with the « \Rightarrow » key), all master mode settings are printed out. If the printer is attached to the optional second interface, you can select the second interface with the « $\rightarrow T \leftarrow$ » key ("Print 2") to print out the master mode settings.

The record shown opposite is a **specimen**, depending on the selected settings and the type of printer the printout may differ from the example shown.

4.14 Resetting the settings to the factory settings

In this master mode block you have the possibility to reset the entire master mode to the factory settings.

– The master mode is reset to the factory settings if you confirm this option (with the « \Rightarrow »key).

Notes:

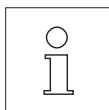

- Resetting to the factory settings affects **all master mode blocks with the exception of the two blocks for configuring the interfaces** ("I-FACE 1" and "I-FACE 2"), which can be reset in the respective block (see sections 4.10 and 4.11).
- **Proceed with caution with this option as you lose all individual settings (with the exception of the interface parameters)!**

The factory settings in the master mode blocks affected by the resetting are as follows:

Master mode block	Factory setting
Weighing units (UNITS)	Kilogram (kg)
Resolution (RESOLU)	Depends on model
Autozero (A-ZERO)	Switched on (On)
Autom. shutdown (PWR OFF)	Switched off (Off)
Autom. backup (SAVE)	Switched off (Off)
Vibration adapter (VIBRAT)	Setting for normal ambient conditions (Med)
Process adapter (PROCES)	Universal setting (Univer)

5. Special applications and functions

In addition to simple weighings, which you are already familiar with, you can also perform special weighings with your scale. You will learn these applications in the following sections.

5.1 Weighing in with manual taring

Weighing in involves the addition of a certain weight of a product to a container without weighing the container.

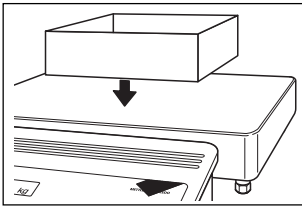

- Place the empty weighing container on the pan.



- Press the «→T←» key to tare the container.

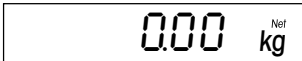

The scale is now tared and ready for weighing in.

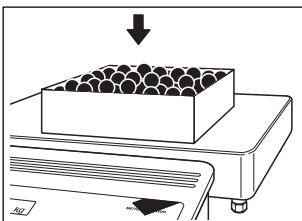

- Add the weighing sample to the container until ...

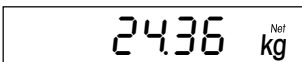

... the desired weight is reached.

5.2 Weighing out of a container

Weighing out involves determination of the weight of the weighing sample removed from a full container.

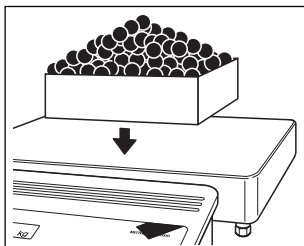

- Place the full container on the scale.



- Press the «→T←» key to tare the container.

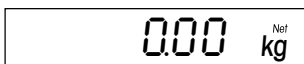

The scale is now tared and ready for weighing out.

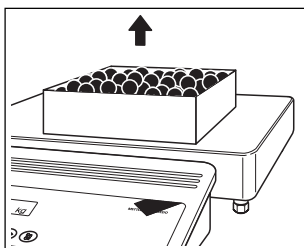



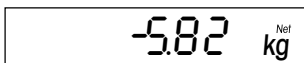

- Remove the desired amount of weighing sample from the container.

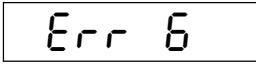

The weight of the removed weighing sample is displayed with a negative sign.

- For further weighings, tare the container again and then remove the desired amount.

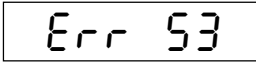
Error message/Symptom	Cause	Rectification
	Wrong weighing result: <ul style="list-style-type: none"> – Wrong zeroing of the scale – Wrong tare weight – Contact between weighing pan or sample and surroundings – Scale not horizontal 	<ul style="list-style-type: none"> • Unload scale, zero and repeat weighing • Clear tare weight or tare with correct tare weight • Ensure that weighing pan and weighing sample do not touch surrounding parts • Level scale (see section 2)
	Display remains "dark": <ul style="list-style-type: none"> – No line voltage – Scale switched off – Power cable not plugged in – Batteries discharged (in operation with optional battery pack) 	<ul style="list-style-type: none"> • Check power supply • Switch on scale • Plug in power cable • Change batteries of the battery pack or charge (see instructions for battery pack)
	No calibration: <ul style="list-style-type: none"> – The scale is not calibrated 	<ul style="list-style-type: none"> • Contact your METTLER TOLEDO dealer
	Unstable weight value: <ul style="list-style-type: none"> – The weight value did not achieve stability 	<ul style="list-style-type: none"> • Repeat operation
	EAROM error: <ul style="list-style-type: none"> – Checksum error in EAROM 	<ul style="list-style-type: none"> • Contact your METTLER TOLEDO dealer

6.2 Notes on caring for your scale

Your scale requires no maintenance work whatsoever and is extremely easy to clean. Regular cleaning assures the hygiene and also helps preserve the value of your scale.

Important notes



- Disconnect the scale from the power supply before you start the cleaning work!



- Please consult the in-plant and branch-specific regulations governing cleaning intervals and admissible cleaning agents. Never use acids, bases or powerful solvents for cleaning.

Terminal

- Clean the terminal with a suitable agent approved for your branch and with **water at a temperature of maximum 60 °C. Never use high-pressure cleaning equipment!**
- Dry the terminal immediately following cleaning with a soft, lint-free cloth.

Weighing platform

- Remove the weighing pan.
- Clean the weighing pan and the understructure of the weighing platform with a suitable agent approved for your branch and with **water at a temperature of maximum 60 °C. Never use high-pressure cleaning equipment!**



The rubber cover of the weighing cell must on no account be cleaned with sharp objects! This can cause leaks and lead to a situation where the IP protection is no longer assured!

- Dry the weighing platform immediately following cleaning with a soft, lint-free cloth.

6.3 Notes on the interface

Your scale is fitted with an RS232C serial interface and can also accommodate a second interface of the same type (as well with hardware handshake) or a RS422/485 interface available as an option. You will find information regarding the pin assignment, the commands, the configuration, attachment of peripherals (printer, computer) and on working with the interface in the separate interface description of the Spider S scales available from your METTLER TOLEDO dealer. If you purchase the second interface, the interface description is supplied.

6.4 Overview of the master mode

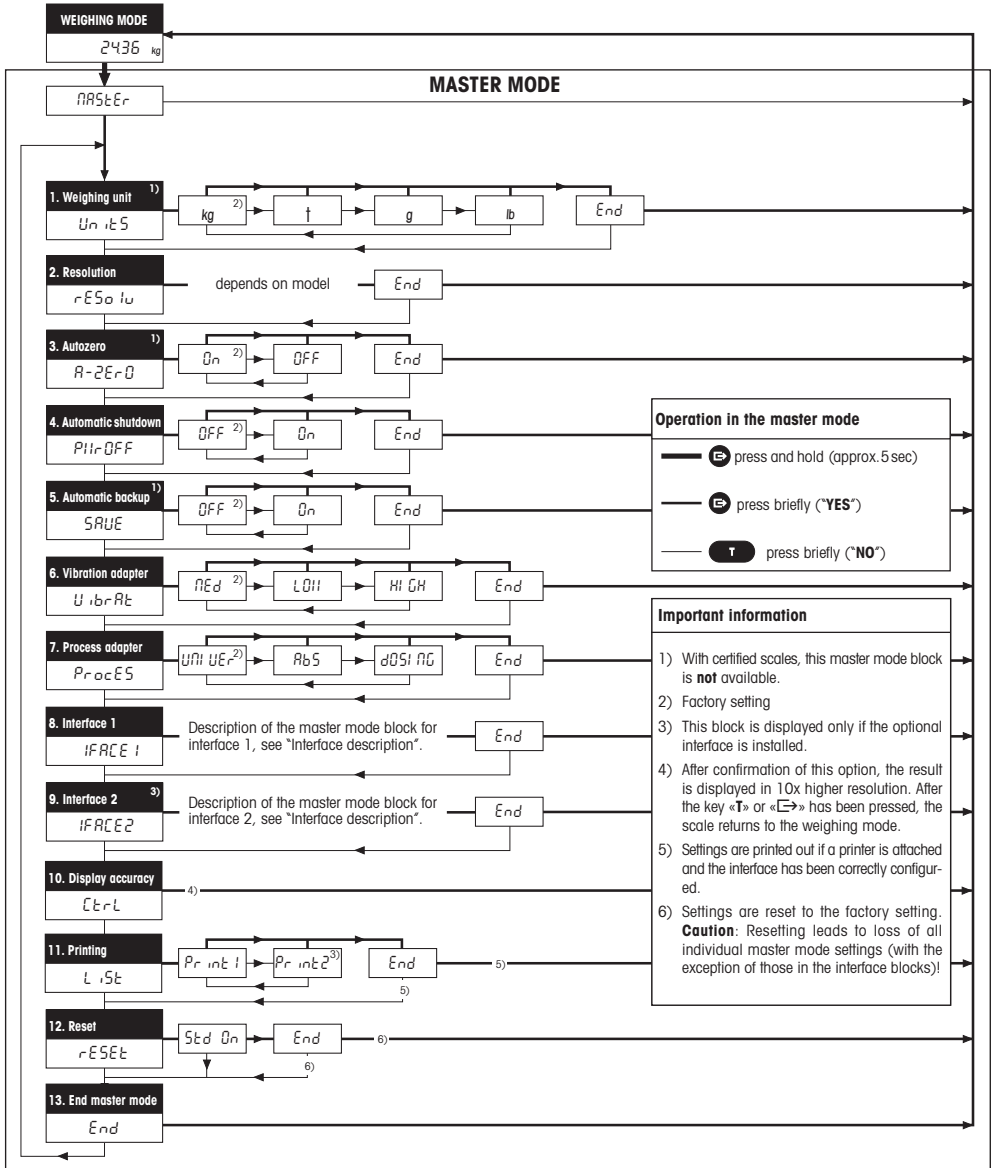

7. Technical data

7.1 General data and standard equipment of the Spider 1S scales

The following data apply to all Spider 1S models.

Vibration adapter	3 settings
Weighing process adapter	3 settings
Weighing units	kg, t, g, lb (kilogram, metric ton, gram, pound), switchable in weighing operation
Resolution	Selectable (settings depend on model)
Functions	Automatic zeroing, shutdown function, automatic backup, temporary change of display accuracy (control mode)
Display	LCD (liquid crystal display), height 20 mm, backlight
Platform supply	5 V= (admissible platform impedance: 80 ohm ... 1000 ohm)
Interface	RS232C, serial, bidirectional (optional 2nd interface) Signal level: -25 V= ... +25 V= (at $R_L \geq 3 \text{ kohm}$)
IP degrees of protection	Terminal to IP65, weighing platform to IP67
Ambient conditions	Admissible temperature range: -10 ... +40 °C Admissible relative atmospheric humidity: 90% rh Overvoltage category: II Pollution degree: 2 Application height: up to 4000 m above sea level
Power supply	Direct connection to power supply via national cable/connector 230 ..240 V (-15% / +10%), 50/60 Hz, power consumption: 80 mA 120 V (-15% / +10%), 50/60 Hz, power consumption: 160 mA
Standard equipment	Scale complete, operating instructions, open-end wrench

7.2 Data for individual models

Specifications

Model	Max. capacity	Readability	Net weight
Spider 1S-3S	3 kg	1 g	7.0 kg
Spider 1S-6S	6 kg	2 g	7.0 kg
Spider 1S-15S	15 kg	5 g	7.0 kg
Spider 1S-35S	35 kg	10 g	9.6 kg
Spider 1S-60S	60 kg	20 g	9.6 kg
Spider 1S-60LS	60 kg	20 g	14.8 kg
Spider 1S-60XLS	60 kg	20 g	24.7 kg
Spider 1S-60XXLS	60 kg	20 g	34.2 kg
Spider 1S-150S	150 kg	50 g	14.8 kg
Spider 1S-150LS	150 kg	50 g	24.7 kg
Spider 1S-150XLS	150 kg	50 g	34.2 kg
Spider 1S-300S	300 kg	100 g	24.7 kg
Spider 1S-300LS	300 kg	100 g	34.2 kg
Spider 1S-600S	600 kg	200 g	34.2 kg

Dimension drawings

Terminal

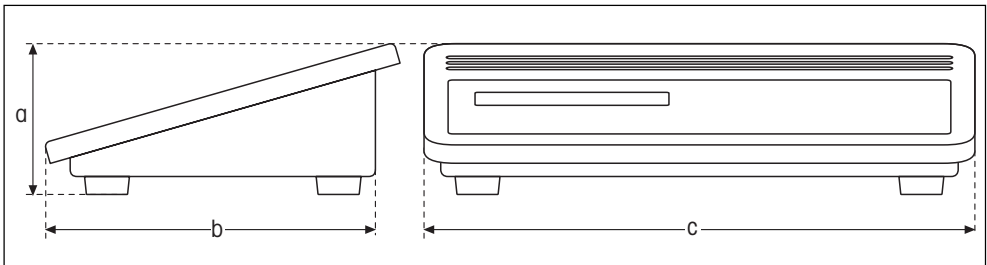

Weighing platform

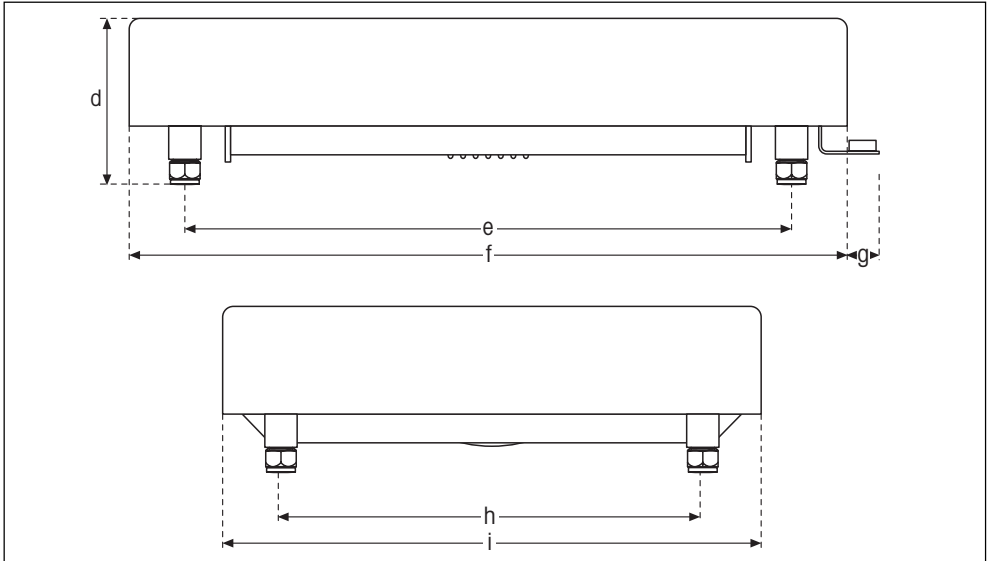

Dimensions (in millimeters)

Model	a	b	c	d ¹⁾	e	f	g	h	i
Spider 1S-3S	84	199	307	91	235	300	15	175	240
Spider 1S-6S	84	199	307	91	235	300	15	175	240
Spider 1S-15S	84	199	307	91	235	300	15	175	240
Spider 1S-35S	84	199	307	96	335	400	15	235	300
Spider 1S-60S	84	199	307	96	335	400	15	235	300
Spider 1S-60LS	84	199	307	99	435	500	15	335	400
Spider 1S-60XLS	84	199	307	104	585	650	20	435	500
Spider 1S-60XXLS	84	199	307	125	724	800	21	503	600
Spider 1S-150S	84	199	307	99	435	500	15	335	400
Spider 1S-150LS	84	199	307	104	585	650	20	435	500
Spider 1S-150XLS	84	199	307	125	724	800	21	503	600
Spider 1S-300S	84	199	307	104	585	650	20	435	500
Spider 1S-300LS	84	199	307	125	724	800	21	503	600
Spider 1S-600S	84	199	307	125	724	800	21	503	600

¹⁾ when leveling feet fully screwed in

**To protect your METTLER TOLEDO product's future:
METTLER TOLEDO service assures you of quality, measuring
accuracy and preservation of value of the METTLER TOLEDO
products for years to come.
Please send for full details of our attractive terms of service.
Many thanks.**



P21253241

Subject to technical changes and to the availability
of the accessories supplied with the instrument.

Printed on recycled paper.
Because we care.

© Mettler-Toledo GmbH 1999 21253241A Printed in Switzerland 9907/2.12

Mettler-Toledo GmbH, CH-8606 Greifensee, Switzerland, Tel. (01) 944 22 11, Fax (01) 944 30 60, Internet: <http://www.mt.com>

AT Mettler-Toledo Ges.m.b.H., A-1100 Wien, Tel. (01) 604 19 80, Fax (01) 604 28 80
AU Mettler-Toledo Ltd., Port Melbourne, Victoria 3207, Tel. (03) 9646 4551, Fax (03) 9645 3935
BE n.v. Mettler-Toledo s.a., B-1651 Lot, Tél. (02) 334 02 11, Fax (02) 378 16 65
BR Mettler-Toledo Indústria e Comércio Ltda., São Paulo, CEP 06465-130, Tel. (11) 421 5737, Fax (11) 725 1962
CA Mettler-Toledo Inc., Ontario L7R3Y8, Tel. (905) 681 7011, Fax (905) 681 1481
CH Mettler-Toledo (Schweiz) AG, CH-8606 Greifensee, Tel. (01) 944 45 45, Fax (01) 944 45 10
CN Mettler-Toledo Instr. (Shanghai) Ltd., Shanghai 200233, Tel. (21) 6485 0435, Fax (21) 6485 3351
CZ Mettler-Toledo, spol. s.r.o., CZ-12000 Praha 2, Tel. (2) 251 555, Fax (2) 242 47 583
DE Mettler-Toledo GmbH, D-35353 Giessen, Tel. (0641) 50 70, Fax (0641) 52 951
DK Mettler-Toledo A/S, DK-2600 Glostrup, Tel. (43) 27 08 00, Fax (43) 27 08 28
ES Mettler-Toledo S.A.E., E-08038 Barcelona, Tel. (03) 223 22 22, Fax (03) 223 02 71
FR Mettler-Toledo s.a., F-78222 Viroflay, Tél. (01) 309 717 17, Fax (01) 309 716 16
HK Mettler-Toledo (HK) Ltd., Kowloon HK, Tel. (852) 2744 1221, Fax (852) 2744 6878
HR Mettler-Toledo, d.o.o., CR-10010 Zagreb, Tel. (1) 660 2189, Fax (1) 660 3009
HU Mettler-Toledo Kft, H-1173 Budapest, Tel. (1) 257 9889, Fax (1) 257 7030
IT Mettler-Toledo S.p.A., I-20026 Novate Milanese, Tel. (02) 333 321, Fax (02) 356 29 73
JP Mettler-Toledo K.K., Shiroimi, J-Osaka 540, Tel. (6) 949 5901, Fax (6) 949 5945
KR Mettler-Toledo (Korea) Ltd., Seoul (135-090), Tel. (02) 518 20 04, Fax (02) 518 08 13
MY Mettler-Toledo (M) Sdn.Bhd., 47301 Petaling Jaya, Tel. (03) 703 2773, Fax (03) 703 8773
MX Mettler-Toledo S.A. de C.V., Mexico CP 06430, Tel. (5) 547 5700, Fax (5) 541 2228
NL Mettler-Toledo B.V., NL-4000 HA Tiel, Tel. (0344) 638 363, Fax (0344) 638 390
NO Mettler-Toledo A/S, N-1008 Oslo, Tel. (22) 30 44 90, Fax (22) 32 70 02
PL Mettler-Toledo, Sp. z o.o., PL-02-929 Warszawa, Tel. (22) 651 92 32, Fax (22) 42 20 01
RU Mettler-Toledo AG, 10 1000 Moskau, Tel. (095) 921 68 12, Fax (095) 921 63 53
SE Mettler-Toledo AB, S-12008 Stockholm, Tel. (08) 702 50 00, Fax (08) 642 45 62
SG Mettler-Toledo (S) Pte. Ltd., Singapore 139944, Tel. (65) 778 6779, Fax (65) 778 6639
SK Mettler-Toledo service, s.r.o., SK-83103 Bratislava, Tel. (7) 525 2170, Fax (7) 525 2173
SL Mettler-Toledo, d.o.o., SL-61111 Ljubljana, Tel. (6) 112 35 764, Fax (6) 127 4575
TH Mettler-Toledo (Thailand), Bangkok 10310, Tel. (02) 719 64 80, Fax (02) 719 64 79
TW Mettler-Toledo Pac Rim AG, Taipei, Tel. (62) 579 59 55, Fax (62) 579 59 77
UK Mettler-Toledo Ltd., Leicester, LE4 1AW, Tel. (0116) 235 0888, Fax (0116) 236 5500
US Mettler-Toledo, Inc., Worthington, Ohio 43085, Tel. (614) 438 4511, Fax (614) 438 4755
US Mettler-Toledo, Inc., Hightstown, NJ 08520-0071, Tel. (609) 448 3000, Fax (609) 586 5451

For all other countries: Mettler-Toledo GmbH, PO Box VI-400, CH-8606 Greifensee, Tel. (01) 944 22 11, Fax (01) 944 31 70