

Living up to Life



User Manual

Leica S series



General Instructions

Safety concept

Before using your stereomicroscope for the first time, please read the "Safety concept" brochure included with your instrument. It contains additional information about handling and care.



Use in clean rooms

The Leica S series can be used in clean rooms without any problems.

About cleaning

- Do not use any unsuitable cleaning agents, chemicals or techniques for cleaning.
- Never use chemicals to clean colored surfaces or accessories with rubberized parts. This could damage the surfaces, and specimens could be contaminated by abraded particles.
- In most cases, we can provide special solutions on request. Some products can be modified, and we can offer other accessories for use in clean rooms.

Servicing

- Repairs may only be carried out by Leica Microsystems-trained service technicians. Only original Leica Microsystems spare parts may be used.

Responsibilities of person in charge of instrument

- Ensure that the Leica stereomicroscope is operated, maintained and repaired by authorized and trained personnel only.



Important Safety Notes

User Manual

The individual modules of the Leica stereomicroscope include an interactive CD-ROM with all relevant user manuals in several languages. Keep it in a safe place, and readily accessible to the user. User manuals and updates are also available for you to download and print from our web site www.leica-microsystems.com.

This User Manual describes the special functions of the Leica StereoZoom® stereomicroscopes (S series) and contains important instructions for their operational safety, maintenance, and accessories.

The "Safety Concept" booklet contains additional safety information regarding the service work, requirements and the handling of the stereomicroscope, accessories and electrical accessories as well as general safety instructions.

You can combine individual system articles with articles from external suppliers (e.g. cold light sources, etc.). Please read the user manual and the safety requirements of the supplier.

Before installing, operating or using the instruments, read the user manuals listed above. In particular, please observe all safety instructions.

To maintain the unit in its original condition and to ensure safe operation, the user must follow the instructions and warnings contained in these user manuals.



Symbols Used

Warning of a danger



This symbol indicates especially important information that is mandatory to read and observe.

Failure to comply can cause the following:

- Hazards to personnel
- Functional disturbances or damaged instruments

Warning of hazardous electrical voltage



This symbol indicates especially important information that is mandatory to read and observe.

Failure to comply can cause the following:

- Hazards to personnel
- Functional disturbances or damaged instruments

Danger due to hot surface.



This symbol warns against touching hot surfaces, e.g. those of light bulbs.

Important information



This symbol indicates additional information or explanations that intend to provide clarity.

Explanatory notes

- This symbol within the text stands for additional information and explanations.

Figures

- (1) Numbers in parentheses within the descriptions relate to the figures and the items within those figures.



Safety Instructions

Description

The individual modules fulfill the highest requirements for observation and documentation of Leica stereomicroscopes of the S series.

Intended use

- Refer to "Safety Concept" booklet

Non-intended use

- Refer to "Safety Concept" booklet

Never use S series microscopes or their components for surgical procedures (e.g. on the eye) unless they are specifically intended for that purpose.

The devices and accessories described in this User Manual have been tested with regard to potential hazards. The responsible Leica affiliate must be consulted whenever the instrument is altered, modified or used in conjunction with non-Leica components that are outside of the scope of this manual!

Unauthorized alterations to the instrument or noncompliant use shall void all rights to any warranty claims!

Place of use

- Refer to "Safety Concept" booklet
- Electrical components must be placed at least 10 cm away from the wall and from flammable substances.
- Avoid large temperature fluctuations, direct sunlight and vibrations. These conditions can distort measurements and micrographic images.
- In warm and warm-damp climatic zones, the individual components require special care in order to prevent the build-up of fungus.

Responsibilities of person in charge of instrument

- Refer to "Safety Concept" booklet

Ensure that:

- The S series stereomicroscopes and accessories are operated, maintained and repaired by authorized and trained personnel only.
- All operators have read, understood and observe this User Manual, and particularly the safety instructions.



Safety Instructions (continued)

Repairs, service work

- Refer to "Safety Concept" booklet
- Only original Leica Microsystems spare parts may be used.
- Before opening the instruments, switch off the power and unplug the power cable.



Touching the live circuit can cause injury.

Transport

- Use the original packaging for shipping or transporting the individual modules of the Leica S stereomicroscopes and the accessory components.
- In order to prevent damage from vibrations, all moving parts that (according to the user manual) can be assembled and disassembled by the customer should be disassembled and packed separately.

Integration in third-party products

- Refer to "Safety Concept" booklet

Disposal

- Refer to "Safety Concept" booklet

Legal regulations

- Refer to "Safety Concept" booklet

EC Declaration of Conformity

- Refer to "Safety Concept" booklet



Safety Instructions (continued)

Health risks



Workplaces with stereomicroscopes facilitate and improve the viewing task, but they also impose high demands on the eyes and holding muscles of the user. Depending on the duration of uninterrupted work, asthenopia and musculoskeletal problems may occur. For this reason, appropriate measures for reduction of the workload must be taken:

- Optimal arrangement of workplace, work assignments and work flow (changing tasks frequently).
- Thorough training of the personnel, giving consideration to ergonomic and organizational aspects.

- The ergonomic optical design and construction of the Leica S stereomicroscopes are intended to reduce the exertion of the user to a minimum.



Direct contact with eyepieces is a potential transmission method for bacterial and viral infections of the eye.

The risk can be kept to a minimum by using personal eyepieces for each individual or detachable eyecups.

Table of Contents

General Instructions	2
Important Safety Notes	3
Symbols Used	4
Safety Instructions	5
Table of contents	8

Leica S Series

Congratulations!	11
The Modular Design: Everything is Relative	12
What your stereomicroscope has to offer you	13
The model series	14
On We Go	15

Assembly

Installing the basic equipment (overview)	17
Focusing column	18
Sub-base for transmitted light and cold light source	19
Optics carrier and additional objective	20
Available graticules	21
Inserting graticules	22
Eyepieces	23
Leica LED illuminators	24
Mounting a camera (Leica S6 D and S8 APO)	25

Quick Start Guide

A stereomicroscope of the S series in overview	27
Tips for working ergonomically	28
Using the Eyepieces	29
The correct interpupillary distance	30
Focusing	31
Switching magnification (zooming)	32
Limiting zoom range	33
Regulating the resistance of the focusing drive	35
Changing the position of the optics carrier	36
Diopter settings and parfocality: 1 adjustable & 1 fixed eyepiece	37
Dioptic correction with two adjustable eyepieces	40

Photography & Video

Photography & Video	44
Photography with the Leica S6 D and S8 APO	45

Dimensional drawings in mm

Leica S6 E (S4 E / S6 T) with incident light and transmitted light illumination	47
Leica S6	48
Leica S6 D with incident light and transmitted light illumination	49
Leica S8 APO with incident light and transmitted light illumination	50



Specifications

Overview of technical features	52
Specifications	53

Appendix

Calculating the total magnification/field of view diameter	55
Troubleshooting	56
Care, Maintenance, Contact Persons	57

Leica S series





Congratulations!

Congratulations on obtaining your new Leica StereoZoom® line stereomicroscope (S series). We are convinced it will exceed your expectations, as this instrument embodies all the qualities you associate with the name Leica Microsystems: excellent objectives, high-quality engineering, and reliability. Furthermore, the modular design ensures that the Leica stereomicroscope adapts perfectly to your needs – no matter which accessories you require for your tasks.

Thanks to the parfocal system with simultaneously large working distances and object fields, you can always view your microscopic specimens accurately – from the complete image to the finest detail.

Though the reliability and robustness of Leica stereomicroscopes is world-renowned, like any high-tech product, the Leica S series requires a certain degree of care and attention. Therefore, we recommend that you read this manual. It contains all the information you need regarding operation, safety and maintenance. Simply observing a few guidelines will ensure that even after years of intensive use, your stereomicroscope will continue to work as smoothly and reliably as on the very first day.

We wish you the best of success in your work! after all, you are now equipped with the best tool!

The Modular Design: Everything is possible

The Leica S series provides a high degree of flexibility in choosing equipment, thanks primarily to the modular configuration and the compatibility that Leica has painstakingly maintained for decades. The optics carriers, eyepieces, stands and more can be combined in any way you choose, allowing you to create the stereomicroscope that best suits your needs.

Despite this, you will notice that the controls and individual components do not differ significantly. Whichever configuration you choose, you will quickly feel right at home with your new stereomicroscope.

Have a special request? Let us know!

Leica Microsystems enjoys an exceptional reputation when it comes to devising customer-specific solutions. If you have a special request that cannot be met with standard parts, contact your Leica consultant. He or she has a solution for every application.





What your stereomicroscope has to offer you

The optical system of the Leica StereoZoom® line consists of two beam paths converging at 12°. The objective pairs of each optical path are positioned close together, so the stereomicroscopes can be of very "slender" design, especially towards the base of the instrument. The advantage: The advantages of this design are that it has a small space requirement for use on bonders and in machine applications, unobstructed access to specimens, plenty of space for tools and a completely clear view of the object field.

The Greenough system enables cost-effective correction of aberrations such as chromasia, image field curvature, and distortion with minimal effort. In the new Leica StereoZoom® line, the optimum corrected center of the objective is used for the image. This provides superior optical performance with large, level and undistorted fields of view and chromatically optimized, high-contrast images.

ESD protection

The Leica S4 E, S6 E, S6, S6 D and S8 APO, including its cold light source and stand, is made from highly conductive material with surface resistivity of $2 \cdot 10^{11}$ Ohm/square, with a discharge time of <2 seconds, 1000 V to 100 V.

The Leica S6 T terminator version for highly complicated working ranges and the T incident light stand consist of a dissipative material with a surface resistivity of 10^2 - 10^6 Ohm/square and a discharge time of <0.1 seconds from 1000 V to zero.

Photography

The StereoZoom® models Leica S6 D and S8 APO are equipped with an integrated video/phototube, which allows the simple, fast mounting of digital cameras

Apochromatic correction

The Leica S8 APO is a completely apochromatically corrected Greenough system. The modern optical technology of the StereoZoom® Leica S8 APO corrects chromatic aberration perfectly, removes bothersome color seams and displays pin-sharp images of even the finest enlarged detail. Contrast, brilliance, image sharpness, resolution, color fidelity and image precision are unsurpassed. The benefit of apochromatic correction is best seen in specimens that have a fine, low-contrast structure such as large animal cells, cilia plants or metallic microelectronic structures.

The technical features of the individual models are found on page [52](#).



The model series





On We Go

If your new Leica stereomicroscope has already been assembled and commissioned by your Leica consultant, click here to skip through the installation instructions and go directly to the Quick Start Guide on Page 26.

If, on the other hand, you are assembling the stereomicroscope yourself, continue with the "Assembly" chapter, which begins on Page 16.

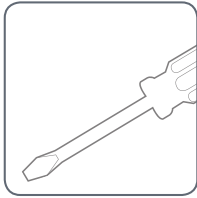



Assembly

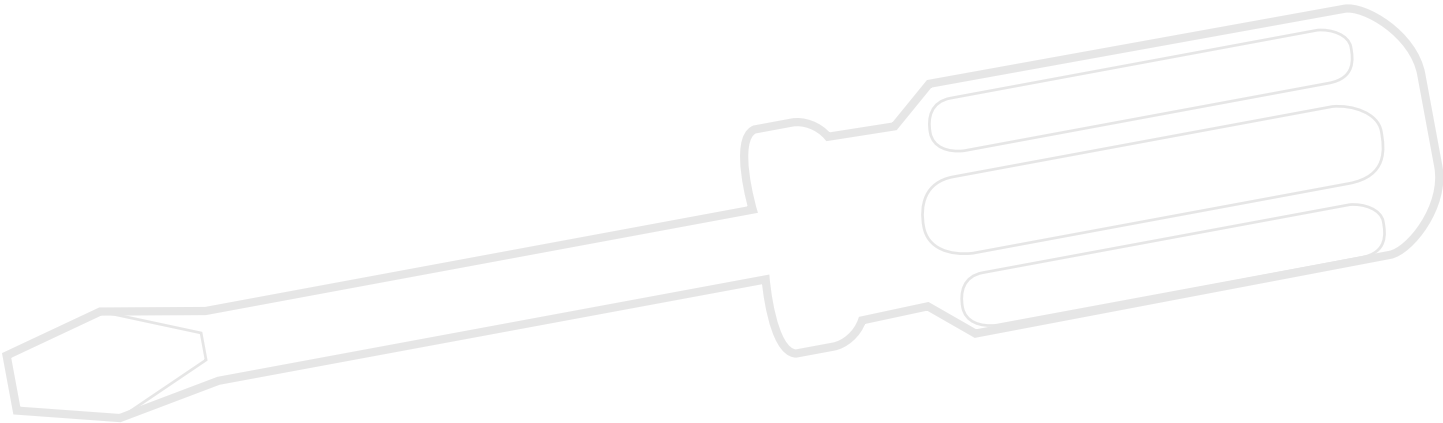

Installing the basic equipment (overview)

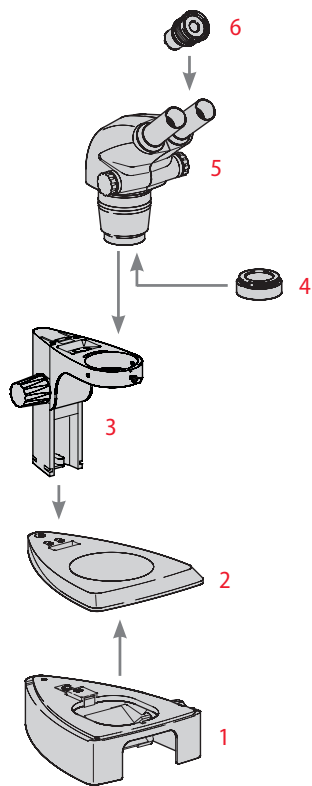

1. Sub-base for transmitted light with glass stage plate
2. Incident light base with stage plate
3. Focusing column with microscope carrier
4. Additional objective, optional
5. StereoZoom® optics carrier
6. Eyepieces, fixed and/or adjustable

Focusing column



Never unscrew the 3 screws on the right side of the focusing column.



Focusing column on the incident light base

1. Remove the stage plate.



2. Route the 3 hollow screws from below through the base plate and screw these securely into the focusing column.



3. Insert the stage plate back into place.

Sub-base for transmitted light and cold light source

1. Remove the glass stage plate.

2. Pull the locking mechanism forward.

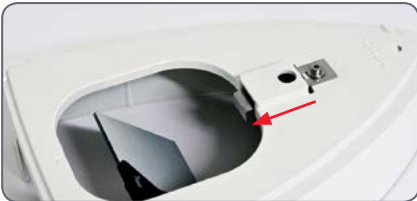

4. Press the locking mechanism backward. The incident light base and the sub-base for transmitted light are now connected.



3. Set the incident-light stand to the sub-base for transmitted light and engage it with the connection screw.



5. Insert the glass stage plate.



6. Insert the universal light guide in the opening at the rear.



 Additional information can be found in the User Manual for cold-light source Leica KL300 LED.



Optics carrier and additional objective

Optics carrier

1. Insert the optics carrier carefully in the microscope carrier and fasten it in the desired position with the clamping screw.



Additional objective (optional)

1. Screw the desired objective counterclockwise into the optics carrier.



Protective objective glass (optional)

1. Screw the objective protective glass directly onto the StereoZoom® or on the additional objective.





Available Graticules

 The optional graticules enable measurement and, in addition, provide valuable information when comparing and capturing still images of the specimens. Insert the graticule before you set the eyepiece in place.

Available Graticules

The following graticules and objective micrometers for calibrating may be ordered:

- Graticule 10 mm/0.1 mm
- Graticule 5 mm/0.1 mm
- Graticule 5 mm/0.05 mm
- Graticule 100 Div./0.002"
- Graticule 100 Div./0.001"
- Graticule 150 Div./0.0005"
- Crosshairs
- Stage micrometer 50 mm, 0.1/0.01/ mm graduation
- Stage micrometer 1", 0.001" graduation

Inserting graticules

 Graticules can be inserted in the adjustable eyepieces and the in the eyepieces for eyeglass wearers.

 The procedure for taking measurements is described in the "Measuring" user manual.

Inserting graticule(s)

1. Use the stereomicroscope to determine the side on which the scale is inscribed. The scale must not appear reversed.
2. Remove the insert from the bottom of the eyepiece and place it on the bench with the knurled side down.



3. Hold the graticule by the edges to avoid leaving fingerprints, and push it into the holder from the side.



4. Replace the insert in the eyepiece and press it firmly into place.



5. Insert the eyepiece in the tube and turn the eyepiece in the tube to align the graticule correctly.

Eyepieces

 You can use your Leica StereoZoom® together with a fixed or adjustable eyepiece. For models in which a graticule is included in an eyepiece for measurement or photography, two eyepieces are necessary. We recommend that you also equip the high-powered StereoZoom® Leica S8 APO with two adjustable eyepieces.

Inserting the eyepieces

1. Push eyepieces as far as they will go into the tubes.



2. Check that the eyepieces are seated firmly and precisely in place.

Risk of infection

 Direct contact with eyepieces is a potential transmission method for bacterial and viral infections of the eye. The risk can be kept to a minimum by using personal eyepieces for each individual or detachable eyecups.

Leica LED illumination

 The Leica KL300 LED cold light source with its fiber-optic light guides is ideally suited for the Leica S4 E, S6 E, S6 and S6 T stereomicroscopes. A number of matching adapters are available for connecting the Leica KL300 LED cold light source to various stereomicroscope stands and for stand-alone operation.

For detailed information about installation and use, please refer to the user manual for the Leica KL300 LED.

 Please note that the universal light guide on the Leica S8 APO can only be used with the light arm mounted on the side.

High-output illuminators

 For higher demands, such as photography or in use combination with the Leica S8 APO, we offer different high-performance transmitted light stands and LED incident light illumination, as in the Leica LED3000 series, for example. Please ask your Leica consultant about the options.



Camera design (Leica S6 D and S8 APO)

 The Leica S6 D and S8 APO are equipped with an integrated video/phototube, which allows the simple, fast mounting of digital cameras for photos and video. Please ask your Leica consultant about the options.

 Detailed information about the available camera systems, accessories and the software packages from Leica can be found in the corresponding manuals.

Installing the camera

1. Remove the protective dust cover from the video/projection lens (C-mount adapter) and the microscope camera.



2. Screw the camera into the video/projection lens (C-mount).



3. Insert the unit into the video/photo output of the stereomicroscope and screw it in.



 Always close the video/photo output with the protective dust cover if no camera is installed.

Quick Start Guide



An overview of an S series stereomicroscope

- 1 Magnification changer, right drive knob with magnification scale
- 2 S6/S8 models: Stop for zoom limit
- 3 Focusing drive
- 4 Fixing screw for optics carrier in the microscope carrier
- 5 Adjustable tube: Interpupillary distance adjustable from 55 to 75 mm
- 6 Eyepieces
- 7 Threads for fastening the light arm (both sides and rear)
- 8 Illumination Leica LED3000 SLI
- 9 Illumination Leica LED3000 RL
- 10 Leica microscope camera
- 11 C-mount adapter and video/photo tube

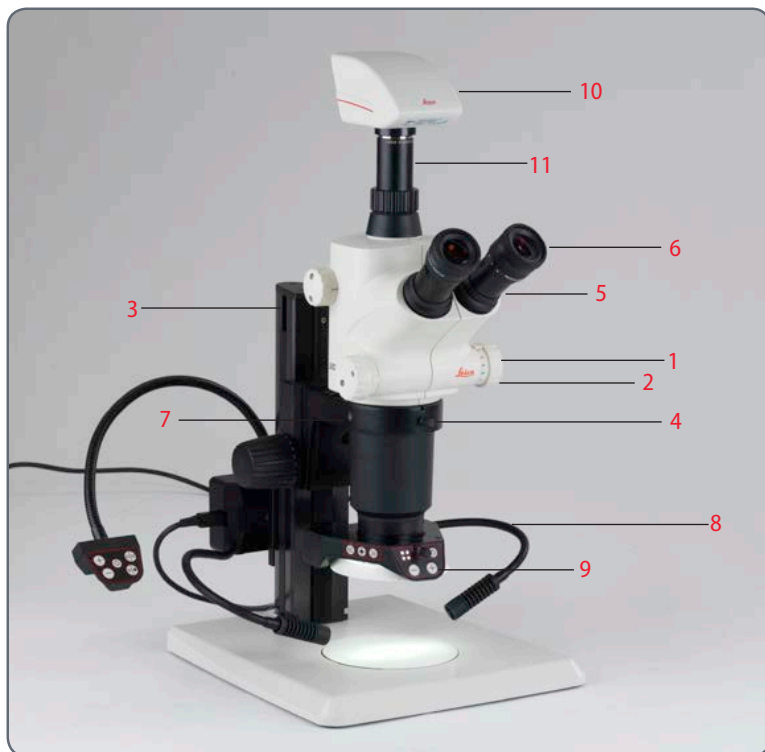

Tips for working ergonomically



Align your stereomicroscope optimally. You must configure the settings described here precisely in order to be able to take full advantage of its outstanding optical and ergonomic advantages.

- Align your workstation optimally. Consider the height of the bench and chair.
- Use the whole seat surface and the backrest.
- Ensure that your lower arms are supported.
- When carrying out other tasks, perform exercises to relax and relieve muscle tension.

Ergonomic objectives

The ErgoObjective for the Leica S4 E and all S6 models provides for fatigue-free work. The ErgoObjective 0.6 – 0.75 \times with an adjustable working distance of 77 – 137 mm and the ErgoObjective 0.7 – 1.0 \times with an adjustable working distance of 48 – 98 mm allow the fine adjustment of the working distance, the magnification and the viewing level without time-consuming changing of lenses.

The Leica S6, with a 60° viewing angle, offers optimum viewing height on the inclined stereomicroscope.



Using the Eyepieces

 The eyepieces form the connection between the tube and the eye of the observer. Simply push them into the tube and they are ready to use.



What does "parfocal" mean?

 "Parfocal" means that a specimen continues to remain exactly in focus, even if the magnification on the stereomicroscope is modified. All stereomicroscopes from Leica Microsystems are parfocally matched. However, the parfocality requires a personal dioptric correction for the user.

Dioptric Correction

In order to parfocally match the stereomicroscope, at least one eyepiece with dioptric correction is necessary. The setup is described on the following pages:

- With one adjustable and one fixed eyepiece: from page [37](#).
- With two adjustable eyepieces: from page [40](#).

If you do not wear glasses:

Depending on the preferences of the observer, eyecups can be used.

 To avoid eye infections, we recommend that every user uses his or her own pair of eyecups.

If you wear glasses:

 Eyeglass wearers must remove or fold back the eyecups (Fig. below left), as otherwise they cannot see the entire field of view.





The correct interpupillary distance

 The interpupillary distance is correctly set if you see a single circular image field when looking at a specimen.

If you are still a novice microscope user, you may need a short time to become accustomed to this. Not to worry - after a little while, it will become automatic.

Reference value

The interpupillary distance can be set between 55 and 75 mm.

 An "exit pupil distance" is the distance between eye and eyepiece. With the 10×/23B wide-field eyepiece for eyeglass wearers, it is approx. 22 mm. For those who do not use the eyepiece for eyeglass wearers, it is 12 mm.

Setting the eye distance

1. Bring the eyes slowly to the eyepieces.
2. Push the tubes together or apart with both hands until you see a single round, circular image field without shadows with both eyes.

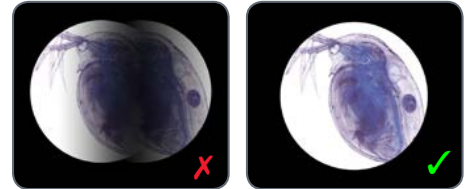

Focusing

 Focusing raises and lowers the stereomicroscope using the focusing drive. The specimen detail is brought into sharp focus as soon as it is in the focal point of the objective.



 The focusing drive can be operated either left- or right-handed.

Focusing

1. Align the specimen under the objective.



2. Set the lowest magnification level.

 At the lowest magnification, the desired specimen detail can be easier to localize due to the large field of view.

3. Look into the eyepieces and insert the desired specimen detail in the center.
4. Focus on the specimen with the drive knob.

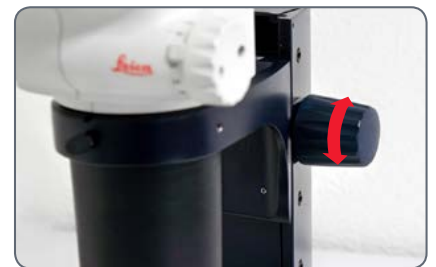

Changing magnification (zooming)

 All stereomicroscopes of the S series allow a continuous magnification change. The magnification changer can be operated with the left and the right hand. The image scale is shown on the right drive knob.

 The basis for the calculation of the total magnification and the field of view can be found on page [26](#).

Changing magnification

1. Look into the eyepieces.
2. Focus on the object (see page [16](#)).
3. Rotate the magnification changer until the desired magnification is configured.



Limiting zoom range

With the S6 models and the S8 APO, the zoom range can be limited at the top and bottom. In the same manner, a fixed magnification level can be set. The following example shows the limit to the range between 1 to 3.2.

Defining the lower limit

1. Loosen the hollow screw on the left drive knob with the Allen key provided.



2. Turn the right drive knob to position "1".



3. Set the stop on the left drive knob forward until it touches the built-in zoom stop.



4. Carefully tighten the Allen screw.

Continued on next page.

Limiting zoom range (continued)

Defining the upper limit stop

1. Loosen the hollow screw on the right drive knob with the Allen key provided.
3. Set the stop backward on the right drive knob until it touches the built-in zoom stop.



2. Turn the right drive knob to position "3.2".
4. Carefully tighten the allen screw.



Regulating the resistance of the focusing drive

Adjusting the resistance

Is the focusing drive too loose or too tight? Does the equipment tend to slide downwards? The resistance can be adjusted individually depending on the equipment weight and personal preferences as follows:

1. Grip the outer drive knobs with both hands and turn them towards each other until the desired resistance is reached during focusing.





Changing the position of the optics carrier

 The optics carrier can be turned side-ways in the microscope carrier if the user wants to work from the side.

Changing position

1. Unscrew the clamping screw.





2. Turn the optics carrier laterally to the desired position.



3. Carefully tighten the clamping screw.

Diopter settings and parfocality: 1 adjustable & 1 fixed eyepiece

 If you set the diopters on the adjustable eyepiece exactly as described, the image will remain equally sharp and constant (parfocal) from the lowest to the highest magnification. This means you do not have to refocus when changing magnification. The focus needs to be readjusted only if you want to view a specimen detail that is located higher or lower. Use this advantage as often as possible, it is not available on all stereomicroscopes.

 The diopters can be set between +5 and -5.



 The following adjustments have to be carried out only once by each user. Using reticules leads to slightly deviated settings, which are described in the user manuals on the reticules (measurement).

Adjusting the diopter settings

1. With Leica S6 D and Leica S8 APO, turn the rotary knob to the "Vis" setting.



2. Turn the dioptic correction on the adjustable eyepiece to the center position.



Continued on next page

Diopter settings and parfocality: 1 adjustable & 1 fixed eyepiece (continued)

3. Place a flat specimen under the objective.

4. Set the lowest magnification level.



5. Observe the specimen through the eyepieces and bring it into sharp focus with the focusing drive.

6. Set the highest magnification level.

7. Optimize the focusing with the focusing drive.



8. Set the lowest magnification level.

9. Turn the eyelens of the eyepiece as far as it will go in the "+" direction, without looking into the eyepieces while doing so.

10. Close your eye on the fixed eyepiece and look with the other eye into the adjustable eyepiece.

11. Rotate the eyelens of the eyepiece slowly in the "-" direction until the eye can see the specimen sharply.

Continued on next page





Diopter settings and parfocality: 1 adjustable & 1 fixed eyepiece (continued)

Checking parfocality

1. Select the highest magnification level.
2. Monitor the specimen; if necessary, refocus it slightly.
3. Change from the highest to the lowest magnification. The sharpness should be constant (parfocal). If this is not the case, repeat this procedure.

Dioptric correction with two adjustable eyepieces

 If you set the diopters on the adjustable eyepiece exactly as described, the image will remain equally sharp and constant (parfocal) from the lowest to the highest magnification. This means you do not have to refocus when changing magnification. The focus needs to be readjusted only if you want to view a specimen detail that is located higher or lower. Use this advantage as often as possible, it is not available on all stereomicroscopes.

 The diopters can be set between +5 and -5.



 The following adjustments have to be carried out only once by each user. Using reticules leads to slightly deviated settings, which are described in the user manuals on the reticules (measurement).

Adjusting the diopter settings

1. With Leica S6 D and Leica S8 APO, turn the rotary knob to the "Vis" setting.



2. Turn the dioptic correction on both eyepieces to the center position.



Continued on next page

Dioptric correction with two adjustable eyepieces (continued)

3. Place a flat specimen under the objective.

4. Set the lowest magnification level.



5. Observe the specimen through the eyepieces and bring it into sharp focus with the focusing drive.

6. Set the highest magnification level.

7. Optimize the focusing with the focusing drive.



8. Set the lowest magnification level.

9. Turn the eyelens of the eyepiece as far as it will go in the "+" direction, without looking into the eyepieces while doing so.

10. Look through the eyepieces and close one eye.

11. With the other eye, monitor the specimen and turn the eyelens of the eyepiece slowly in the "-" direction, until this eye sees the specimen sharply.

12. Repeat steps 10 and 11 with the other eye.

Continued on next page



Dioptric correction with two adjustable eyepieces (continued)

Checking parfocality

1. Select the highest magnification level.
2. Monitor the specimen; if necessary, refocus it slightly.
3. Change from the highest to the lowest magnification. The sharpness should be constant (parfocal). If this is not the case, repeat this procedure.



Photography & Video

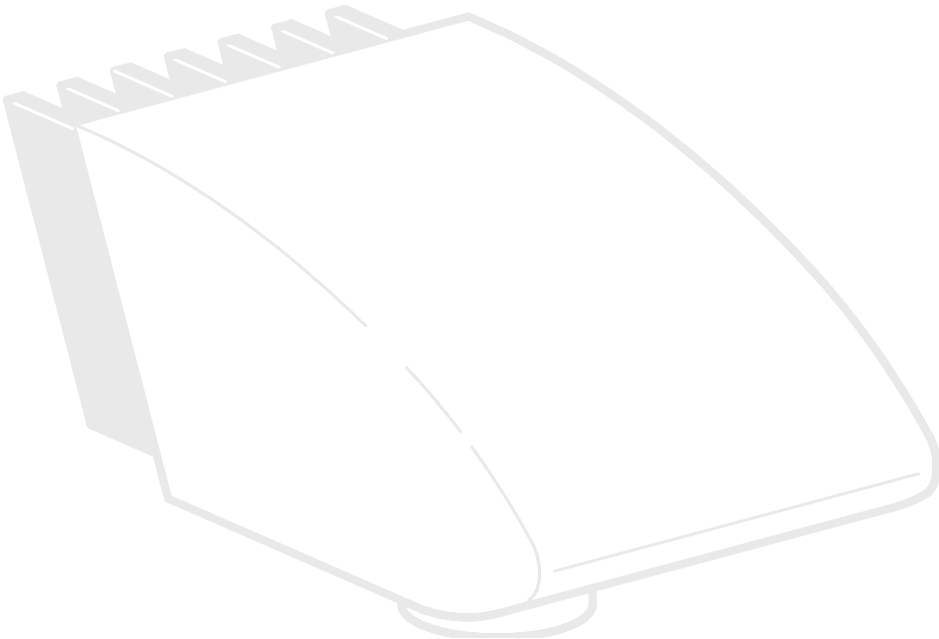

Photography & Video

For most stereomicroscope users, digital documentation has become an invaluable part of their work. Research results can be presented in an appealing form, while measurements on the digital image provide clarity.

Adapters

If camera control using the Leica Application Suite is not required, conventional mirror reflex and rangefinder cameras from third-party manufacturers can be used. Leica Microsystems offers various adapters for these.

Leica DFC cameras

If you require absolute control over the camera and need the capability for measurement, evaluation and more in addition to photography, the digital Leica DFC cameras are exactly right for you. Together with the Leica Application Suite, they provide virtually limitless freedom of use. For additional information about Leica cameras, refer to the camera's documentation.



Leica Application Suite

The "Leica Application Suite", or "LAS" for short, is, as it were, the digital extension of your stereomicroscope. With it, you can not only take images, but also control the illumination, the camera and more. For additional information, refer to the LAS online help.

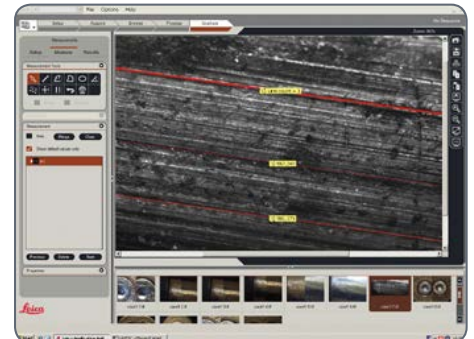





Photography with the Leica S6 D and S8 APO

 The observation beam path and the photobeam path can be switched. For this, the light splitting is influenced as follows:

- Position "Vis": 100% light in both eyepieces, but no light in the video/photo beam path
- Position "Doc": 100% light in the right eyepiece, but no light in the left eyepiece. 100% of the light crosses the video/photo beam path



 The focusing and the framing are done with the left eyepiece (video/photo beam path).

 Flat specimens are sometimes partially blurry on the left and right edge of the image. This blurring is based on laws of optics and does not mean there is a malfunction of the camera or the microscope.

Capturing images and videos

1. If the image detail and image sharpness are set to your satisfaction, switch on the "Doc" setting and capture your image.



Dimensional drawings in mm

Leica S6 E (S4 E / S6 T) with incident light and transmitted light illumination

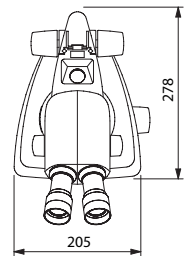
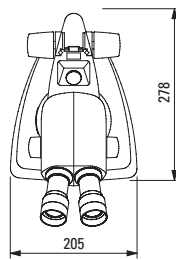
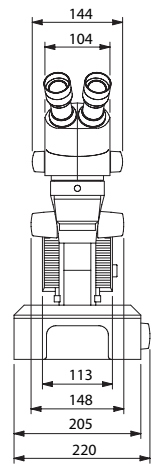
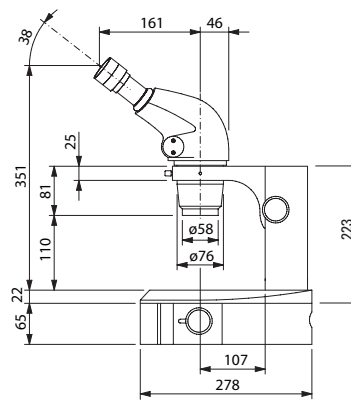
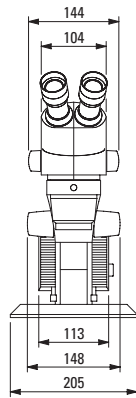
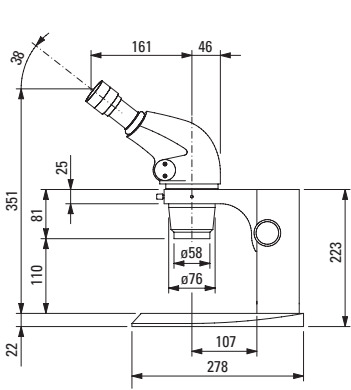



Leica S6

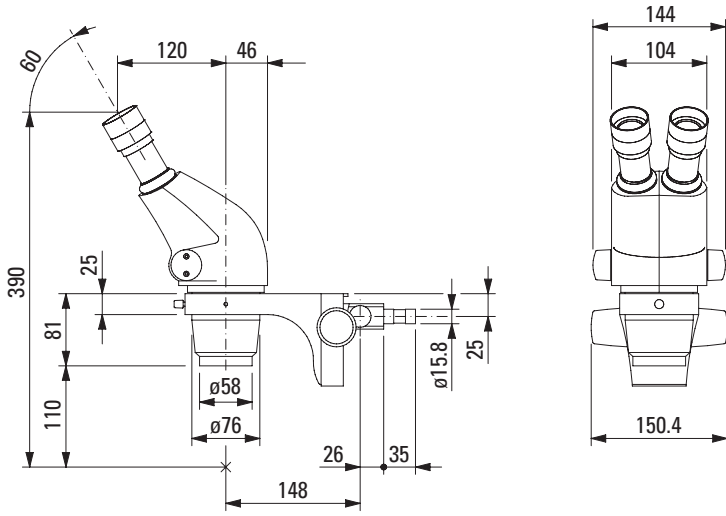



Leica S6 D with incident light and transmitted light illumination

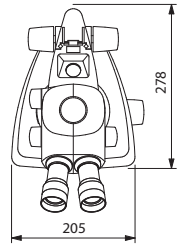
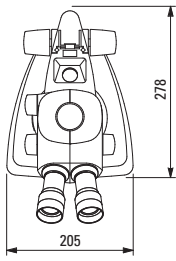
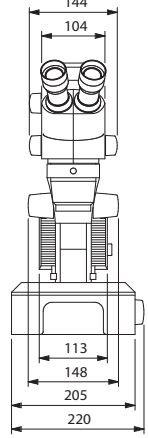
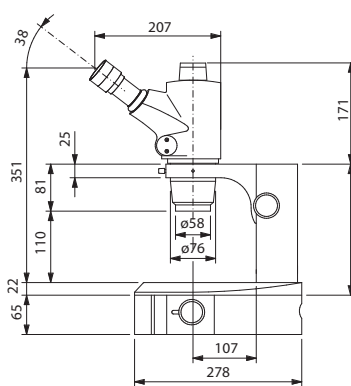
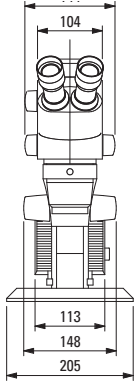
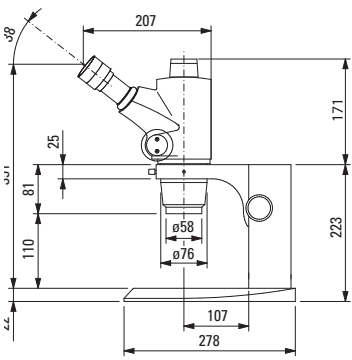

Leica S8 APO with incident light and transmitted light illumination

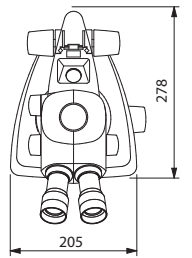
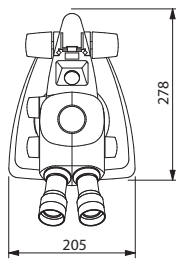
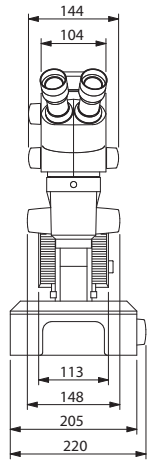
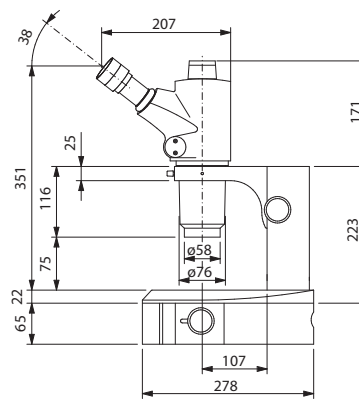
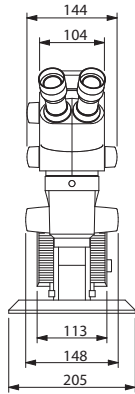
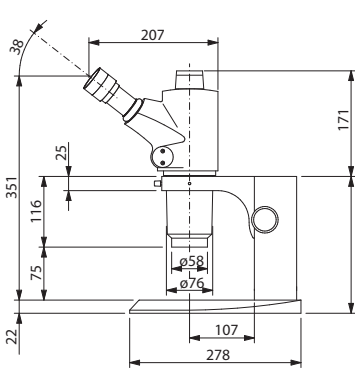



Technical data



Overview of technical features

StereoZoom®	Zoom	Enlargement	Viewing angle	Extras
Leica S4 E	4.8:1	6.3x-30x	38°	ErgoObjective™
Leica S6 E	6.3:1	6.3x-40x	38°	ErgoObjective™
Leica S6	6.3:1	6.3x-40x	60°	ErgoObjective™
Leica S6 T	6.3:1	6.3x-40x	38°	Terminator ErgoObjective™
Leica S6 D	6.3:1	6.3x-40x	38°	Video photo tube ErgoObjective™
Leica S8 APO	8:1	10x-80x	38°	Apochromatic Greenough system Apochromatic zoom Apochromatic objectives Video photo tube

StereoZoom® is a trademark registered in the Principal Register of the US Patent and Trademark Office.

Technical data

StereoZoom®	Leica S4 E	Leica S6	Leica S6 E	Leica S6 T	Leica S6 D	Leica S8 APO	
Optical system, lead-free	12°-Greenough using best-corrected central part of the objective	12°-Greenough using best-corrected central part of the objective	12°-Greenough using best-corrected central part of the objective	12°-Greenough using best-corrected central part of the objective	12°-Greenough using best-corrected central part of the objective	12°-Greenough using best-corrected central part of the objective	
Zoom	4.8:1	6.3:1	6.3:1	6.3:1	6.3:1	8:1, apochromatic	
Viewing angle	38°	60°	38°	38°	38°	38°	
ESD protection	antistatic	antistatic	antistatic	Terminator (dissipating)	antistatic	antistatic	
Specific surface resistivity	2×10 ¹¹ Ω/square, discharge time <2 seconds from 1000 V to 100 V	2×10 ¹¹ Ω/square, discharge time <2 seconds from 1000 V to 100 V	2×10 ¹¹ Ω/square, discharge time <2 seconds from 1000 V to 100 V	10 ² –10 ⁶ Ω/square, discharge time <0.1 seconds from 1000 V to zero	2×10 ¹¹ Ω/square, discharge time <2 seconds from 1000 V to 100 V	2×10 ¹¹ Ω/square, discharge time <2 seconds from 1000 V to 100 V	
Magnification (basic configuration)	6.3x–30x	6.3x–40x	6.3x–40x	6.3x–40x	6.3x–40x	10x–80x	
Maximum resolution	372 lp/mm	432 lp/mm	432 lp/mm	432 lp/mm	432 lp/mm	600 lp/mm	
Maximum num. About the Aperture	0.124	0.144	0.144	0.144	0.144	0.2	
Working distance (basic config.)	110 mm	110 mm	110 mm	110 mm	110 mm	75 mm	
Object field diameter	36.5 mm	36.5 mm	36.5 mm	36.5 mm	36.5 mm	23 mm	
Adjustable zoom limits		2	2	2	2	2	
Video/photo outlet, switchable					100 % visual or 100 % video/photo and 100 % visual in the left eyepiece	100 % visual or 100 % video/photo and 100 % visual in the left eyepiece	
Image acquisition, coax lighting.					Yes	Yes	
Standard objectives, lead-free	Achromats 0.32x, 0.5x, 0.63x, 0.75x, 1.6x, 2.0x	Achromats 0.32x, 0.5x, 0.63x, 0.75x, 1.6x, 2.0x	Achromats 0.32x, 0.5x, 0.63x, 0.75x, 1.6x, 2.0x	Achromats 0.32x, 0.5x, 0.63x, 0.75x, 1.6x, 2.0x	Achromats 0.32x, 0.5x, 0.63x, 0.75x, 1.6x, 2.0x	Achromats 0.32x, 0.5x, 0.63x, 0.75x, 1.6x, 2.0x	Apochromats 0.63x, 1.6x, 2.0x Achromat 0.32x
ErgoObjective™	0.6x–0.75x / 77–137 mm 0.7x–1.0x / 48–98 mm	0.6x–0.75x / 77–137 mm 0.7x–1.0x / 48–98 mm	0.6x–0.75x / 77–137 mm 0.7x–1.0x / 48–98 mm	0.6x–0.75x / 77–137 mm 0.7x–1.0x / 48–98 mm	0.6x–0.75x / 77–137 mm 0.7x–1.0x / 48–98 mm	0.6x–0.75x / 77–137 mm 0.7x–1.0x / 48–98 mm	
Adjustable Objectives	0.3x–0.4x / 200–350 mm	0.3x–0.4x / 200–350 mm	0.3x–0.4x / 200–350 mm	0.3x–0.4x / 200–350 mm	0.3x–0.4x / 200–350 mm	0.3x–0.4x / 200–350 mm	
Ergonomic eyepieces, fixed and adjustable, with cups	10x/23, 16x/16, 20x/12	10x/23, 16x/16, 20x/12	10x/23, 16x/16, 20x/12	10x/23, 16x/16, 20x/12	10x/23, 16x/16, 20x/12	10x/23, 16x/16, 20x/12	
Ergonomic eyepieces for eyeglass wearers, adjustable, with eyecups	10x/23, 16x/15, 25x/9.5, 40x/6	10x/23, 16x/15, 25x/9.5, 40x/6	10x/23, 16x/15, 25x/9.5, 40x/6	10x/23, 16x/15, 25x/9.5, 40x/6	10x/23, 16x/15, 25x/9.5, 40x/6	10x/23, 16x/15, 25x/9.5, 40x/6	
Interpupillary distance	55–75 mm	55–75 mm	55–75 mm	55–75 mm	55–75 mm	55–75 mm	



Appendix



Calculating the total magnification/field of view diameter

Parameter

M_O	Magnification of the additional objective
M_E	Magnification of eyepiece
z	Magnification changer position
N_{FOV}	Field number of the eyepiece. Field numbers are printed on the eyepieces: 10×/23, 16×/16, 20×/12, 10×/23B, 16×14B, 25×/9.5B, 40×6B.

Example

M_O	Additional objective 1.6×
M_E	20×/12 eyepiece
z	Zoom position 4.0

Magnification in the binocular tube

$$M_{TOT\ VIS} = M_O \times M_E \times z$$

or

$$1.6 \times 20 \times 4 = 128$$

Calculation example: Field of view diameter in the specimen

$$\varnothing\ OF: \frac{N_{FOV}}{M_O \times z} = \frac{12}{1.6 \times 4} = 1.9\ mm$$



Troubleshooting

The field of view is shadowed

- Adjusting the correct Interpupillary Distance (P. [52](#)).

The image goes out of focus.

- Inserting the eyepieces correctly (P. [55](#)).
- Perform diopter correction exactly according to the instructions (from P. [31](#)).

The focusing drive gradually sinks on its own or is difficult to turn.

- Regulate the ease of movement (P. [30](#)).

In the case of failures of electrically operated devices, always first check:

- Is the voltage selector set correctly?
- Is the main power switch switched on?
- Is the power cable connected correctly?
- Are all connecting cables attached correctly?
- Are the fuses intact?

Photos are blurry.

- Focus accurately (P. [23](#)).
- Bring the reticule into sharp focus and perform diopter correction exactly according to the instructions (P. [37](#)).
- Insert the eyepieces correctly up to the stop (P. [35](#)).
- Check that the graticules are securely in place in the eyepiece (P. [31](#)).

The image from the camera stays black

- Switch the beam splitter on the photo tube to the "Doc" setting (P. [37](#)).



Care, Maintenance, Contact Persons

We hope you enjoy using your stereomicroscope. Leica devices are renowned for their robustness and long service life. Observing the following care and cleaning tips will ensure that even after years and decades, your Leica stereomicroscope will continue to work as well as it did on the very first day.

Warranty benefits

The guarantee covers all faults in materials and manufacture. It does not, however, cover damage resulting from careless or improper handling.

Contact address

However, if your instrument should no longer function properly, contact your technician, your Leica representative or Leica Microsystems (Schweiz) AG, CH-9435 Heerbrugg.

E-mail contact:

stereo.service@leica-microsystems.com

Care

- Protect your stereomicroscope from moisture, fumes and acids and from alkaline, caustic and corrosive materials and keep chemicals away from the instruments.
- Plugs, optical systems and mechanical parts must not be disassembled or replaced, unless doing so is specifically permitted and described in this manual.
- Protect your stereomicroscope from oil and grease.
- Do not grease guide surfaces or mechanical parts.



Care, Maintenance, Contact Persons (continued)

Protection from dirt

Dust and dirt will affect the quality of your results.

- Put a dust cover over the stereomicroscope when it will not be used for a long time.
- Use dust caps to protect tube openings, tubes without eyepieces, and eyepieces.
- Keep accessories in a dust-free place when not in use.

Cleaning polymer components

Some components are made of polymer or are polymer-coated. They are, therefore, pleasant and convenient to handle. The use of unsuitable cleaning agents and techniques can damage polymers.

Permitted measures

- Clean the stereomicroscope (or parts of it) using warm soapy water, then wipe using distilled water.
- For stubborn dirt, you can also use ethanol (industrial alcohol) or isopropanol. When doing so, follow the corresponding safety regulations.
- Remove dust with a pneumatic rubber bulb or with a soft brush.
- Clean objectives and eyepieces with special optic cleaning cloths and with pure alcohol.

The productive cooperative effort "with the user, for the user" has always been the basis for the innovative strength of Leica Microsystems. On this, we have developed our five corporate values:

pioneering, high-end quality, team spirit, dedication to science, and continuous improvement. We call making these values reality **Living up to Life**.

INDUSTRY DIVISION

The Leica Microsystems Industry Division's focus is to support customers' pursuit of the highest quality end result by providing the best and most innovative imaging systems for their needs to see, measure, and analyze microstructures. Its solutions are used in routine and research industrial applications, in materials science and quality control, in forensic science investigations, and educational applications.

Leica Microsystems – an international company with an experienced worldwide customer service network.

Internationally active		Phone	Fax
Australia · North Ryde	+61	2 8870 3500	2 9878 1055
Belgium · Diegem	+32	2 790 98 50	2 790 98 68
Denmark · Ballerup	+45	4454 0101	4454 0111
Germany · Wetzlar	+49	64 41 29 40 00	64 41 29 41 55
England · Milton Keynes	+44	800 298 2344	1908 246312
France · Nanterre Cedex	+33	811 000 664	1 56 05 23 23
Italy · Milan	+39	02 574 861	02 574 03392
Japan · Tokyo	+81	3 5421 2800	3 5421 2896
Canada · Concord/Ontario	+1	800 248 0123	847 405 0164
Korea · Seoul	+82	2 514 65 43	2 514 65 48
The Netherlands · Rijswijk	+31	70 4132 100	70 4132 109
Austria · Vienna	+43	1 486 80 50 0	1 486 80 50 30
Portugal · Lisbon	+351	21 388 9112	21 385 4668
Sweden · Kista	+46	8 625 45 45	8 625 45 10
Switzerland · Heerbrugg	+41	71 726 34 34	71 726 34 44
Singapore	+65	6779 7823	6773 0628
Spain · Barcelona	+34	93 494 95 30	93 494 95 32
USA · Buffalo Grove/Illinois	+1	800 248 0123	847 405 0164
People's Republic of China · Hong Kong	+852	2564 6699	2564 4163
· Shanghai	+86	21 6387 6606	21 6387 6698

10IDS10060EN · Copyright © by Leica Microsystems (Schweiz) AG, CH-9435 Heerbrugg, 2013.
Subject to modifications. LEICA and the Leica Logo are registered trademarks of
Leica Microsystems IR GmbH.

www.leica-microsystems.com

Leica
MICROSYSTEMS