

HAMILTON

U S E R ' S

M A N U A L

MICROLAB[®] 500B/C



The MICROLAB[®] 500 Series:

MICROLAB 510B, 530B, and 540B
and MICROLAB 511C, 531C, and 541C

User's Manual

HAMILTON 
THE MEASURE OF EXCELLENCESM

Part Number 69176 (Rev. D)



Hamilton Company Instrument Warranty

Hamilton Company warrants this equipment (except valves*) to be free of defects in material and workmanship for 12 months from the date of receipt. This warranty is extended to the buyer of record on the original purchase order to Hamilton Company. Hamilton Company or an authorized Hamilton representative agrees to repair or replace, at its option and free of charge to the buyer at a normal place of business or at a Hamilton repair facility, any part or parts that under proper and normal use prove to be defective during the warranty period.** Abuse, unauthorized replacement of parts, modifications, or adjustments made by other than Company or its assigned representatives voids this warranty.

This warranty gives you specific rights. No other warranties, expressed or implied, including implications of warranties of merchantability and fitness for a particular product, are made. Hamilton Company's liability on the sale of all products shall be limited to repair, replacement, or refund of price of any defective product.**

Hamilton Company endeavors to provide prompt and satisfactory service.

*All Hamilton Company valves are warranted to be free of defects in material and workmanship at the time of delivery.

**Hamilton Company reserves the right to refuse to accept the return of any instrument or valve that has been used with radioactive or microbiological substances, or any other material that may be deemed hazardous to employees of Hamilton Company.

© July 1999 by Hamilton Company

GASTIGHT is a registered trademark of Hamilton Company.

MICROLAB is a registered trademark licensed to Hamilton Company.

SANI-CLOTH is a registered trademark of Professional Disposables, Inc.

Instruction to the User

This equipment has been tested and found to comply with the limits for a class B digital device, pursuant to part 15 of the FCC Rules. These limits are designed to provide reasonable protection against harmful interference in an installation. This equipment generates, uses, and can radiate radio frequency energy, and if not installed and used in accordance with the instructions, may cause harmful interference to radio communications. However, there is no guarantee that interference will not occur in a particular installation. If this equipment does cause harmful interference to radio or television reception, which can be determined by turning the equipment off and on, the user is encouraged to try to correct the interference by one or more of the following measures:

- Reorient or relocate the receiving antenna.
- Increase the separation between the equipment and receiver.
- Connect the equipment into an outlet on a circuit different from that to which the receiver is connected.
- Consult the dealer or an experienced radio/TV technician for help.

This equipment has been verified to comply with the limits for a class B computing device, pursuant to FCC Rules. In order to maintain compliance with the FCC regulations, shielded cables must be used with this equipment . Operation with non-approved equipment or unshielded cables is likely to result in interference to radio and TV reception. The user is cautioned that changes and modifications made to the equipment without the approval of the manufacturer could void the user's authority to operate this equipment.

Contents

Figures and Tables	xi
Preface	PR-1
About the MICROLAB 500 Series of Instruments.....	PR-2
Upgrading Your MICROLAB 500 System.....	PR-3
About This Manual	PR-4
Conventions Used in This Manual	PR-5
A Word About Single Syringe Instruments.....	PR-5
Chapter 1 Getting Started	1-1
MICROLAB 500 Parts Lists.....	1-2
A Brief Introduction to the MICROLAB 500B.....	1-8
Drive Unit.....	1-8
Power Cord Connector Receptacle.....	1-13
Hand Probe or Footswitch Connector Receptacle.....	1-13
Fuse Box.....	1-13
Communications Settings.....	1-13
Power On/Off Switch and Power Indicator Light	1-14
Step/Prime Switch	1-14
Valve Assembly	1-15
Syringe Drive Arms.....	1-15
Controller Unit.....	1-16
Pipettors/Probes	1-18
Concorde Push-button Hand Pipettor/Probe.....	1-18
Dual Push-button Hand Pipettor/Probe.....	1-18

	Disposable Tip Push-button Hand Pipettor/Probes.....	1–19
	Luer Lock Tip Push-button Pipette Hand Pipettor/Probe....	1–19
	Viscous Sample Push-button Hand Pipette Pipettor/Probe.....	1–20
	Footswitch.....	1–20
	Probe Button Functions.....	1–20
Chapter 2	Installing the MICROLAB 500 System	2–1
	Overview of Installation Procedures.....	2–3
	Selecting a Location.....	2–3
	Installing the Accessory Holder	2–3
	Selecting Communications Options	2–4
	Installing Electrical Connections.....	2–6
	Installing Valve Assemblies.....	2–8
	Installing the Valve Assembly on the ML 510B/511C.....	2–8
	Installing Valve Assemblies on the ML530B/531C and 540B/541C.....	2–9
	Selecting, Installing, and Removing Syringes.....	2–10
	Preparing Syringes for Installation	2–12
	Installing Syringes.....	2–12
	Removing Syringes.....	2–14
	Selecting and Installing Tubing	2–16
	Selecting Tubing	2–16
	Installing Tubing.....	2–17
Chapter 3	Programming and Using the MICROLAB 500B System.....	3–1
	Using the Controller Unit.....	3–3
	Using the Arrow Keys.....	3–3

Using the Numeric Keypad	3-4
Using the Run/Stop Key.....	3-4
Using the Function Keys	3-4
Editing Conventions	3-5
Powering on the MICROLAB 500.....	3-6
The Main Menu.....	3-7
Priming the MICROLAB 500	3-8
Preparing to Prime	3-8
Using the Prime Function from the Main Menu	3-11
Creating a New Method	3-13
Creating an Aliquot Dispense Method	3-17
Creating a Serial Dispense Method.....	3-18
Creating a Dilution Method.....	3-20
Creating a Pipette Method.....	3-23
Creating a Titrate Method.....	3-25
Creating a Custom Method	3-28
Running an Existing Method.....	3-30
Editing an Existing Method.....	3-32
Performing Manual Dilutions	3-33
Performing Manual Dispenses	3-35
The Utilities Menu	3-37
Renaming an Existing Method	3-38
Deleting an Existing Method.....	3-40
Copying a Method to a Custom Method.....	3-41
Downloading a Method to the Drive unit.....	3-42
Diagnostic and Configuration Menu.....	3-44
Changing the Default Language	3-44

	Setting the Baud Rate to the Drive Unit.....	3-45
	Turning Caps Lock On and Off.....	3-46
	Performing the Display Test.....	3-46
	Performing the Keyboard Test.....	3-46
	Sample MICROLAB 510B Application Configurations.....	3-47
	Single Syringe Dispensing	3-47
	Sample MICROLAB 530B Application Configurations.....	3-48
	Example 1: Dilutions.....	3-48
	Example 2: Dilutions.....	3-49
	Sample MICROLAB 540B Application Configurations.....	3-50
	Example 1: Dual Dispensing	3-50
	Example 2: Using the Dual Dispenser for Single Dispensing.....	3-50
Chapter 4	Caring for the MICROLAB 500.....	4-1
	Deciding When to Clean the MICROLAB 500.....	4-2
	Cleaning the Fluid Path of the MICROLAB 500	4-2
	Cleaning Syringes and Tubing.....	4-3
	Cleaning the Exterior of the MICROLAB 500.....	4-4
	Chemical Compatibility.....	4-5
	Storing the MICROLAB 500.....	4-6
	Replacing Batteries.....	4-6
Chapter 5	Troubleshooting the MICROLAB 500.....	5-1
	Error Message Code Guide.....	5-2
	Audible Messages	5-10
	Troubleshooting Guide	5-11
	Getting Technical Support.....	5-15
	Returning Instruments for Repair.....	5-16

Appendixes

Appendix A	Technical Specifications for the MICROLAB 500.....	A-1
	Pin Outs for RS-232 and TTL Ports	A-3
Appendix B	Instrument Performance Test Reports.....	B-1
Appendix C	Ordering Parts and Accessories for the MICROLAB 500.....	C-1
Appendix D	Chemical Compatibility of the MICROLAB 500.....	D-1
Appendix E	Communication Protocols.....	E-1
	Hamilton Protocol 1/RNO+ Syntax Overview	E-1
	Auto-addressing	E-2
	Data Transfer Format	E-4
	Data String Components	E-5
	DIN Protocol/BDZ+ Syntax.....	E-7
	Hardwire-addressing	E-8
	Auto-addressing	E-8
	Establishing a Data Transfer Session.....	E-9
	Terminating a Data Transfer Session.....	E-10
	Data Transfer Session	E-10
	Data Block Format	E-10
	Data String Components	E-11
	Broadcast Addressing.....	E-16
	Stored Methods.....	E-16
	Stored Method Definition	E-16
	Creating Stored Methods	E-16
	Stored Method Execution	E-17
Appendix F	Protocol Command Summary.....	F-1
	Channel Selection Commands.....	F-2

Initialization Commands	F-3
Syringe Positioning Commands.....	F-4
Valve Positioning Commands	F-5
Timer and Digital I/O Commands.....	F-6
Execution Commands.....	F-7
Instrument Control Commands.....	F-8
Syringe Parameter Change.....	F-9
Valve Parameter Change.....	F-10
Stored Method Parameter Change.....	F-11
Instrument Information Requests	F-11
Instrument Status Requests	F-13
Syringe Parameter Request.....	F-19
Valve Parameter Request.....	F-20
Timer and Digital I/O Requests	F-21
Firmware Version Request.....	F-22
ASCII Chart.....	F-22
ML500B Default Environmental Parameters.....	F-26
ML500B Command Buffer.....	F-26
ML500B Methods.....	F-27
ML500B Specific Protocol Information.....	F-27
Glossary	GL-1
Index	IN-1

Figures and Tables

Preface

Figure PR-1	The MICROLAB 500 Series of Instruments.....	PR-2
-------------	---	------

Chapter 1

Figure 1-1	MICROLAB 500B System Components	1-3
Figure 1-2	MICROLAB 500B Shipping Kit Components	1-5
Figure 1-3	Small Parts Kit.....	1-6
Figure 1-4	Tubing Kit.....	1-7
Figure 1-5	Front View of the ML510B Single Syringe Dispenser	1-9
Figure 1-6	Front View of the ML530B Dual Syringe Diluter... ..	1-10
Figure 1-7	Front View of the ML540B Dual Syringe Dispenser	1-11
Figure 1-8	Rear View of the ML510B, 530B, and 540B.....	1-12
Figure 1-9	The Controller Unit.....	1-17
Figure 1-10	The Concorde, the Disposable Tip, and the Dual Hand Pipettor/Probes.....	1-19
Table 1-1	MICROLAB 500 System Descriptions.....	1-2
Table 1-2	MICROLAB 500B Shipping Kit.....	1-4
Table 1-3	Small Parts Kit #35888 (For All Models).....	1-6
Table 1-4	Tubing Kit #35887 (For All Models)	1-7

Chapter 2

Figure 2-1	Overview of Installation Procedures.....	2-2
Figure 2-2	Installing Electrical Connections.....	2-7
Figure 2-3	Installing a Valve Assembly on the ML510B	2-8

Figure 2–4	Installing a Valve Assembly on the ML530B and 540B.....	2–9
Figure 2–5	The TLL-type Dispenser/Diluent Syringe.....	2–11
Figure 2–6	The TLLX-type Dispenser/Diluent Syringe.....	2–11
Figure 2–7	The DX-type Sample Syringe.....	2–11
Figure 2–8	Installing a Syringe	2–13
Figure 2–9	Removing a Syringe.....	2–15
Figure 2–10	ML510B Valve and Tubing Connections	2–18
Figure 2–11	ML530B Valve with a D Configuration Syringe.....	2–19
Figure 2–12	ML530B Valve with Two TLLX or TLL Syringes ...	2–19
Figure 2–13	ML540B Valve and Tubing Connectors.....	2–20
Figure 2–14	Using the Tubing Reducer with the Dual Hand Probe.....	2–21
Table 2–1	Communications Switches and Ports.....	2–4
Table 2–2	Reagent/Diluent Syringes (TLL and TLLX-types).....	2–10
Table 2–3	Sample Syringes (DX-type).....	2–11
Table 2–4	Tubing Selection Guide.....	2–16

Chapter 3

Figure 3–1	Using the MICROLAB 500B.....	3–1
Figure 3–2	Overview of MICROLAB 500B Functions.....	3–2
Figure 3–3	The Controller Unit.....	3–3
Figure 3–4	Priming the MICROLAB 500	3–10
Figure 3–5	The Utilities Menu	3–37
Figure 3–6	Single Syringe Dispensing	3–47
Figure 3–7	Dilutions.....	3–48
Figure 3–8	Serial Dilutions.....	3–49
Figure 3–9	Dual Dispensing.....	3–50
Figure 3–10	Using the Dual Dispenser for Single Dispensing..	3–51

	Table 3–1	Function Key Actions.....	3–4
Chapter 5			
	Table 5-1	Error Message Code Guide.....	5–2
	Table 5–2	Audible System Messages	5–10
	Table 5–3	Troubleshooting Guide	5–11
Appendix A			
	Table A–1	Technical Specifications for the MICROLAB 500...	A–1
	Table A–2	Accuracy and Precision	A–2
Appendix B			
	Figure B–1	Sample Performance Test Report	B–2
Appendix C			
	Table C–1	Reagent/Diluent Syringe Replacement Parts.....	C–1
	Table C–2	Sample Syringe Replacement Parts	C–2
	Table C–3	Valve Assemblies.....	C–2
	Table C–4	Tubing	C–2
	Table C–5	Pipettors/Probes	C–3
	Table C–6	Parts and Accessories	C–3
Appendix D			
	Table D–1	Chemical Compatibility.....	D–1
Appendix E			
	Table E–1	Protocol 1/RNO+ Control Characters.....	E–2
	Table E–2	DIN Protocol/BDZ+ Control Characters	E–8
Appendix F			
	Table F-1	Channel Selection Commands.....	F–2
	Table F-2	Initialization Commands	F-3
	Table F-3	Syringe Positioning Commands.....	F-4

Table F-4	Valve Positioning Commands	F-5
Table F-5	Timer and Digital I/O Commands	F-6
Table F-6	Execution Commands	F-7
Table F-7	Instrument Control Commands.....	F-8
Table F-8	Syringe Parameter Change.....	F-9
Table F-9	Valve Parameter Change	F-10
Table F-10	Stored Method Parameter Change.....	F-11
Table F-11	Instrument Information Requests	F-11
Table F-12	Instrument Status Request.....	F-13
Table F-13	Syringe Parameter Request.....	F-19
Table F-14	Valve Parameter Request	F-20
Table F-15	Timer and Digital I/O Requests	F-21
Table F-16	Firmware Version Request.....	F-22
Table F-17	ASCII Chart.....	F-23

Welcome to the World of Hamilton Precision Instruments

Congratulations on your purchase of a Hamilton MICROLAB 500 system. The Hamilton MICROLAB 500 is a versatile, semi-automatic, precision liquid processor. Various models of the MICROLAB 500 function as either single- or dual-syringe diluter/dispensers.

The MICROLAB 500 functions on the principal of liquid/liquid displacement. At the heart of each MICROLAB 500 system is a highly efficient, precision stepper motor drive that is combined with world-famous Hamilton GASTIGHT syringes. The result is a precise and accurate instrument that is very easy to set up and use.

With proper care and maintenance, your new MICROLAB 500 system will serve you faithfully. To learn about the proper care and maintenance of your investment, please take the time to read this manual. Also, please read the warranty information that appears on the copyright page in this manual and on the separate warranty sheet that is included in your MICROLAB 500 shipping kit.

The Hamilton Company thanks you for purchasing this Hamilton product. Welcome to the world of Hamilton precision instruments!

About the MICROLAB 500 Series of Instruments

All of the MICROLAB 500 systems feature four common pipette modes: fill, dispense, auto-refill, and prime. The systems are capable of performing accurate and precise transfer pipetting, and of performing automated dilutions up to 1:25,000. The instruments can also dispense up to 50 mL per cycle. Figure PR-1 provides an overview of the MICROLAB 500 Series of Instruments.

Figure PR-1 The MICROLAB 500 Series of Instruments

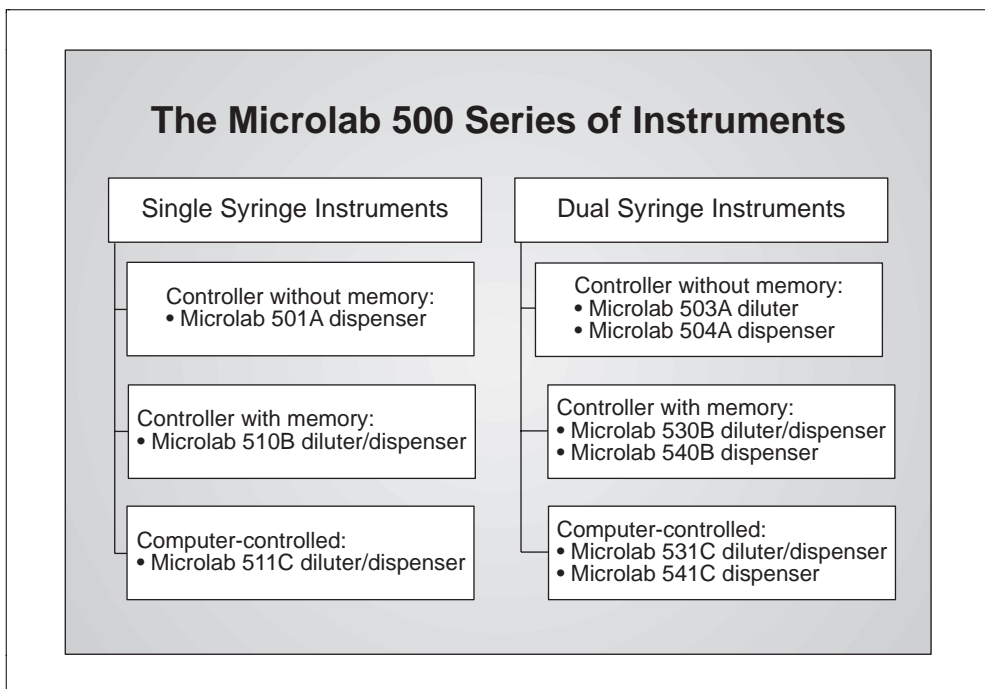

The MICROLAB 500 Series of instruments consists of three different lines of diluter/dispensers.

- **Controller without memory:** Use the controller unit to manually enter methods. This controller unit does not have memory, so methods cannot be stored.
- **Controller with memory:** This controller unit has memory, allowing you to program and store your own custom methods. Or, use the controller unit to run manual methods. Any instrument that uses this controller can also be computer controlled.
- **Computer controlled:** No controller unit is included; use a computer to operate the instrument.

The MICROLAB 510B/511C, 530B/531C, and 540B/541C are described in this manual.

- The **MICROLAB 510B/511C** is a single syringe dispenser designed for single precision dispensing applications.
- The **MICROLAB 530B/531C** is a dual syringe diluter designed for repetitive dilution applications.
- The **MICROLAB 540B/541C** is a dual syringe dispenser designed for precision dispensing applications that require more than one liquid to be dispensed at a time.

Upgrading Your MICROLAB 500 System

Both the MICROLAB 510B/511C and 530B/531C systems can be upgraded to MICROLAB 540B/541C systems. For upgrade information or for information about purchasing any of the MICROLAB 500 models, contact your authorized Hamilton sales representative or contact Hamilton Company.

In the United States:

Hamilton Company, P.O. Box 10030, Reno, Nevada 89520-0012

Telephone Numbers (in the USA and Canada):

Technical/Customer Service 1-800-648-5950 8 a.m. to 5 p.m. PST

Instrument Service 1-800-527-5269

Outside the USA and Canada:

Fax Number: +1-775-858-3000
+1-775-856-7259

In Switzerland:

Hamilton Bonaduz AG, Ch-7402, P.O. Box 26,
Bonaduz, Switzerland
Telephone Number: +41-81-660-60-60
Fax Number: +41-81-660-60-70

About This Manual

This manual provides technical information about the MICROLAB 510B/511C, 530B/531C, and 540B/541C, and is divided into chapters that cover the following topics:

- Chapter 1, Getting Started, provides an overview of the MICROLAB 500 system, including a complete parts list and a brief description of the system components.
- Chapter 2, Installing the MICROLAB 500, describes how to set up the system.
- Chapter 3, Using the MICROLAB 500, provides step-by-step instructions for using the system. It also provides sample applications.
- Chapter 4, Caring for the MICROLAB 500, describes everyday maintenance techniques.
- Chapter 5, Troubleshooting, contains tables that list system messages and their meanings, and common problems and their solutions.
- The Appendixes provide detailed information, such as technical specifications, ordering information, etc.
- The Glossary defines terms used in this manual.
- The Index provides a quick-reference to the topics described in this manual.

Conventions Used in This Manual

Throughout this manual symbols are used to call your attention to various kinds of information.



Warning! Information that is essential for avoiding personal injury is flagged with the International Warning Symbol and appears like this in the text. 

▲ Important Information that is essential for avoiding damage to equipment appears like this in the text. **▲**

★ Note: Interesting information or information that can help improve system performance appears like this in the text. **★**

System messages and prompts that appear on the controller unit's display screen are shown in `courier` font. Items that are selected and user input appear in **`boldface courier`**.

A Word About Single Syringe Instruments

Throughout this manual you will see references to multiple syringes, volumes, speeds, and to the right-side controls. All screen examples show the use of dual syringe instruments. If you are using a MICROLAB 510B/511C single syringe dispenser, please disregard these references. The right-side functions are not available on single syringe instruments.

Any operational differences between the single and the dual syringe instruments are called out in the text.

Chapter 1 Getting Started

This chapter provides a brief overview of the MICROLAB 500 system. Information in this chapter includes:

- MICROLAB 500 parts lists
- MICROLAB 500 components
 - the drive unit
 - the controller unit
 - hand pipettors/probes

All MICROLAB 500 instruments come with everything you need to start using the system, with the exception of syringes. You must separately purchase syringes for use with the MICROLAB 500 systems. For complete lists of syringes, accessories, and replacement parts for the MICROLAB 500, see Appendix C, Ordering Parts and Accessories for the MICROLAB 500.

★ Note: Contact your local delivery company if you notice any visual damage to the MICROLAB 500 shipping package or to its contents. Also, you may want to save the shipping container in case you ever need to return the instrument for service. ★

MICROLAB 500 Parts Lists

This section includes complete parts lists for the MICROLAB 500 systems. After you unpack your MICROLAB 500, check to see that you have received all parts before attempting to set up the system. The parts lists are presented in four separate tables with four corresponding figures.

Table 1-1 lists the programmable models in the MICROLAB 500 series, their components, and each component's part number. Figure 1-1 shows these components.

Table 1-1 MICROLAB 500 System Descriptions

Model*	Part #	Drive Unit Part #	Controller Unit & Cord Part #	Manual Part #	Power Cord	Shipping Kit Part #
MICROLAB 510B 115V	ML510115	35890	35893	69176 (English) 69182 (French) 69180 (German) 69186 (Portuguese) 69188 (Spanish)	6541000	35792
MICROLAB 510B 220V	ML510220	35890	35893	same as above	355010	35792
MICROLAB 530B 115V	ML530115	35891	35893	same as above	6541000	35793
MICROLAB 530B 220V	ML530220	35891	35893	same as above	355010	35793
MICROLAB 540B 115V	ML540115	35892	35893	same as above	6541000	35794
MICROLAB 540B 220V	ML540220	35892	35893	same as above	355010	35794

* All MICROLAB 500C models come with the drive unit, the manual, a power cord, and a valve. The MICROLAB 500 C does not come with a controller or a shipping kit.

Figure 1-1 MICROLAB 500 System Components (items shown are not to scale)

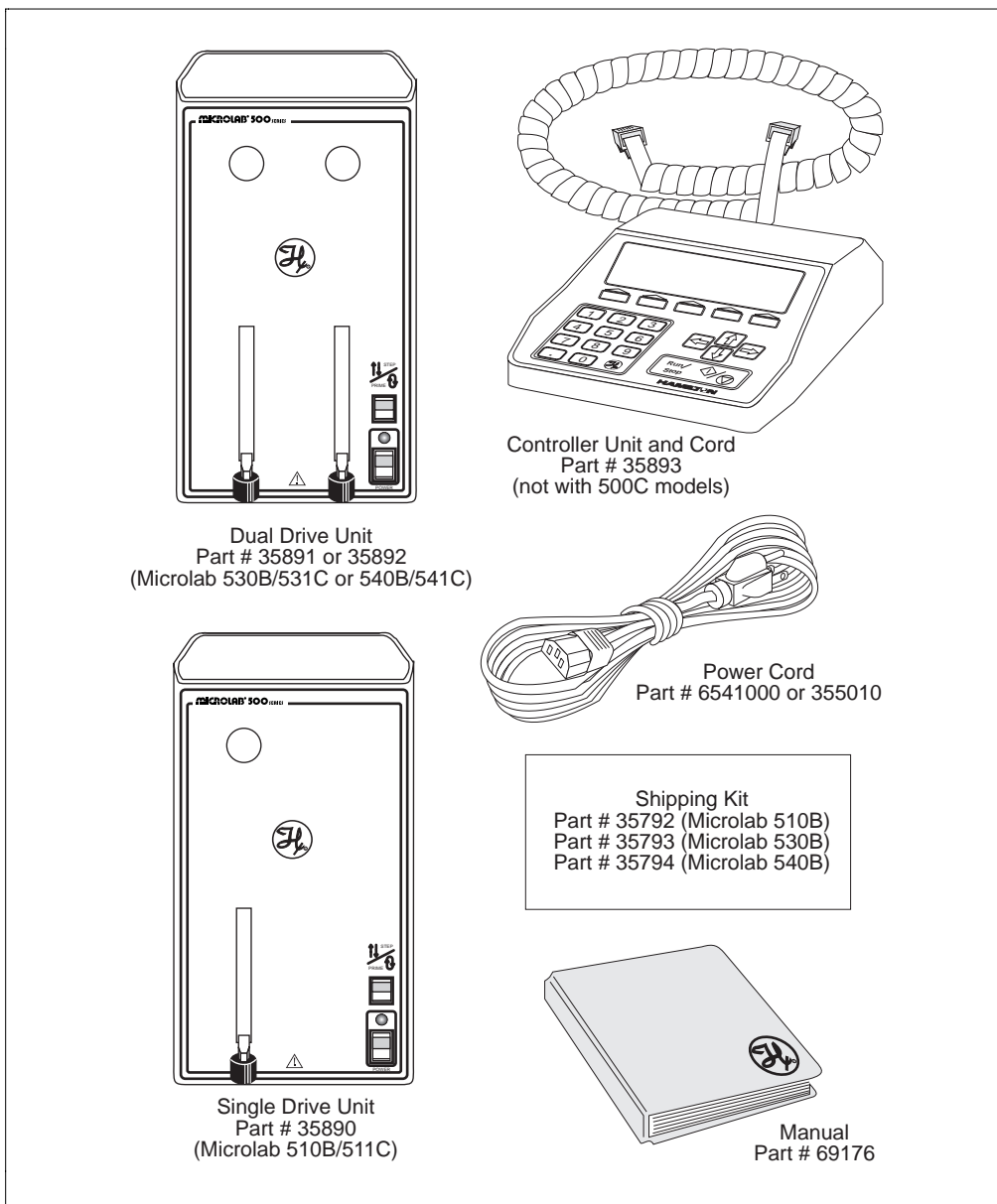

Table 1-2 lists the components that make up the MICROLAB 500B Shipping Kit (shown as a box in Figure 1-1). Figure 1-2 shows these components.

Table 1-2 MICROLAB 500B Shipping Kit

Shipping Kit* Part #	Valve Part #	Hand Probe Part #	Small Parts Kit Part #	Tubing Kit Part #
MICROLAB 510B 35792	HV Valve 35825	Concorde Probe 35529	35888	35887
MICROLAB 530B 35793	Diluter Valve 35844	Concorde Probe 35529	35888	35887
MICROLAB 540B 35794	Dispenser Valve 35842	Dual Hand Probe 35767	35888	35887 2 items

**The MICROLAB 500C is standard with only the valve. All other parts must be ordered separately.*

Figure 1-2 MICROLAB 500B Shipping Kit Components (items shown are not to scale)

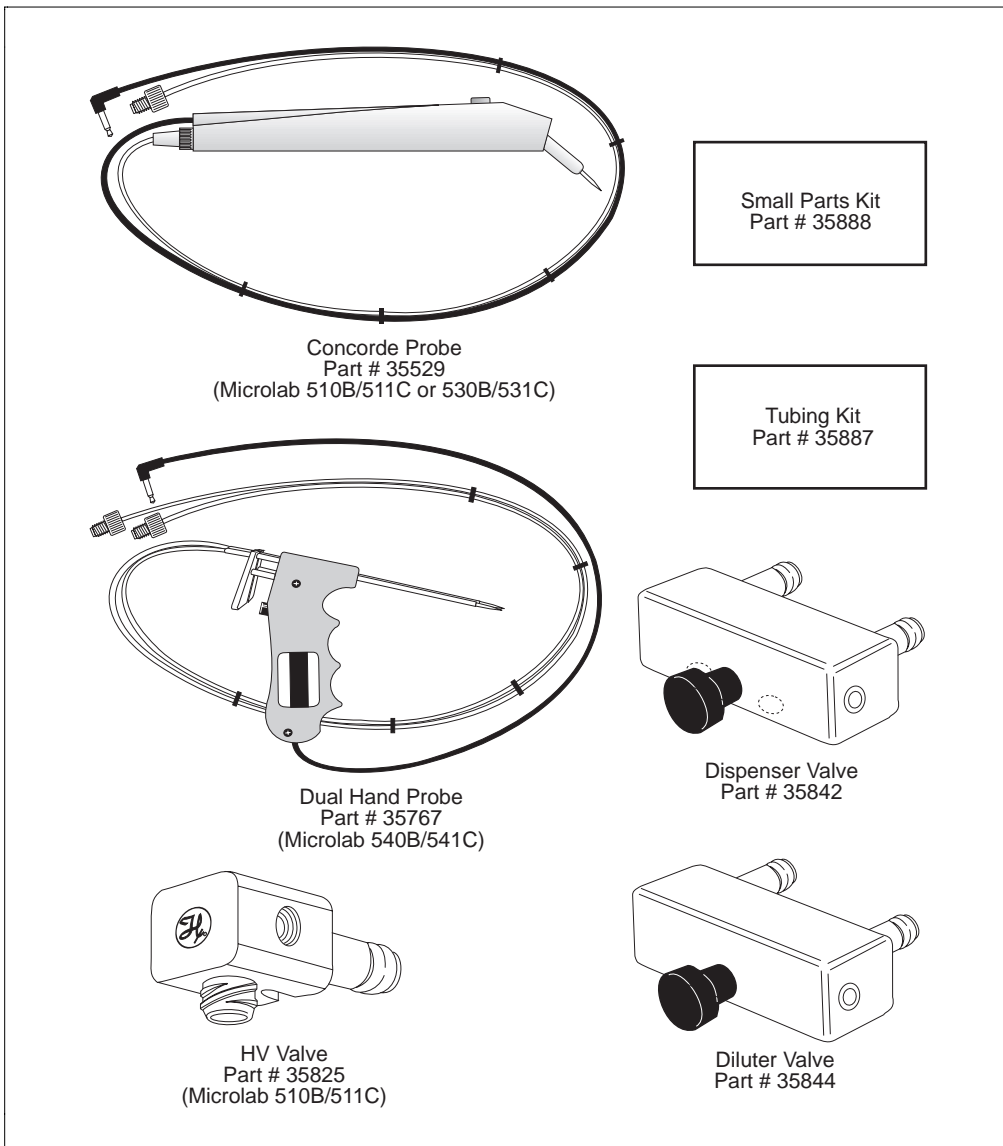

Table 1-3 lists the components that make up the MICROLAB 500B Small Parts Kit (shown as a box in Figure 1-2). Figure 1-3 shows these components.

Table 1-3 Small Parts Kit #35888 (For All 500B Models)

Tubing Clips Part #	1 AMP Fuses Part #	Accessory Holder Part #	Screws Part #	Tubing Reducers Part #
230010 2 items	1524-01 2 items	35783 1 item	16500 2 items	35770 2 items

Figure 1-3 Small Parts Kit (items shown are not to scale)

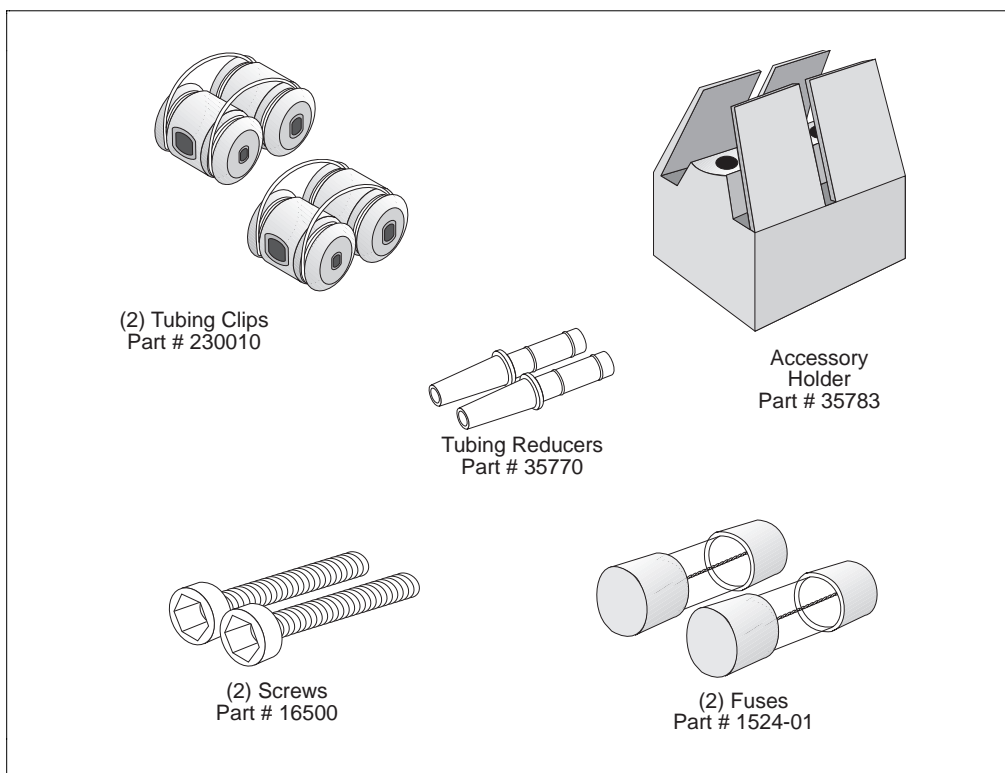

Table 1-4 lists the components that make up the MICROLAB 500 Tubing Kit (shown as a box in Figure 1-2). Figure 1-4 shows these components.

Table 1-4 Tubing Kit #35887 (For All 500B Models)

12 ga. x 650 mm Fill Tubing (not tapered) Part #	18 ga. x 650 mm Fill Tubing (not tapered) Part #	12 ga. x 900 mm Dispense Tubing (tapered) Part #	18 ga. x 900 mm Dispense Tubing (tapered) Part #
240000*	240010*	240360*	240130*

* M6 threaded hubs are used on all tubing.

Figure 1-4 Tubing Kit (items shown are not to scale)

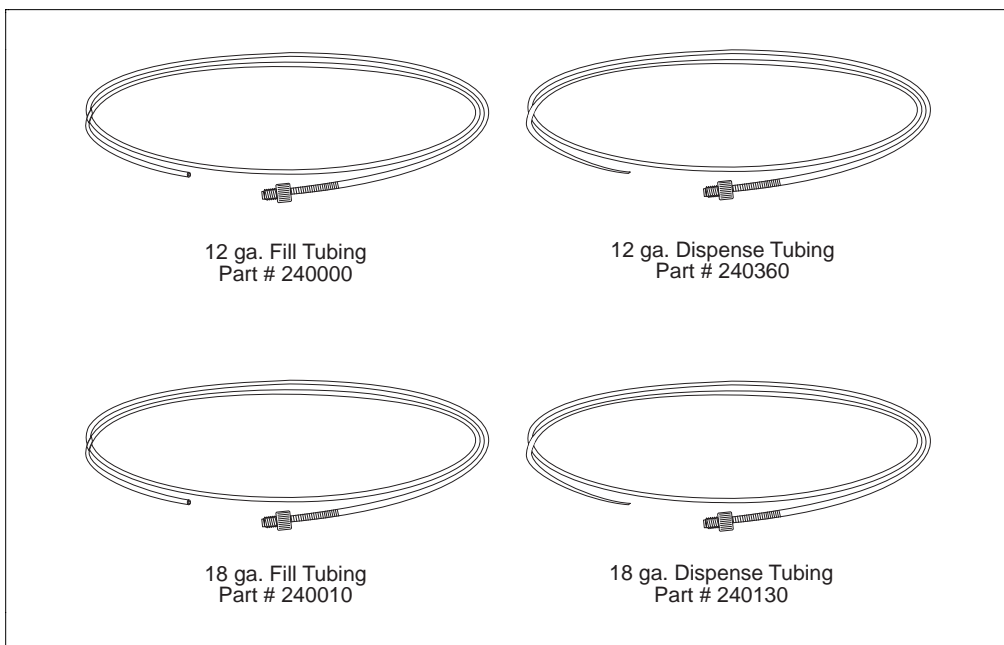

For complete lists of syringes, accessories, and replacement parts for the MICROLAB 500, see Appendix C, Ordering Parts and Accessories for the MICROLAB 500.

A Brief Introduction to the MICROLAB 500B

The MICROLAB 510B, 530B, and 540B systems each consist of three basic units. These units include:

- a drive unit
- a controller unit
- a hand probe

This section briefly describes these units and the individual components that comprise each unit. See Chapter 2, *Installing the MICROLAB 500*, for complete installation instructions; see Chapter 3, *Using the MICROLAB 500*, for complete usage instructions.

Drive Unit

The drive unit is the heart of each MICROLAB 500 system. The drive unit contains a precision drive motor, the syringe drive arms, the valve assembly, the power switches, and the connector receptacles. These features allow you to control other sub-assemblies, and together they create a very versatile and functional instrument.

Figure 1– 5 shows the front view of the MICROLAB 510B single syringe diluter/dispenser. In this figure, the controller unit rests on top of the drive unit and a syringe is attached to the syringe drive arm.



Warning! This warning label appears on the front panel of the ML500. It indicates that a pinch hazard exists when the syringe drive is moving. 

Figure 1-5 Front View of the MICROLAB 510B Single Syringe Diluter/Dispenser

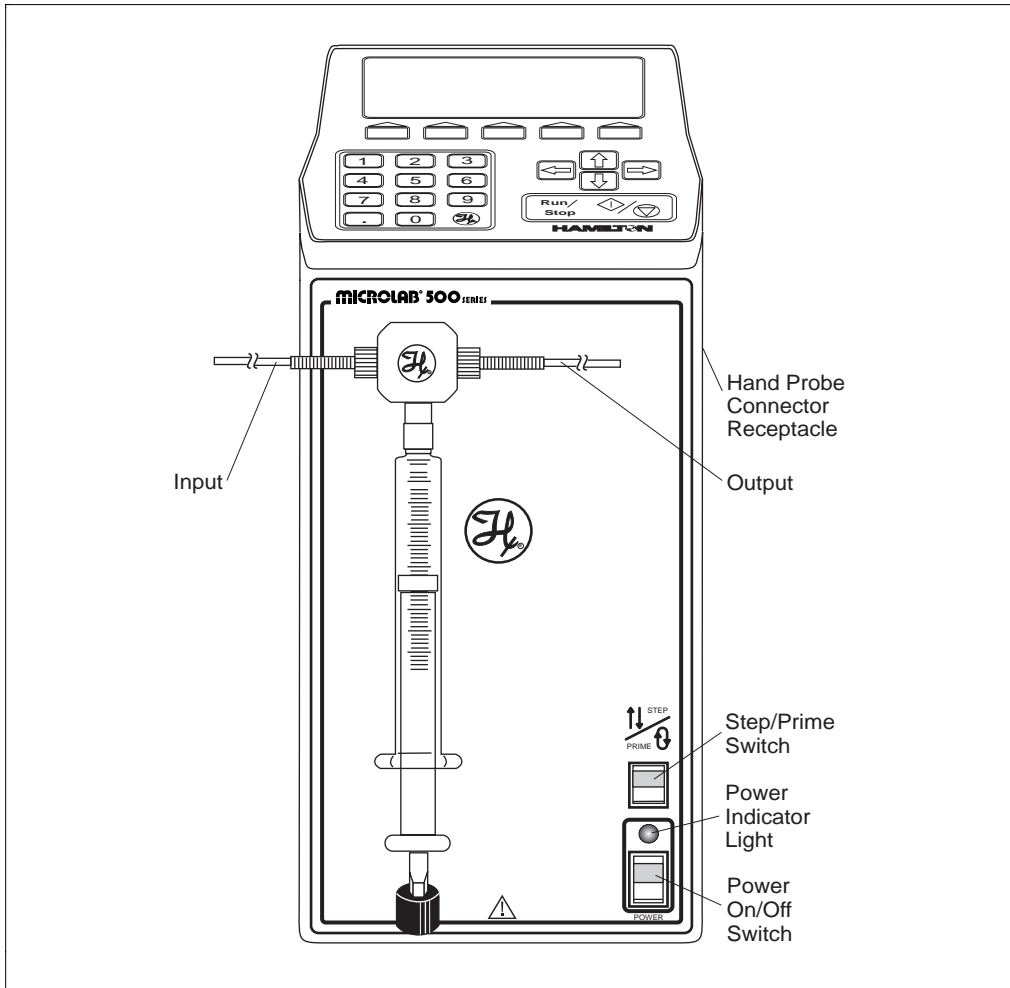

Figure 1-6 shows the front view of the MICROLAB 530B dual syringe diluter. In this figure, the controller unit rests on top of the drive unit and syringes are attached to the syringe drive arms.

Figure 1-6 Front View of the MICROLAB 530B Dual Syringe Diluter

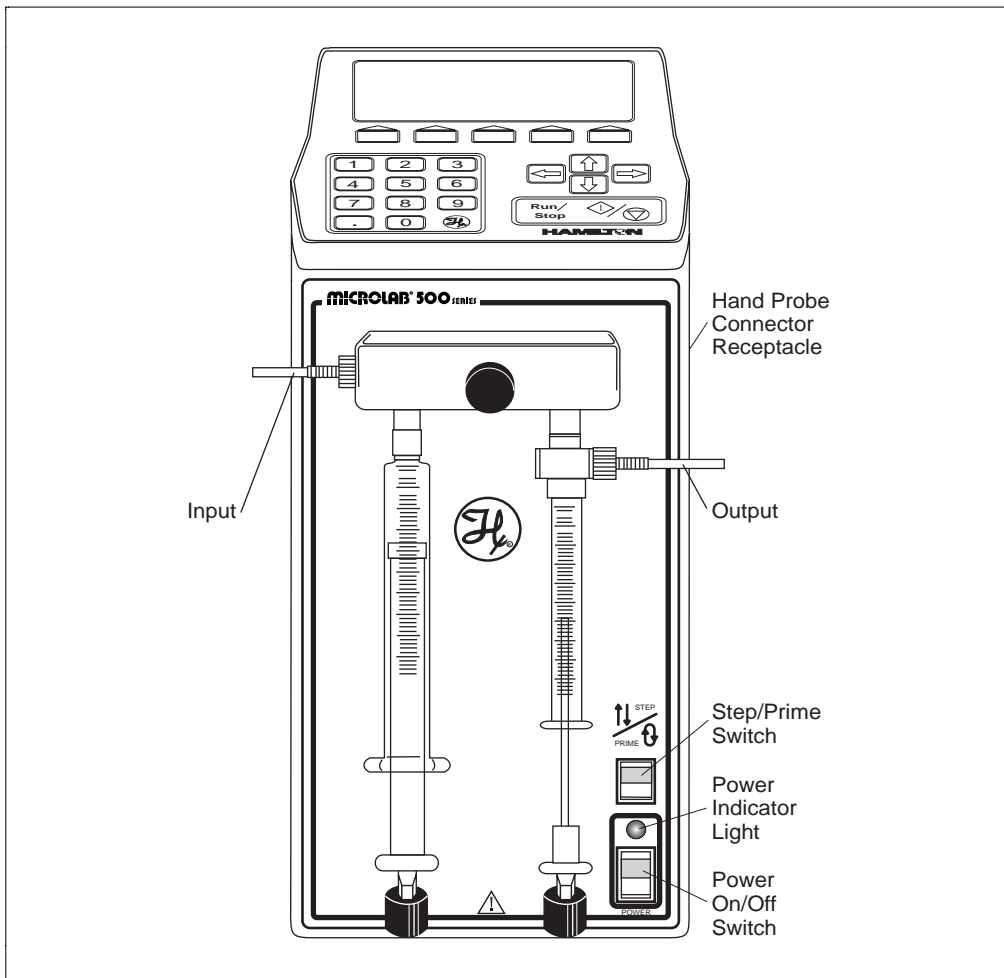

Figure 1-7 shows the front view of the MICROLAB 540B dual syringe dispenser. In this figure, the controller unit rests on top of the drive unit and syringes are attached to the syringe drive arms.

Figure 1-7 Front View of the MICROLAB 540B Dual Syringe Dispenser

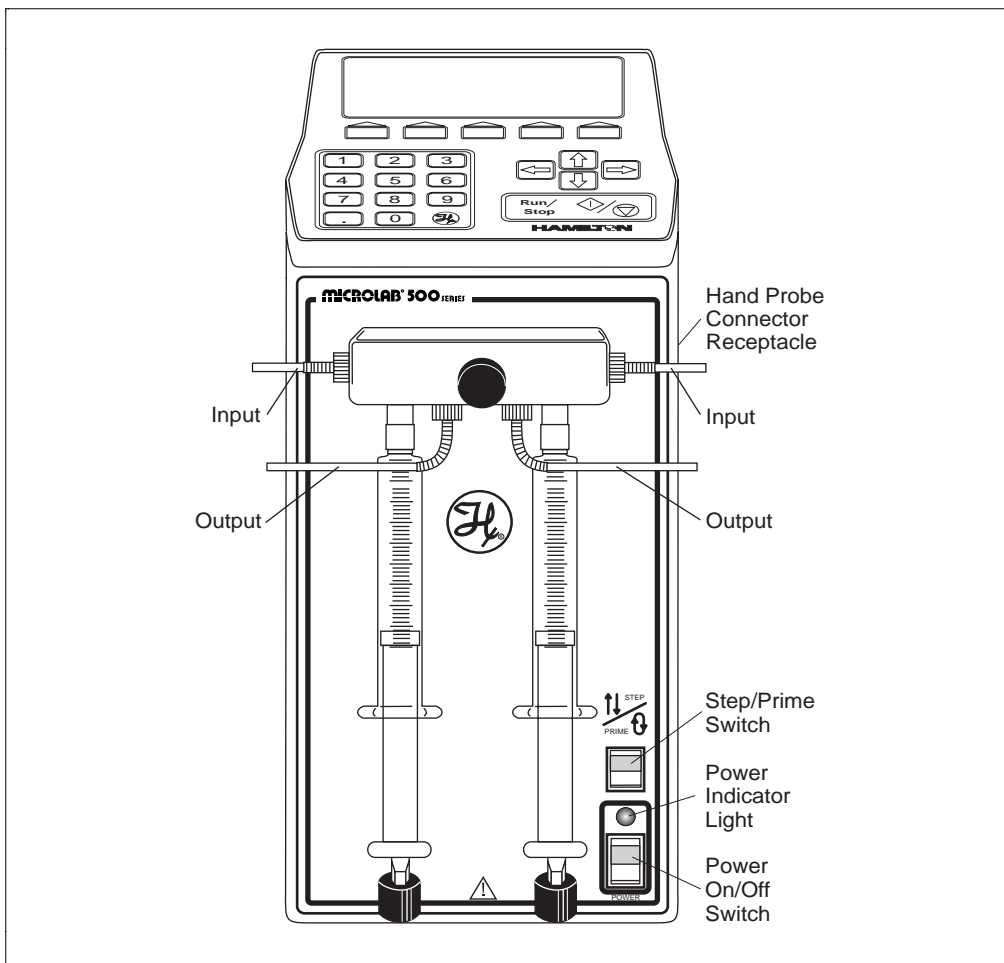
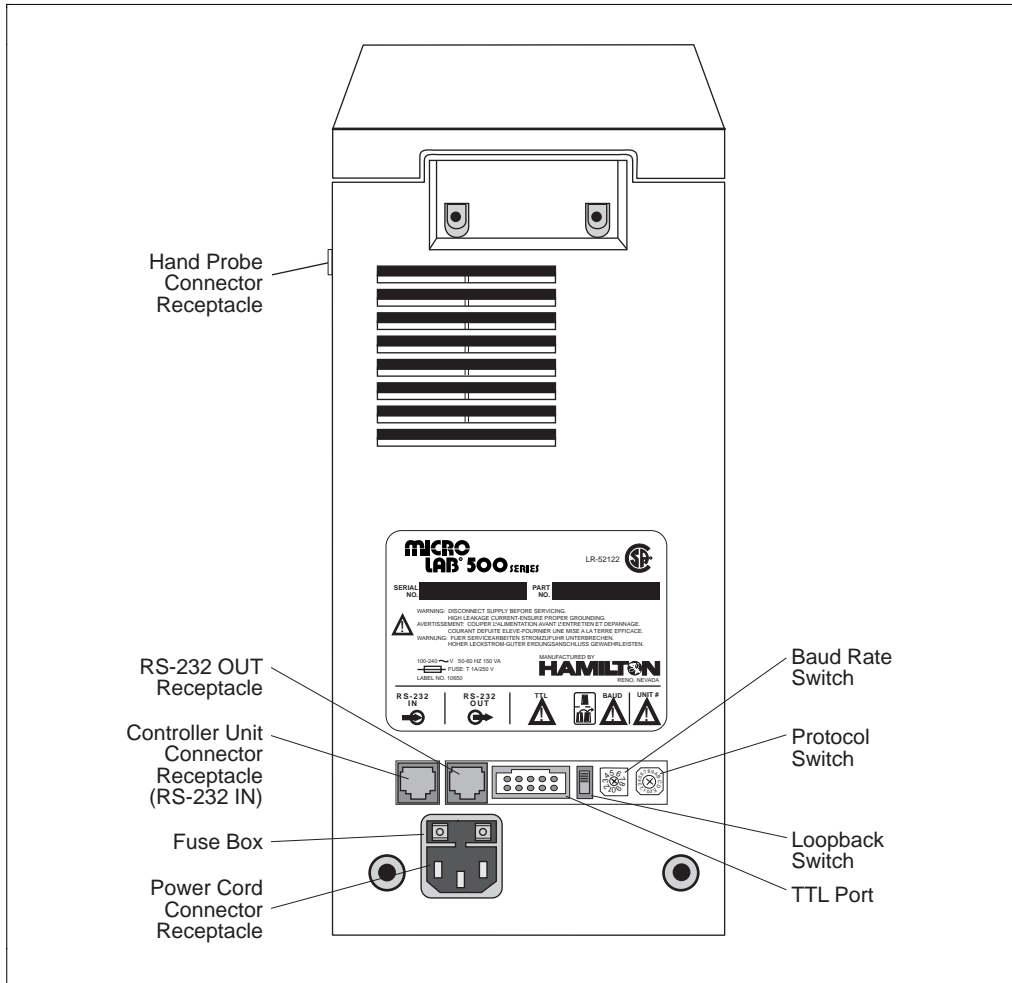

Figure 1-8 shows the rear view of all units.

Figure 1-8 Rear View of the MICROLAB 500.



Power Cord Connector Receptacle

The power cord connector receptacle is located on the back of the drive unit; the power cord fits into this receptacle only one way. The receptacle accepts cords for either 115V or 220V without any adaptation of the drive unit. See Figure 1-8 for the location of the power cord connector receptacle.

Hand Probe or Footswitch Connector Receptacle

The hand probe connector receptacle is located on the upper right side of the drive unit. You can insert either a hand probe jack or a footswitch jack into this receptacle. See Figures 1-5 through 1-8 for the location of the hand probe connector receptacle.

Fuse Box

The fuse box is located at the top of the power cord connector receptacle. To gain access to the fuse box, you must first remove the power cord. See Figure 1-8 for the location of the fuse box.

Communications Settings

All communications switches and ports are located on the back of the drive unit beneath the serial number label. These items are listed here; refer to “Selecting Communications Options” in Chapter 2 for complete information about setting and using these receptacles and switches.

- The RS/232 IN receptacle handles incoming communications.
- The RS/232 OUT receptacle handles outgoing communications.
- The TTL port allows peripheral devices to attach to the drive unit.
- The Loopback switch allows the drive unit to daisy-chain to other units.
- The Baud Rate switch controls the speed at which the drive unit communicates with other devices.
- The Protocol switch determines the hardware address and protocol of the drive unit.

Power On/Off Switch and Power Indicator Light

The Power On/Off switch and the Power Indicator light are located on the front of the drive unit in the lower right-hand corner. See Figures 1-5 through 1-7 for the locations of the switch and the indicator light.

The Power On/Off switch is a two-position rocker switch.

- To power-on the MICROLAB 500, press the upper half of the switch. The system beeps twice when it is powered on.
- To power-off the MICROLAB 500, press the lower half of the switch.

The Power Indicator light is a small green LED located directly above the Power On/Off switch. It is lit when the unit is powered on.

Step/Prime Switch



The Step/Prime switch is located on the front of the drive unit in the lower right-hand corner, directly above the power indicator light. See Figures 1-5 through 1-7.

The Step/Prime switch is a three-position rocker switch.

- When the Step/Prime switch is in the middle position, the switch is inactive.



- When you press the lower part of the Step/Prime switch, the ML500 goes into prime mode. When in prime mode, the syringe drive arms automatically move up and down, opening the valve ports, and moving fluid through the system. The ML500 stays in prime mode until you press the upper or the middle part of the Step/Prime switch. The syringe will return to home position.



- When you press the upper part of the Step/Prime switch, the ML500 goes into Step mode. When in Step mode, the drive arms move only as long as you press the Step/Prime switch. When you release the switch, movement stops.

Use the Step mode to move the syringe drive arm down and away from the home position before installing or removing syringes.

Valve Assembly

The valve assembly controls the flow of liquid through the fluid path. The 510B/511C, 530B/531C, and 540B/541C models each use a different valve assembly; you must attach the assembly to the drive unit. See Figures 1–5 through 1–7 for the location of the valve assembly. See “Installing the Valve Assembly” in Chapter 2 for installation instructions.

Syringe Drive Arms

You attach syringes to the MICROLAB’s syringe drive arms. The syringe drive arms are engineered to drive Hamilton precision syringes with high-resolution stepper motors; the motors and drive arms are connected by a precision lead screw. See “Selecting, Installing, and Removing Syringes” in Chapter 2 for syringe installation instructions.

Controller Unit (for MICROLAB 500B Models)

The controller unit is a portable device that connects to the syringe drive unit via the controller connector cord. Use the controller unit to program and store methods and send information and instructions to the drive unit. For ease of use and for everyday storage, the controller unit fits on top of the drive unit. Figure 1-9 shows the controller unit.

The display screen and controls are located on the unit:

- **display screen**—The display screen is located at the top of the unit. It shows the status of the instrument and provides information about current methods.
- **function keys**—The function keys are located directly beneath the display screen. Use these keys to perform the various operations shown on the display screen.
- **numeric keypad**—The numeric keypad is located in the lower left corner of the controller unit. Use the numeric keypad characters to enter numeric data into the methods that you create or run.
- **arrow keys**—The arrow keys are located on the right side of the controller unit. Use these keys to move from field to field on the display screen.
- **Run/Stop key**—The Run/Stop key is located in the bottom right corner of the controller unit. This key generates a command signal that activates the next step of an operation.

See Chapter 3, Programming and Using the MICROLAB 500 System, for complete instructions about using the controller unit's various keys.

*** Note: 500C models may be operated with the controller unit; However, the controller is not included in the standard 500C package. ***

Figure 1-9 The Controller Unit

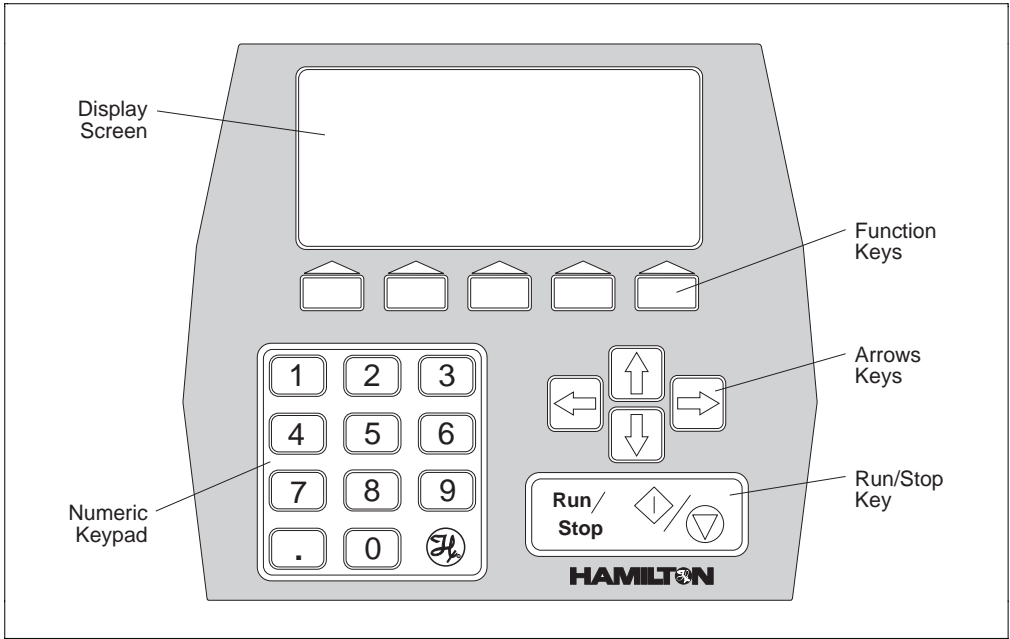

Pipettors/Probes

Each MICROLAB 500B system comes with a remote push-button, hand-held pipettor/probe. The standard accessory probes include:

- the Concorde Push-button Hand Pipettor/Probe (ships with MICROLAB 510B and 530B; must be ordered separately for 500C models)
- the Dual Push-button Hand Pipettor/Probe (ships with MICROLAB 540B; must order separately for the 541C model)

Additionally, three other optional probes may be ordered separately for use with any MICROLAB 500 system. These probes include:

- the Disposable Tip Push-button Hand Pipettor/Probe
- the Luer Lock Tip Push-button Pipette Hand Pipettor/Probe
- the Viscous Sample Push-button Hand Pipettor/Probe

Concorde Push-button Hand Pipettor/Probe

The Concorde Push-button Hand Pipettor/Probe is a single-dispense pipette probe that features a slim, comfortable design. Use this probe with MICROLAB 501 and 503 systems. The Concorde probe attaches directly to a sampling syringe or to the valve assembly (output port). This probe accommodates both 12- or 18-gauge tubing and features adjustable extension lengths beyond the probe tip. See Figure 1–10.

Dual Push-button Hand Pipettor/Probe

The Dual Push-button Hand Pipette Probe is a dual-dispense pipette that features a pistol grip design with push-button actuator. Use this probe with MICROLAB 504 systems. This probe accommodates both 12- and 18-gauge tapered tubing lines with independent extensions. You can extend the tubing out the end of the probe to the length that is convenient for your application; either the right-side or the left-side tubing can be extended to pick up sample. Figure 1–10 shows the Dual Push-button Hand Pipette Probe.

Disposable Tip Push-button Hand Pipettor/Probes

The Disposable Tip Push-button Hand Pipette Probe is a single-dispense tube pipette that features disposable tips and push-button tip ejection. The Disposable Tip Push-button Hand Pipette Pipettor/Probe is an optional accessory. Use this probe when sample-to-sample carryover is a concern. See Figure 1–10.

Figure 1–10 shows the Concorde, the Disposable Tip, and the Dual Hand Pipettor/Probe.

Figure 1–10 The Concorde, the Disposable Tip, and the Dual Hand Pipettor/Probes

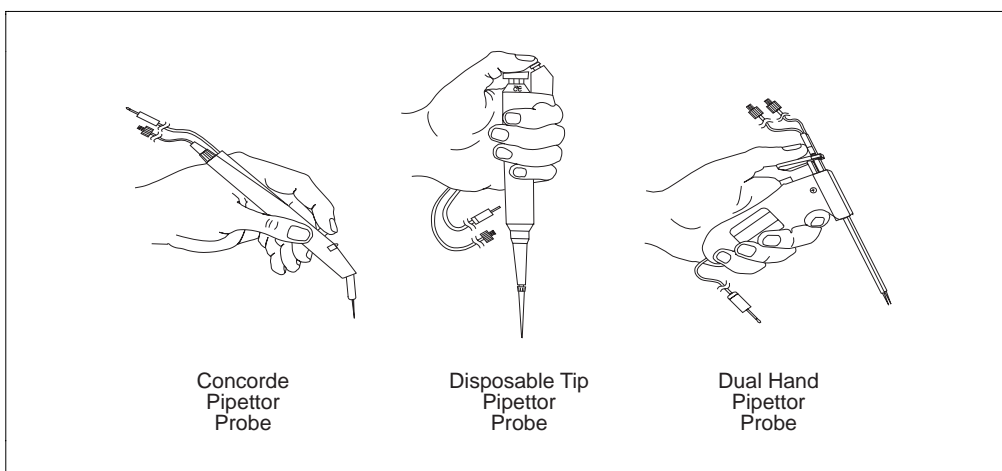

Luer Lock Tip Push-button Pipette Hand Pipettor/Probe

The Luer Lock Tip Push-button Pipette Hand Pipettor/Probe is an optional accessory that dispenses liquids through needles of different lengths and gauges. This probe is useful for controlling very small dispense volumes with a high degree of accuracy. It is also ideal for administering injections to small animals and for piercing septa.

Viscous Sample Push-button Hand Pipette Pipettor/Probe

The Viscous Sample Push-button Hand Pipettor/Probe is an optional accessory. This single-dispense tube pipette is designed to accommodate highly viscous samples, such as motor oil. This accessory features a disposable 5 mL tip that eliminates sample carryover. Air displacement ensures accurate dilutions.

Footswitch

In addition to the hand-activated probes, a footswitch is also available. The footswitch allows you to operate the MICROLAB 500 via a foot-activated control pedal. This is useful when you need to keep both hands free, as when doing hand-sampling.

Refer to Appendix C for information about ordering the footswitch or any other optional accessories.

Probe Button Functions

The probe button (on any model of hand probe) serves basically the same function as the Run/Stop key on the controller unit. However, you cannot use the probe button to pause an operation or to reinitialize the system after an error occurs.

Chapter 2 Installing the MICROLAB 500 System

This chapter contains information about installing the MICROLAB 500 system, including the following topics:

- an overview of installation procedures
- selecting an installation location
- installing the accessory holder
- determining communications settings
- installing electrical connections
- installing the valve assembly
- selecting, installing, and removing syringes
- selecting and installing tubing

▲ Important Be sure to read the instructions in this chapter before installing your MICROLAB system.

- **Never install or use syringes incorrectly. Incorrect use may result in damage to the syringes. See “Selecting, Installing, and Removing Syringes” later in this chapter for more information.**
- **Never over-tighten tubing. Over-tightening may result in damage to the valves or tubing. See “Selecting and Installing Tubing” later in this chapter for more information.**
- **Call Hamilton Company’s Technical/Customer Service Department at (800) 648–5950 (in the United States and Canada) if you have questions about installing your MICROLAB 500 system. ▲**

Figure 2-1 Overview of Installation Procedures

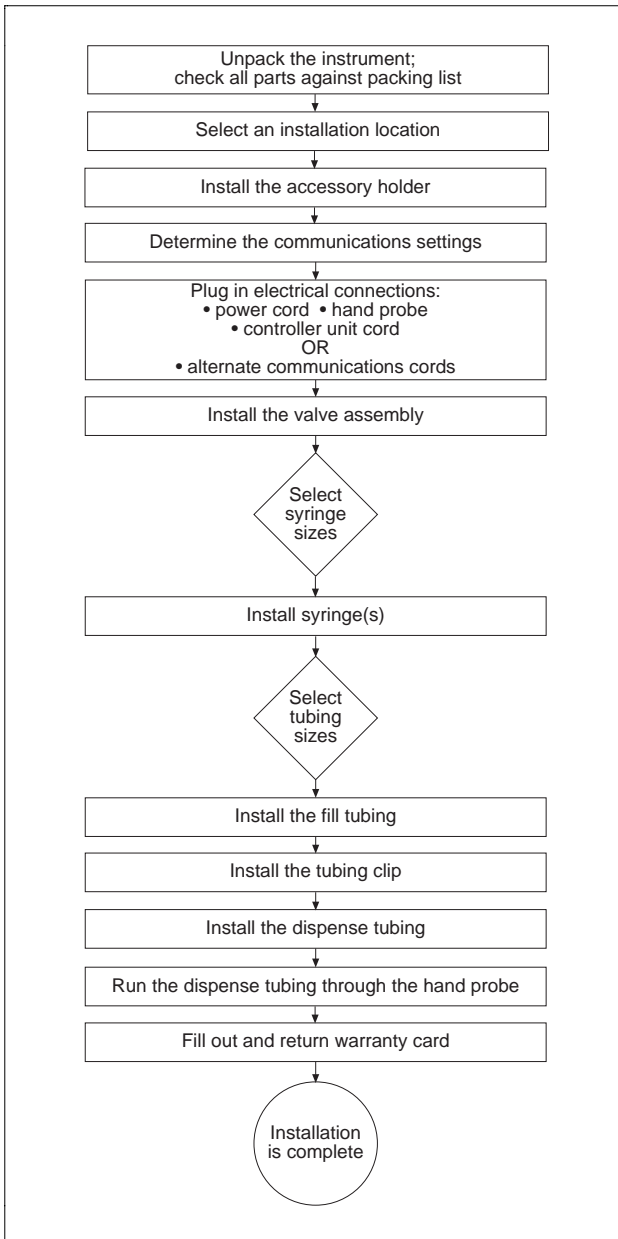

Overview of Installation Procedures

Figure 2-1 provides an overview of the MICROLAB 500B installation procedures. These procedures are described in detail in this chapter.

Selecting a Location

Install your MICROLAB 500 system in a clean, dry, level area away from hazardous fumes. Leave space around the unit for ventilation; three inches is sufficient.

Installing the Accessory Holder

All MICROLAB systems come with an accessory holder. You can mount the accessory holder on either the right or the left side of the instrument. Generally, the accessory holder is mounted on the right side and is used to hold a hand probe when the probe is not in use. To install the accessory holder, follow these steps:

1. Locate the threaded holes on either the right or the left side of the instrument.
2. Use a hex wrench and screws (screws are provided) to attach the holder.

Selecting Communications Options

To select communications options, you must first decide how you will use the instrument. That is, will it be used as a standalone device or will it be on a daisy chain? Based on its use, select the appropriate communications settings. See Figure 2-2 for the location of the communication switches and ports. Table 2-1 describes the purposes of these switches and ports.

To change a switch's position, power the instrument off. Then use a screwdriver to change the switch position. The small bump on the switch indicates the selected position. After you change a switch's position, power the instrument back on again.

Table 2-1 Communications Switches and Ports





Icon	Item	Purpose	Possible Settings and Uses
	RS-232 IN receptacle	controller or RS232	three possible uses: 1. controller via coiled cord 2. connects to the communications port on a PC 3. if on a daisy chain, connects to the RS232 OUT port of the previous unit on the chain
	RS-232 OUT receptacle	handles outgoing communications	two possible uses: 1. if not on a daisy chain, is left open 2. if on a daisy chain, connects to the RS232 IN port of the next chained device; is left open if it is the last unit on the chain
TTL 	TTL port	allows peripheral devices to attach to the drive unit	attach digitally-controlled devices such as pumps, monitors, etc.; is left open if no peripherals are attached

Table 2-1 Communications Switches and Ports (*continued*)

Icon	Item	Purpose	Possible Settings and Uses
	Loopback switch	allows the drive unit to daisy-chain to other units	two possibilities: <ol style="list-style-type: none"> 1. UP: indicates the unit is a standalone unit OR the last item on a daisy chain 2. DOWN: indicates the unit is a member of a daisy chain, in any position except the last position
BAUD 	Baud Rate switch	controls the speed at which the drive unit communicates with other devices baud rate on the controller unit must match the baud rate on the drive unit at startup time; the default is 9600	six possibilities: <ul style="list-style-type: none"> 0 = 1200 1 = 2400 2 = 4800 3 = 9600 (system default value) 4 = 19200 5 = 38400 6 = Unused 7 = Unused 8 = Unused 9 = Unused
UNIT # 	Protocol switch	determines the hardware address and protocol of the drive unit; the default is Protocol 1 (position 0)	two possibilities: <ul style="list-style-type: none"> 0 = Protocol 1/RNO+Syntax (system default value) <ul style="list-style-type: none"> • maximum items on a chain is 16 1-F = DIN Protocol <ul style="list-style-type: none"> • if the drive unit is a member of a daisy chain then each member of the chain must have its own unique address • hardware address may/may not be out of sequence • maximum items on a chain is 15

Refer to Appendix E, RS-232 Communications with Manual ASCII Commands, and Appendix F, Protocols, for more detailed information about MICROLAB 500 system communications. Refer to Chapter 3, Programming and Using the MICROLAB 500 System, for more information about baud rate settings.

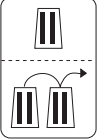
Installing Electrical Connections



Warning! Always make sure that the instrument is powered off before installing or removing any electrical connections. ⚠

Refer to Figure 2-2 and follow these steps to install electrical connections:

1. Plug the power cord into the power connector receptacle on the back of the drive unit. The power cord fits into the receptacle only one way.

The power connector receptacle accepts cords for either 115V or 220V.

2. Plug the hand probe (or foot pedal) jack into the probe connector receptacle. The probe connector receptacle is located on the upper right side of the drive unit.
3. The controller connector receptacle is located on the back of the drive unit below the serial number plate.

If you will be using the controller unit to communicate to the base unit, plug the controller cord into the receptacle just as you plug a telephone cord into a telephone outlet. Pinch the plastic locking device on the cord and insert it into the connector receptacle. Then release the plastic locking device, firmly attaching the cord.

4. If you will be using the drive unit to communicate to other devices, attach the appropriate cords.
 - To use the drive unit on a daisy chain, do not install the controller unit. Instead, install the interconnect cord (Part # 35833) and connect it to the RS-232 IN receptacle of the next device on the daisy chain. Leave the RS-232 OUT receptacle open if the drive unit is the last unit on the daisy chain.

For more information about possible communications options, refer to Table 2-1, Communications Switches and Ports.

Figure 2-2 Installing Electrical Connections

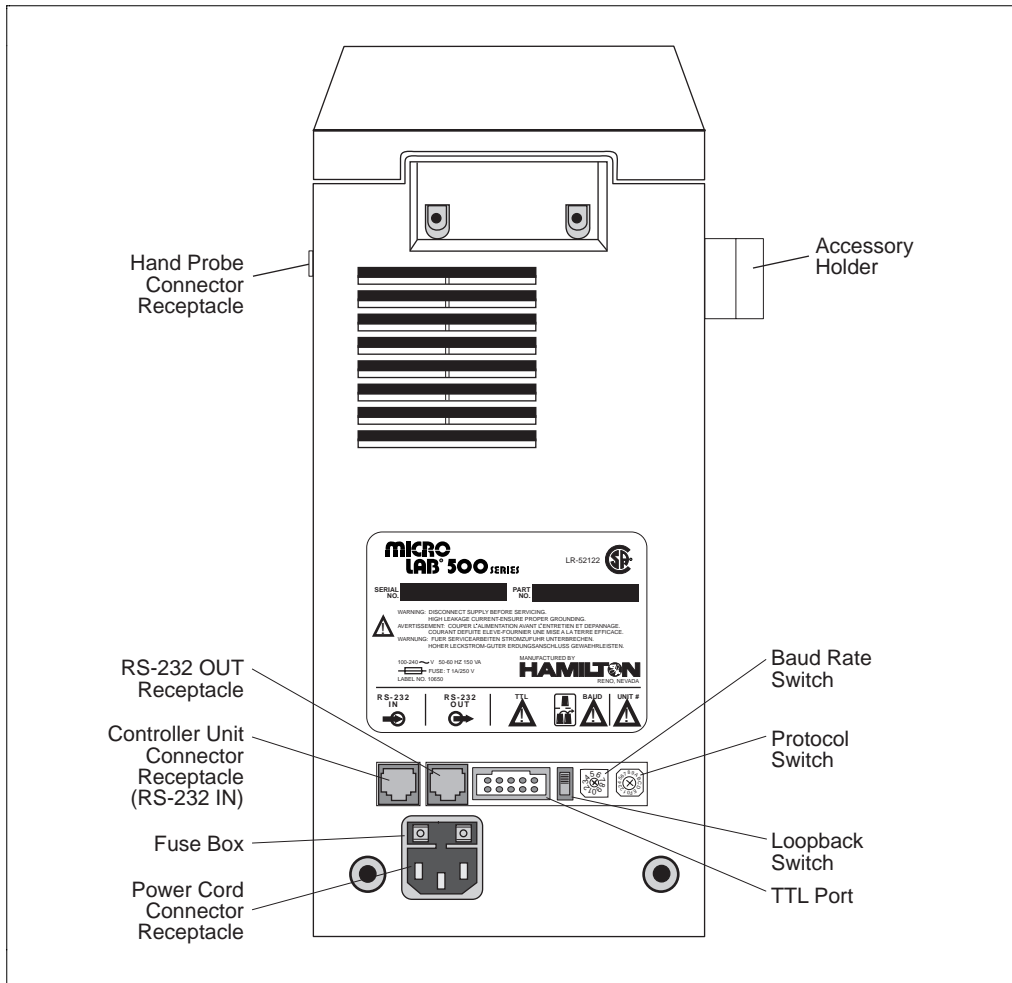

Installing Valve Assemblies

There are three types of valve assemblies for the MICROLAB 500 series. Instructions for installing valve assemblies follow.

Installing the Valve Assembly on the MICROLAB 510B/511C

The MICROLAB 510B/511C uses a single active valve assembly. To install the valve assembly, follow these steps:

1. Pick up the valve assembly. Make sure the PTFE luer fitting that attaches to the syringe is on the bottom of the assembly.
2. Holding the valve assembly, align the valve stem opening with the valve motor drive port on the drive unit. Press the valve assembly into place.
3. Push down on the valve lever to lock the valve assembly to the drive unit.

Figure 2-3 Installing a Valve Assembly on the MICROLAB 510B/511C

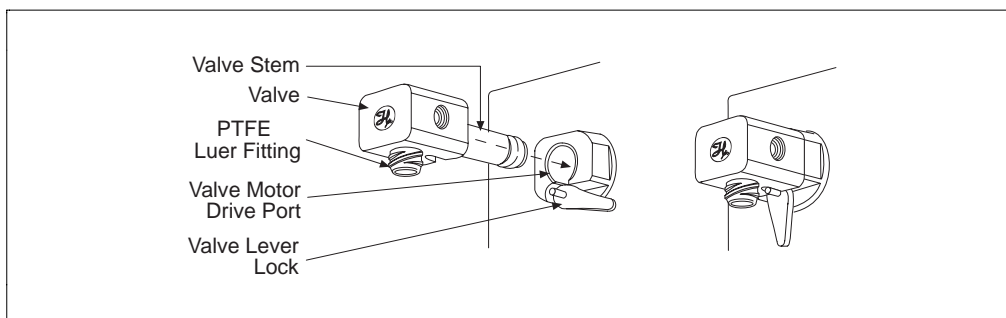

Installing Valve Assemblies on the MICROLAB 530B/531C and 540B/541C

Although the valve assemblies for the 530B/531C and 540B/541C units are different from one another, their installation procedures are the same. To install a valve assembly on either the MICROLAB 530B or 540B, follow these steps:

1. Pick up the valve assembly. Make sure the PTFE luer fittings that attach to the syringes are on the bottom of the assembly.
2. Insert the valve assembly into the valve motor drive ports and press the valve assembly into place.
3. Tighten the thumbscrew until it is finger-tight to secure the valve assembly to the drive unit.

Figure 2-4 Installing a Valve Assembly on the MICROLAB 530B/531C and 540B/541C

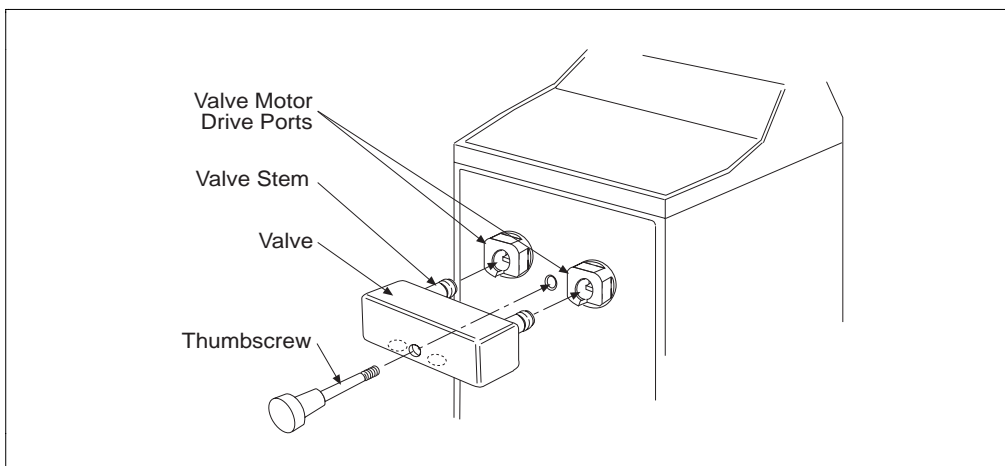

Selecting, Installing, and Removing Syringes

Before you install syringes on any MICROLAB instrument, you must first decide what syringes to use. Use Tables 2–2 and 2–3 to select the best syringe for your application. See Figures 2–5 through 2–7 for examples of different syringe types.

- The MICROLAB 510B/511C uses one dispenser/diluent-type syringe in the left position (TLL-type or TLLX-type syringes).
- The MICROLAB 540B/541C uses two dispenser/diluent-type syringes—one each in the left and right positions (TLL or TLLX).
- The MICROLAB 530B/531C uses one reagent/diluent syringe in the left position and one sample syringe in the right position (DX, TLL, or TLLX).
- As a general rule, to ensure high accuracy and precision, try to use 10% or more of a syringe's total volume. Consider using a different size syringe if your application calls for driving a syringe less than 10% of its total volume, and high accuracy and precision are required.

Table 2–2 Reagent/Diluent Syringes (TLL- and TLLX-types)

Syringe Sizes	Model Number	Part Number	Optimal Ranges (µL)
25 µL	1702 TLLX	80222	2.5–25
50 µL	1705 TLLX	80922	5–50
100 µL	1710 TLLX	81022	10–100
250 µL	1725 TLLX	81122	25–250
500 µL	1750 TLLX	81222	50–500
1 mL	1001 TLLX	81323	100–1000
2.5 mL	1002 TLL	81420	250–2500
5 mL	1005 TLL	81520	500–5000
10 mL	1010 TLL	81620	1000–10,000
25 mL	1025 TLL	82521	2500–25,000

Table 2-3 Sample Syringes (DX-type)

Syringe Sizes	Model Number	Part Number	Optimal Ranges (μL)
25 μL	1702 DX	80226	2.5-25
50 μL	1705 DX	80926	5-50
100 μL	1710 DX	81026	10-100
250 μL	1725 DX	81126	25-250
500 μL	1750 DX	81226	50-500
1 mL	1001 DX	81326	100-1000

See Appendix C for information regarding replacement parts for TLL, TLLX, and DX syringes.

Figure 2-5 The TLL-type Dispenser/Diluent Syringe

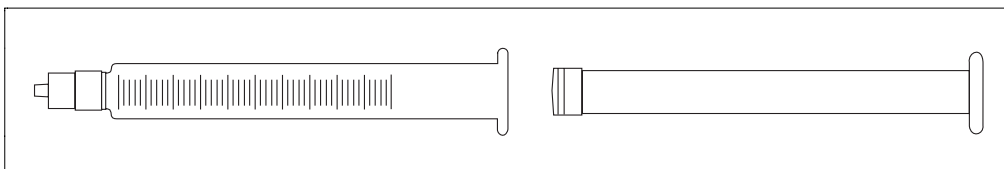

Figure 2-6 The TLLX-type Dispenser/Diluent Syringe

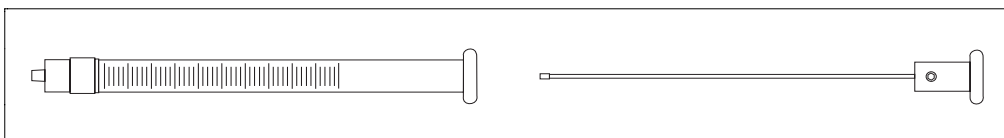
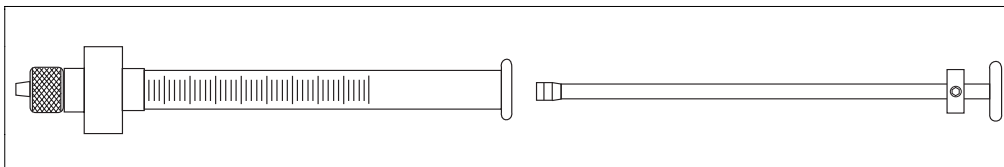

Figure 2-7 The DX-type Sample Syringe



Preparing Syringes for Installation

When you unpack a new syringe, notice that the syringe plunger is packed separately from the syringe barrel. You must condition the plunger tip before inserting the plunger into the barrel.

▲ Important Before using a new syringe for the first time, you must condition the syringe's PTFE plunger tip and glass barrel. To condition the tip and barrel, wet the plunger tip with distilled water or a solvent. (Medical-type silicone lubricants may be used to extend the lives of PTFE plunger tips. However, silicone may contaminate the process fluid.) Do NOT use viscous oils to lubricate plunger tips.

After wetting the plunger tip, insert the plunger into the glass barrel. Move the plunger in and out of the glass barrel approximately 10 times. Apply steady and even pressure; avoid twisting movements. ▲

Installing Syringes

Follow these steps to install syringes on any MICROLAB 500 system.

1. Condition all syringes before installation by following the procedure described in "Preparing Syringes for Installation."
2. Power on the MICROLAB system using the Power On/Off switch.
3. Press and hold the Step/Prime switch in the Step position, and move the syringe drive arm down from the Home position. Release the switch when the drive arm is about half-way between Home and the Down position.

4. Fasten the thumbscrew on the drive arm to the bottom of the syringe plunger. To fasten the thumbscrew, hold the plunger and screw the thumbscrew into the threaded fitting at the bottom of the syringe.
5. Pull the glass barrel up straight to the threaded female luer fitting that extends down from the bottom of the valve. Insert the male luer fitting into the valve fitting and turn the glass barrel clockwise until it is “finger-tight.”

See Figure 2–8, Installing a Syringe, for an illustration of these steps.

Figure 2–8 Installing a Syringe

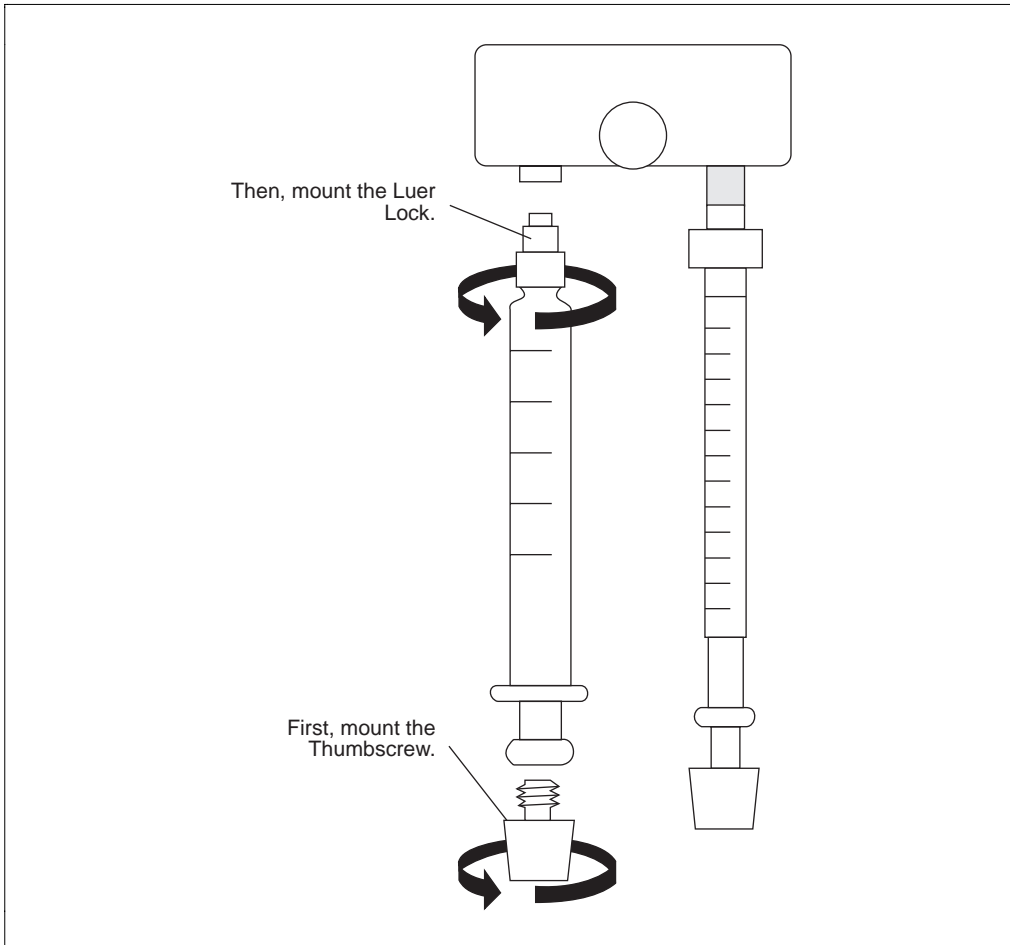

- ▲ Important** Always tighten syringes so they are “finger-tight.” Syringes that are over- or under-tightened can cause problems for your MICROLAB 500 system.
- Syringes that are over-tightened may cause leaks or may damage the valve.
 - Syringes that are under-tightened may cause leaks.
 - Syringes that are not screwed on straight may leak and cause lateral strain on the syringe luer fitting as it connects to the bottom of the valve. ▲

Removing Syringes

To remove syringes, reverse the installation procedure.

1. Power on the system using the Power On/Off switch.
2. Use the Step/Prime switch to move the syringe drive arm down from the Home position. Release the switch when the drive arm is about half way between Home and the Down position.

- ▲ Important** Before you use the Prime function, direct the probe toward a liquid waste container or reservoir since initialization may expel any fluid remaining in the syringes. ▲

3. Release the glass barrel by turning it counterclockwise.
4. Unfasten the thumbscrew on the drive arm at the bottom of the syringe plunger. To unfasten the thumbscrew, hold the plunger and unscrew the thumbscrew from the threaded fitting at the bottom of the syringe.

Refer to Figure 2-9, Removing a Syringe, for an illustration of the removal procedure.

Figure 2-9 Removing a Syringe

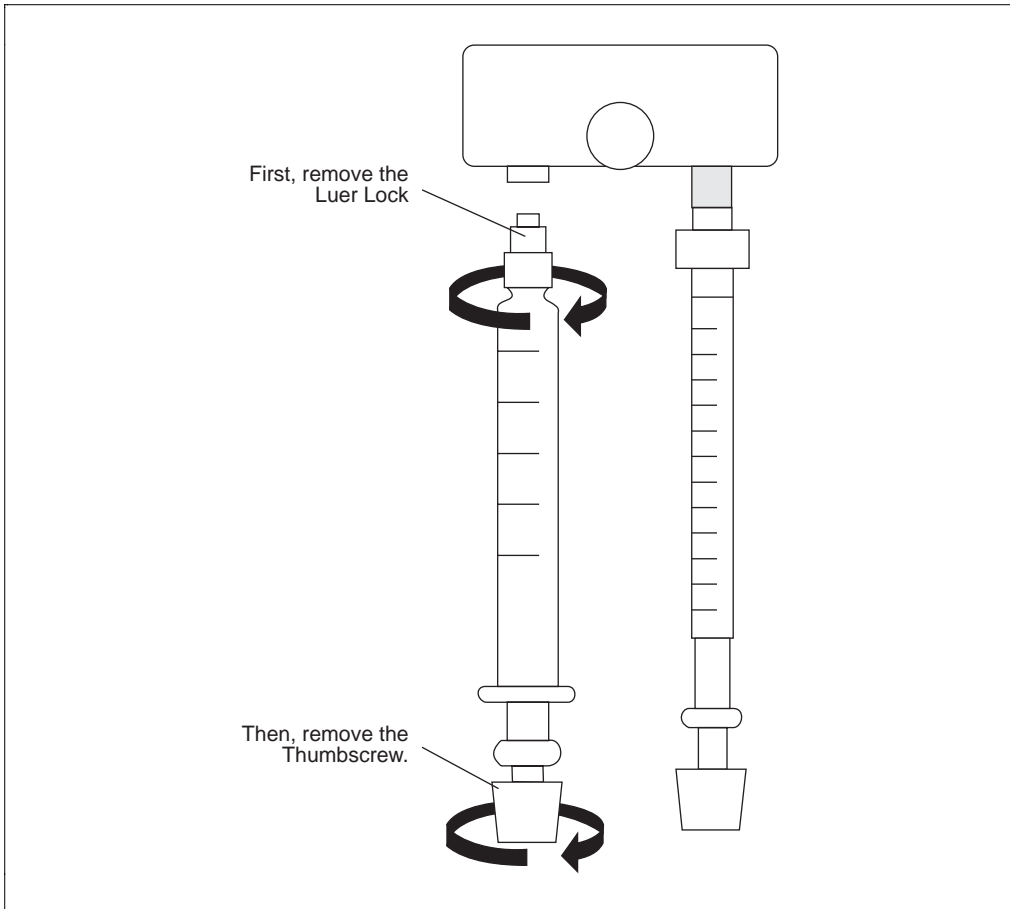

Warning! Avoid the risk of injury or infection! Use extreme caution when removing cracked or splintered syringes. Always wear thick gloves and protective eye wear when replacing syringes. ⚠

Selecting and Installing Tubing

This section provides information about selecting and installing tubing on all MICROLAB 500 systems.

Selecting Tubing

Each MICROLAB system includes two gauges of fill and dispense tubing: 12- and 18-gauge. Fill tubing has a 90° cut on the end opposite the fitting; dispense tubing has a tapered end opposite the fitting.

When selecting tubing, consider the volume and the viscosity of the liquid you plan to pipette. Refer to Table 2-3, Tubing Selection Guide, for help in selecting tubing.

Table 2-4 Tubing Selection Guide

Syringe Size	Tubing Gauge for Standard Aqueous Solutions	Tubing Gauge for Viscous and Foaming Liquids
25 µL	18	18
50 µL	18	18
100 µL	18	18
250 µL	18	18
500 µL	18	18
1 mL	18	18
2.5 mL	18	12
5 mL	12	12
10 mL	12	12
25 mL	12	12

- ★ **Note: If you have a MICROLAB 530B/531C diluter and plan to use syringes of two different sizes, choose tubing to accommodate the syringe with the larger volume. ★**

See Appendix C for information about ordering extra tubing.

Installing Tubing

1. Before installing tubing lines, wet the tubing fittings.
 2. Make sure the tubing lines do not contain crimps or blockages. Crimps or blockages can cause leaks or can cause the system to overload. If tubing is crimped, replace it with new tubing.
- ▲ Important Fasten tubing so it is finger-tight and snug enough to prevent leaks. Avoid using tools to tighten tubing. Excessive tightening may damage tubing, valve fittings, or flanges. ▲**
3. Install the fill tubing. You can differentiate fill tubing and dispense tubing since dispense tubing has a tapered end.
 - For all MICROLAB 500 models, install the fill tubing on the left, or input side of the valve. Thread the tubing fitting into the left valve port, and screw it in so it is finger-tight.
 - For the MICROLAB 540B/541C only, install a second fill tubing line on the right side of the valve. Thread the tubing fitting into the right valve port, and screw it in so it is finger-tight, just as you did on the right side.
 4. Once the fill tubing is installed, attach a tubing clip to it. Slip the tubing clip over the end of the tubing, then attach the clip to the side of the reservoir.

5. Install the dispense tubing. You can recognize dispense tubing by its tapered end.
 - If you are using a MICROLAB 510B/511C, install the dispense tubing on the right side of the valve. Thread the tubing fitting into the right valve port and screw it in so it is finger-tight. See Figure 2-10 for an illustration of the valve and tubing connectors.

Figure 2-10 MICROLAB 510B/511C Valve and Tubing Connections

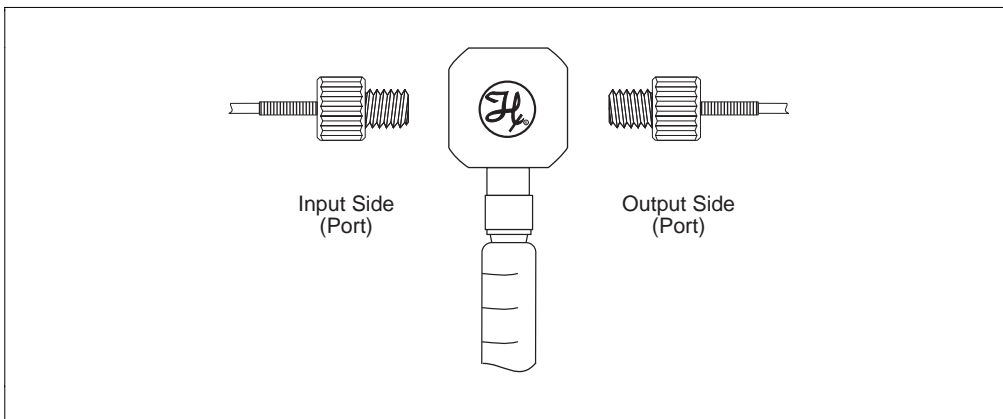

- If you are using a MICROLAB 530B/531C with a D syringe, install the dispense tubing on the side port of the D syringe. See Figure 2-11. When using a TLL syringe as a sampling syringe, install dispense tubing directly onto the valve assembly. To do this, remove the valve plug and replace the plug with dispense tubing. See Figure 2-12.

Figure 2-11 MICROLAB 530B/531C Valve with a D Configuration Syringe

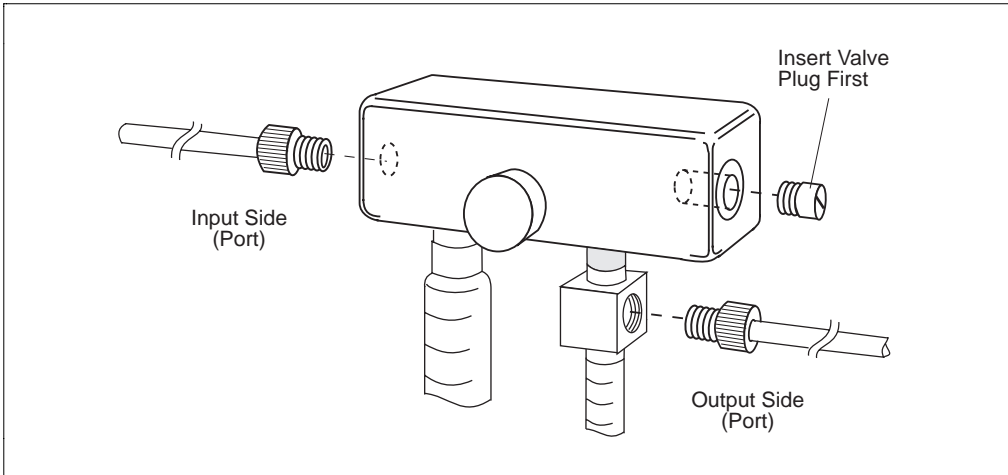
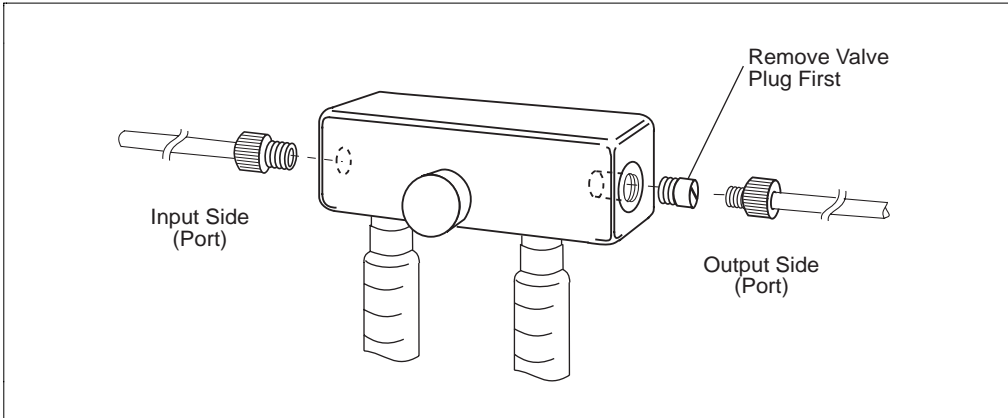
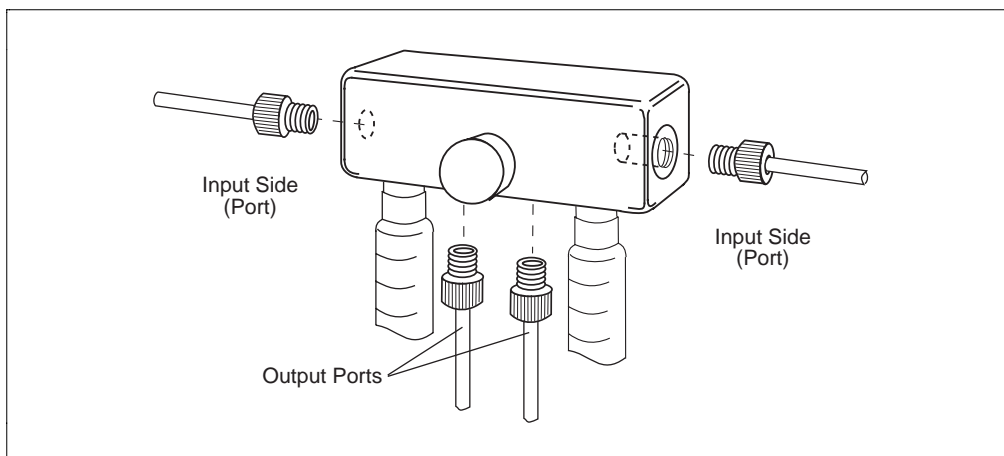

Figure 2-12 MICROLAB 530B/531C Valve with Two TLLX or TLL Syringes



- If you are using a MICROLAB 540B/541C, install a tapered dispense tubing line into each of the valve's front ports. The front ports are located on the bottom of the valve between the two syringes. Thread the tubing fittings into the front ports, and screw the fittings in so they are finger-tight. See Figure 2-13.

Figure 2-13 MICROLAB 540B/541C Valve and Tubing Connectors



*** Note:** It is possible to use the 540B/541C dual dispenser as a single dispenser. When programming, designate the instrument as a single dispenser. *

6. Install the dispense tubing to the hand probe.
 - If you are using the MICROLAB 510B or the MICROLAB 530B, the Concorde Probe comes as standard equipment. This probe uses a single dispense tube. To attach the dispense tubing into the probe, loosen the knurled screw at the upper end of the probe. Slide the tapered end of the dispense tube through the probe so that the tubing passes out the end of the probe. When enough tubing for you to work with extends from the probe, tighten the knurled screw to secure the tubing line.

- If you are using the MICROLAB 540B, the Dual Hand Probe comes as standard equipment. This probe is designed for both 18- and 12-gauge tubing. Use the tubing reducer (Part # 35770) that is provided with the dual hand probe if you wish to use 18-gauge tubing. See Figure 2-14.

Figure 2-14 Using the Tubing Reducer with the Dual Hand Probe

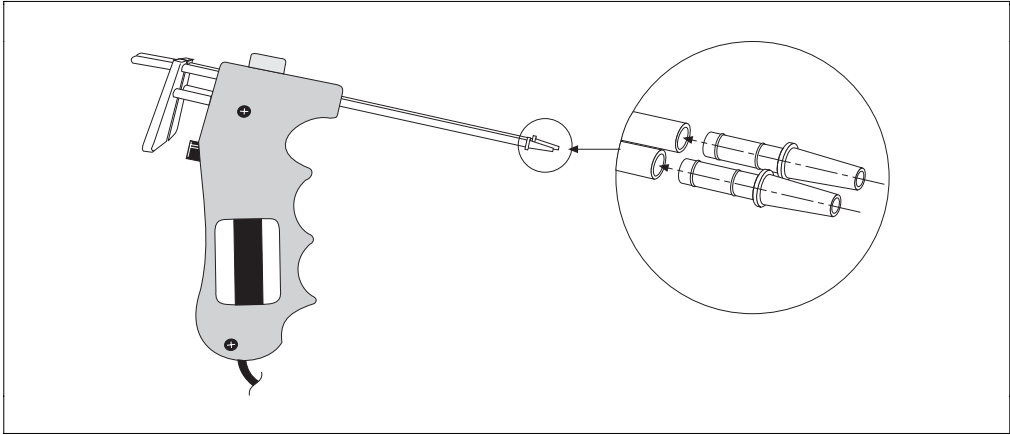

7. Fill out the warranty card and return it to Hamilton Company.
8. You are now ready to use your MICROLAB 500 system.

Chapter 3 Programming and Using the MICROLAB 500B System

This chapter contains information about the following topics:

- an overview of the MICROLAB 500 functions
- using the controller unit keys
- accessing the Main menu
- priming and checking the system
- creating methods
- running methods
- using the Utility menu functions

For information on controlling 500C systems, refer to Appendixes E and F.

Figure 3-1 Using the MICROLAB 500B

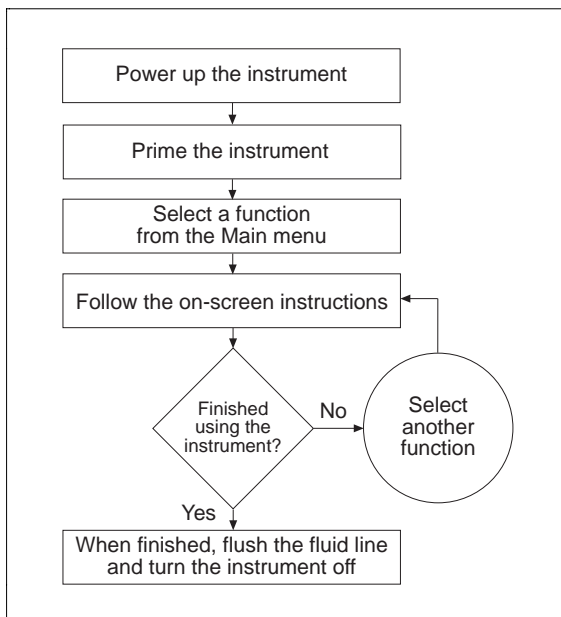
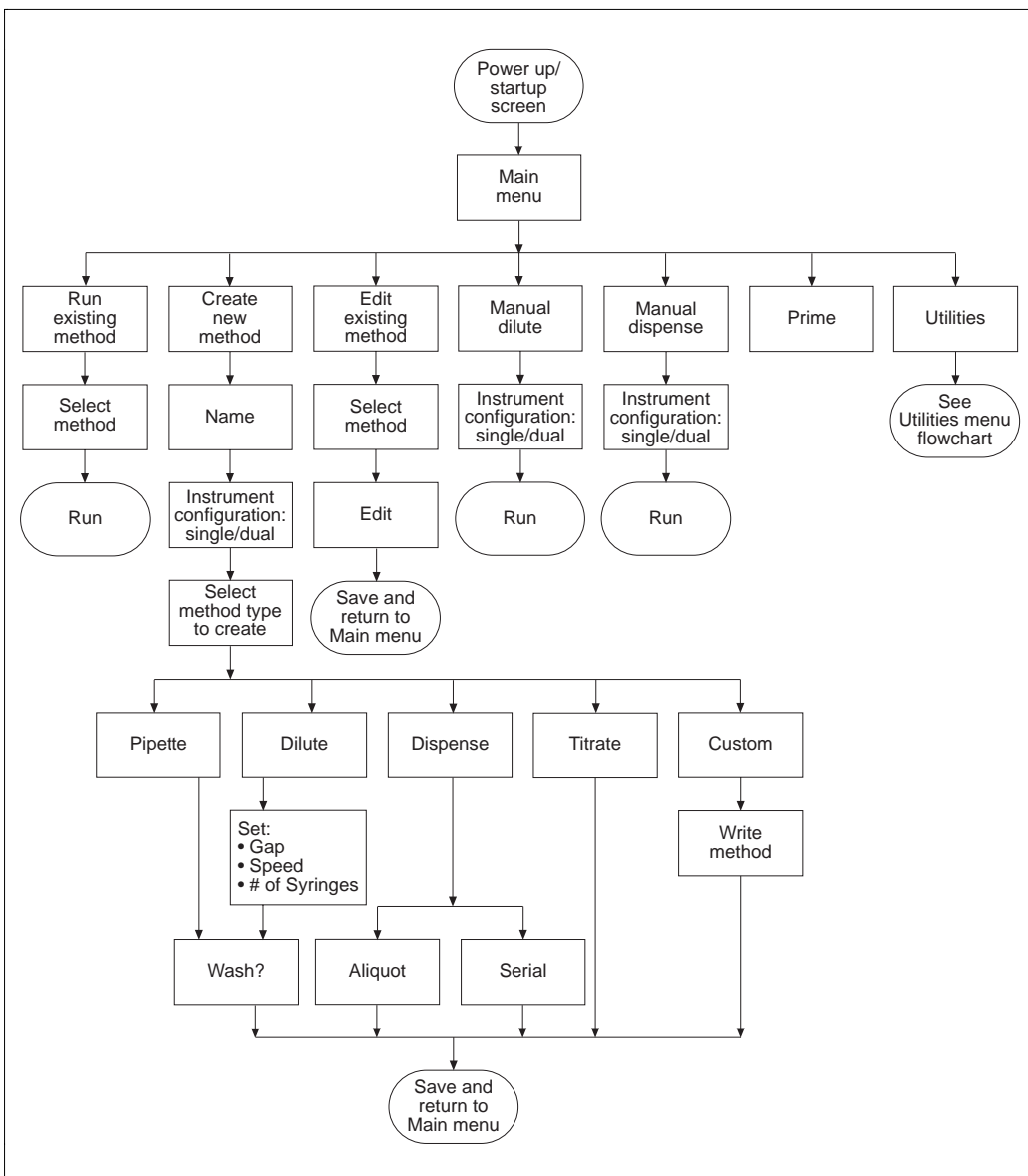

Figure 3-2 provides an overview of the functions available using the MICROLAB 500B. These functions are described in detail later in this chapter.

Figure 3-2 Overview of MICROLAB 500B Functions



Using the Controller Unit

Use the controller unit to create and run methods, to enter and change data, and to perform utility functions. Figure 3-3 shows the controller unit.

Figure 3-3 The Controller Unit

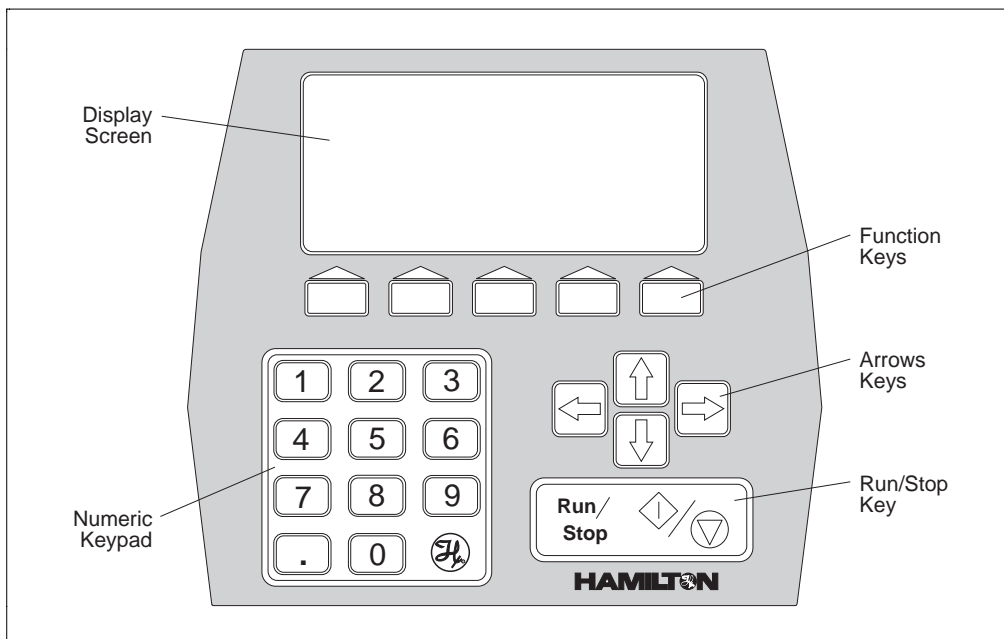

Using the Arrow Keys

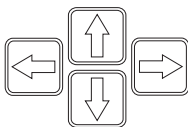

The arrow keys are located on right side of the controller unit, between the function keys and the Run/Stop key. Use the arrow keys to move from one data entry field to another on the display screen; each key moves you in the direction that it points. The current field is highlighted in reverse video on the display screen. In this manual, items are highlighted with boldface text.

Using the Numeric Keypad

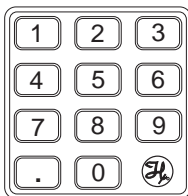

The numeric keypad is located in the lower left corner of the controller unit. Use the numeric keypad to enter numeric data when using the edit mode (see “Editing Conventions” for information about the edit mode).

Using the Run/Stop Key



The Run/Stop key is located in the bottom right corner of the controller unit. This key generates a command signal that activates the next step or pauses the unit during a method. You can also generate a start signal by pressing the button on a hand probe or by using a footswitch.

Using the Function Keys

The function keys are located directly below the display screen. Use these keys to perform specific actions, based on the requirements of the current screen. To perform an action, press the function key located beneath the action. Not all actions are available from all screens.

Table 3–1 Function Key Actions

SELECT	selects the highlighted element on the screen so it can be edited or acted upon in some manner
ESCAPE	returns you to the previous screen without saving any changes; also abandons the current edit mode process
ACCEPT	accepts the displayed screen with any changes
CONFIRM	verifies that you want to save your changes or that you want to perform an action
DELETE	deletes the highlighted element on the screen
ENTER	accepts the underlined value entered while in edit mode
MODE	allows you to choose the next operation to be performed in a manual method

Editing Conventions

To use the edit mode, press the appropriate arrow key to move to the desired screen location. Then press the SELECT function key; you must always press SELECT before you can change the value of any highlighted item. For example, to enter a size for a syringe, use an arrow key to move to and highlight the syringe size field.

Instrument configuration				
One syringe instrument				
Two syringe instrument				
Left Syringe size (uL): 1000.0				
Right Syringe size (uL): 1000.0				
SELECT item to edit-ACCEPT if complete				
	SELECT	ESCAPE	ACCEPT	

When you press SELECT, notice that the highlighting changes to underlining. Now you can edit the underlined value; instructions for data entry appear near the bottom of the screen. Use the arrow keys (or in some cases, the numeric keypad numbers), to increase or decrease the underlined value. When you are satisfied with your entry, press ENTER.

Instrument configuration				
One syringe instrument				
Two syringe instrument				
Left Syringe size (uL): <u>2000.0</u>				
Right Syringe size (uL): 1000.0				
Use arrow keys to change syringe size				
	ENTER	ESCAPE		

Pressing ENTER returns you to the previous screen, keeping the data entry change you just made. When you are finished editing, press ACCEPT to use the values displayed in all fields on the screen.

Instrument configuration				
One syringe instrument				
Two syringe instrument				
Left Syringe size (uL): 2000.0				
Right Syringe size (uL): 1000.0				
SELECT item to edit-ACCEPT if complete				
	SELECT	ESCAPE	ACCEPT	

Powering on the MICROLAB 500

To power on the MICROLAB 500, press the Power On/Off switch located on the front panel of the drive unit. When the instrument powers up, it performs an electronic self-test and beeps twice. The first time that you start up the instrument, you see the following screen:

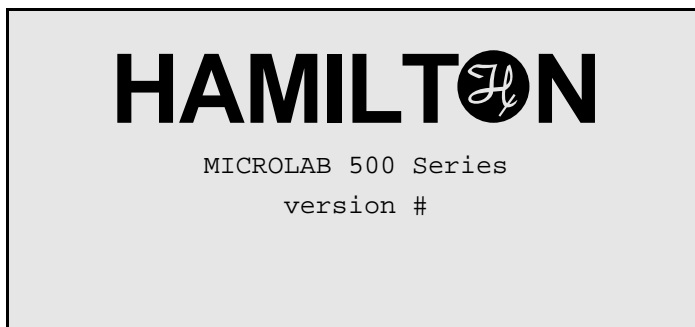

Next, the “Change default language” screen appears:

Change default language				
English				
Francais				
Deutsch				
Português				
Español				
Clear default language				
SELECT menu item				
SELECT				

Select a default language. The language that you select will become the system default, and all future screens will appear in that language. You will not be prompted again for a default language at startup. See “Changing the Default Language” later in this chapter for more information.

The Main Menu

After you select a default language, the Main menu appears:

MICROLAB 500 main menu				
Run an existing method				
Create a new method				
Edit an existing method				
Manual dilution				
Manual dispense				
Prime the fluid path				
Utilities menu				
SELECT menu item				
SELECT				

Use the arrow keys to highlight the desired function. Then press SELECT. Information about each of the Main menu functions follows in this chapter.

Priming the MICROLAB 500

This section describes how to set up and prime the MICROLAB 500.

Preparing to Prime

Prime the MICROLAB 500 system before using it for the first time, at the start of a work day, and between fluid changes. Run fluid through the tubing lines to ensure that there are no bubbles or air gaps in the tubing. Check the fluid path for leaks and clean the fluid path, if necessary.

To prime the MICROLAB 500 and check the fluid path for leaks, follow these steps:

1. Fill a reservoir with deionized water. Place the end of the inlet tubing in the reservoir. Use the tubing clip to attach the tubing to the side of the reservoir.
2. Place the hand probe over the same reservoir or over a waste container.
3. Push the Prime switch on the drive unit OR select the Prime function from the main menu. See the next section, Using the Prime function from the Main menu, for more information.
4. Run the instrument in Prime mode until water flows through the entire system.
5. If the system is airtight, the fluid path will contain a solid column of water.
 - If you see air bubbles in the fluid path, the system is not airtight. Adjust the tubing fittings or syringes. Check that all parts are snug and finger-tight.
 - If you do not see air bubbles in the fluid path, the system is airtight.

6. If you do not see air bubbles in the fluid path, but small bubbles appear on the PTFE surface of the syringe, clean the internal fluid path with a mild syringe cleaner. Rinse with deionized water to rid the system of cleaning fluid. To clean the fluid path, follow the steps in Chapter 4, Caring for the MICROLAB 500.
 7. After cleaning, reprime with deionized water to rinse the fluid path. Continue priming until you do not see any bubbles.
 8. Remove the inlet tubing from the reservoir and prime air through the system. Priming air through the system clears the fluid path of the deionized water that you used as a rinse.
 9. When the fluid path is free of deionized water, place the inlet tubing into a reservoir of the liquid you wish to dispense or use as a diluent. Prime this fluid through the system.
- ★ **Note: When priming reagent after a deionized water rinse, dispense the first shot into a waste container, since it will contain a certain amount of the water droplets that remained in the tubing line. ★**
10. Your MICROLAB 500 system is clean and ready for use.

▲ **Important** Do not operate either side dry, as this may cause excessive wear on the syringes and valves. ▲

Figure 3–4 shows the required steps for priming the instrument.

Figure 3–4 Priming the MICROLAB 500

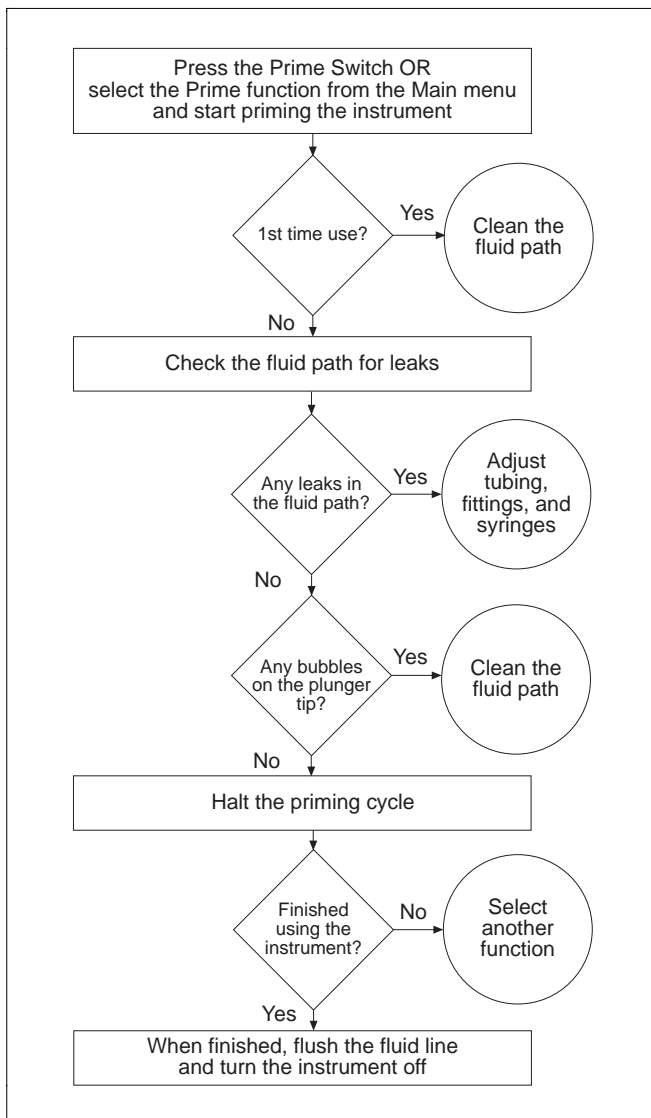

Using the Prime Function from the Main Menu

1. From the Main menu, SELECT the “Prime the fluid path” function. The following screen appears:

Drive unit initialization				
Any fluid in the syringes on the drive unit will now be purged. Please ensure the probe is directed towards a waste area.				
CONFIRM to continue, ESCAPE to exit				
		ESCAPE	CONFIRM	

- ▲ **Important** When you select the Prime method, the instrument alerts you that the fluid in the syringes is about to be purged. Be sure to place the probe over a fluid waste area or a reservoir before pressing CONFIRM to continue the priming function. ▲

2. Press CONFIRM to continue the priming process.
3. The following screen appears:

Prime the fluid path				
Full Cycles:		10		
Syringe prime speed:		4		
SELECT item to edit-RUN to start				
	SELECT	ESCAPE		

- Enter the desired number of priming cycles; 10 is the default.
- Enter the prime speed. Speed must be in whole seconds, from 1 to 250.
- Press the Run/Stop key to start the priming cycle.

4. The instrument displays the status of the priming cycle.

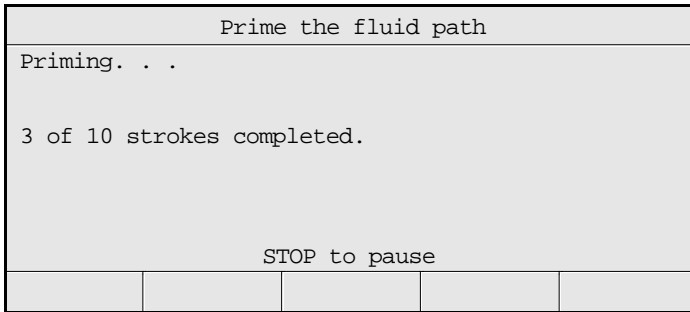

- Press the Run/Stop key to pause the priming cycle. If you pause the priming cycle, you see the following screen:

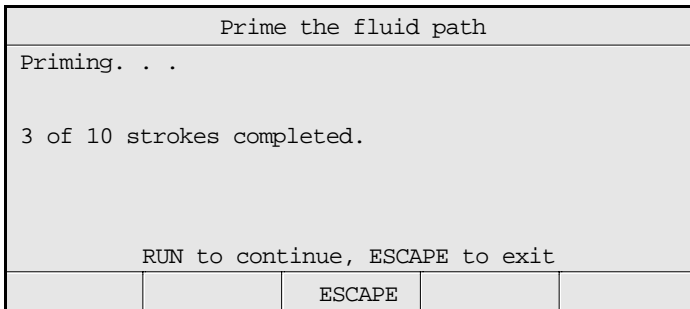

- Press the Run/Stop key once again to resume the cycle or press ESCAPE to exit the cycle.
5. When the cycle is complete, the instrument displays a message stating that the prime is complete. Press any key to return to the main menu.

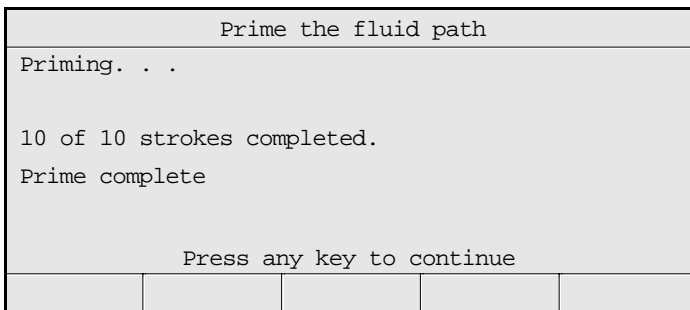

Creating a New Method

Use this function to create and save a new method in the method storage area. You can create and save up to 21 methods. To create a new method, follow these steps:

1. From the main menu, use the arrow keys to highlight the “Create a new method” function, then press SELECT.
2. The instrument displays the method storage area with an unused method location already highlighted. Unused method locations are denoted by the term “<UNUSED>”. If desired, use the arrow keys to move to another location. Press SELECT to use a highlighted location or press ESCAPE to return to the main menu without creating a new method.

Create a new method			
<UNUSED>	<UNUSED>	<UNUSED>	
<UNUSED>	<UNUSED>	<UNUSED>	
<UNUSED>	<UNUSED>	<UNUSED>	
<UNUSED>	<UNUSED>	<UNUSED>	
<UNUSED>	<UNUSED>	<UNUSED>	
<UNUSED>	<UNUSED>	<UNUSED>	
<UNUSED>	<UNUSED>	<UNUSED>	
SELECT an UNUSED method			
	SELECT	ESCAPE	

3. If you press SELECT, you access the following screen:

Create a new method				
1 2 3 4 5 6 7 8 9 -				
Q W E R T Y U I O P				
A S D F G H J K L				
Z X C V B N M				
SPACE				
Name: _____				
SELECT next letter-ACCEPT if complete				
	SELECT	ESCAPE	ACCEPT	DELETE

Use the arrow keys to spell out the new method's name, using up to 10 characters.

- To accept a character, press SELECT.
 - To erase a character, press DELETE.
 - Press ESCAPE to return to the main menu without creating a new method.
 - Press ACCEPT when you are finished naming the new method.
4. Next, the instrument prompts you for the configuration you are using. Use the arrow keys to highlight either a one- or a two-syringe instrument configuration.

Instrument configuration			
One syringe instrument			
Two syringe instrument			
SELECT menu item			
SELECT	ESCAPE		

- Press SELECT to accept the highlighted instrument configuration.
 - Press ESCAPE to return to the previous screen without selecting an instrument configuration.
5. Once you select an instrument configuration, you are prompted to enter syringe size(s). For example, in the following screen the user has selected a two-syringe instrument. The system supplies default syringe sizes.

Instrument configuration				
One syringe instrument				
Two syringe instrument				
Left Syringe size (uL): 1000.0				
Right Syringe size (uL): 1000.0				
SELECT item to edit-ACCEPT if complete				
	SELECT	ESCAPE	ACCEPT	

6. You can use the default values that are displayed, or you can enter new sizes. To enter a new size, use the arrow keys to highlight the appropriate syringe, then press SELECT. Notice that the highlighting changes to an underline, as shown in the following screen:

Instrument configuration				
One syringe instrument				
Two syringe instrument				
Left Syringe size (uL): <u>2500.0</u>				
Right Syringe size (uL): 1000.0				
Use arrow keys to change syringe size				
	ENTER	ESCAPE		

Now, use the arrow keys to increase or decrease the syringe size. When you have selected the correct size, press ENTER.

★ **Note: You must use the arrow keys to change syringe sizes.** ★

7. Press ACCEPT to accept all syringe size values shown on the screen. The “Method type to create” menu appears:

Method type to create				
Aliquot dispense method				
Serial dispense method				
Dilute method				
Pipette method				
Titrate method				
Custom method				
SELECT menu item				
	SELECT	ESCAPE		

8. SELECT a method type. Each individual method consists of a series of screens and prompts that are described in detail. Refer to the following sections for information about creating specific methods.
9. When you are finished creating a method, the “Save method in method memory” screen appears. This screen shows the name of the new method.

Save method in method memory				
Method: NEW1				
will be stored in method memory.				
CONFIRM to save, ESCAPE to cancel				
		ESCAPE	CONFIRM	

- Press CONFIRM to save the method, then press any key to continue.
- Press ESCAPE to return to the previous screen.

Creating an Aliquot Dispense Method

Use this function to create an aliquot dispense method. An aliquot dispense method consecutively dispenses **equal** amounts of liquids.

1. Follow steps 1–8 under “Creating a New Method.” Select the “Aliquot dispense method” function from the “Method type to create” menu. The “Aliquot dispense parameters” screen appears:

Aliquot dispense parameters			
	Left	Right	
Aliquot volume (uL):	2500.0	250.0	
Maximum aliquots:	1	1	
Aliquots to dispense:		1	
Syringe fill speed:	4	2	
Syringe dispense speed:	4	2	
Syringe fill mode:		AUTO	
SELECT item to edit-ACCEPT if complete			
	SELECT	ESCAPE	ACCEPT

2. Enter the volume(s) to be aliquoted. To enter a volume, use the arrow keys to highlight the Aliquot volume field, then press SELECT. The highlighting changes to underlining. Use the number keys to enter a new volume. When satisfied with your entry, press ENTER. The underline disappears and the highlighting reappears.

★ **Note: You cannot enter a value in the Maximum Aliquots field. The system automatically calculates Maximum Aliquots: Maximum Aliquots = Total volume / Aliquot volume** ★
3. Enter the number of aliquots to be dispensed. Note that this number cannot be larger than the calculated number in the Maximum Aliquots field.
4. Enter the syringe fill speed.
5. Enter the syringe dispense speed.

6. Enter the syringe fill mode; this mode can be either Auto or Manual. Use the arrow keys to change the current mode.
 - Auto mode means that the instrument will perform the fill function automatically when you run the method.
 - Manual mode means you must press the Run/Stop key or press the probe button to activate the fill function when you run the method.
7. When you are satisfied with your entries, press ACCEPT. The instrument displays the “Save method in method memory” screen. Press CONFIRM to save the method, then press any key to continue.

Creating a Serial Dispense Method

Use this function to create a serial dispense method that serially dispenses various amounts of liquids.

1. Follow steps 1–8 under “Creating a New Method.” Select the “Serial dispense method” function from the “Method type to create” menu. The “Serial dispense volumes” screen appears:

Serial dispense volumes (uL)			
Left Used	2500.0	Right Used	250.0
Available	0.0	Available	0.0
1.	2500.0		250.0
2.			
3.			
4.			
5.			
SELECT item to edit-ACCEPT if complete			
	SELECT	ESCAPE	ACCEPT DELETE

2. Enter the volumes to be dispensed from the syringes. Notice that default values to be dispensed are 100%, with the amount available 0%. As soon as you enter an amount to be dispensed, the system recalculates the volume available.

- ★ **Note:** Notice that default value for the “Used” field is 100% of the syringe size, and the default value for the “Available” field is 0% of the syringe size. As enter amounts to be dispensed, the system recalculates the volumes:

Used = Sum of all dispense amounts entered on all lines

Available = (Syringe size - Used) ★

- Enter up to 20 command lines; the screen will scroll as you add lines. If you enter more than 20 lines, you return to line one.
3. Press DELETE to delete an entry. Use the arrow keys to move about from line to line. When you are finished entering amounts to be dispensed, press ACCEPT.
 4. The system displays the “Serial dispense method parameters” screen:

Serial dispense method parameters			
Dispenses:	1	Left	Right
Fill volume (uL):	2500.0		250.0
Syringe fill speed:		4	2
Syringe dispense speed:		4	2
Syringe fill mode:		AUTO	
SELECT item to edit-ACCEPT if complete			
	SELECT	ESCAPE	ACCEPT

5. Enter syringe fill speeds.
6. Enter syringe dispense speeds.
7. Select a syringe fill mode. Valid modes are AUTO or MANUAL.
 - Auto mode means that the instrument will perform the fill function automatically when you run the method.
 - Manual mode means you must press the Run/Stop key or press the probe button to activate the fill function when you run the method.
8. When you are satisfied with your entries, press ACCEPT. The system displays the “Save method in method memory” screen. Press CONFIRM to save the method, then press any key to continue.

Creating a Dilution Method

Use this function to create a dilution method to perform the following tasks:

- Fill the diluent syringe (if using a two-syringe instrument, the left syringe) with a specified volume.
 - With or without a time delay (of up to 60 seconds), aspirate an air gap volume and then a sample volume into the left syringe (if using a single-syringe instrument) or into the right syringe (if using a two-syringe instrument).
 - Dispense the diluent and the sample volumes.
 - Wash the probe tip up to one full cycle.
1. Follow steps 1-8 under “Creating a New Method.” Select “Dilute method” from the “Method type to create” screen. The “Dilute method” screen appears:

Dilute method			
Ratio	1:		10.0
Dilution	1/		11.0
Left Diluent volume (uL):			2500.0
Right Air gap volume (uL):			0.0
Right Sample volume (uL):			250.0
Final volume (uL):			2750.0
SELECT item to edit-ACCEPT if complete			
	SELECT	ESCAPE	ACCEPT

2. Enter two values in this screen. Choose from among the following pairs of numbers to enter:
 - Ratio and Diluent volume
 - Ratio and Sample volume
 - Ratio and Final volume
 - Diluent volume and Sample volume
 - Diluent volume and Final volume
 - Sample volume and Final volume

3. You may, but are not required to, enter an air gap volume.
 - If using a one syringe instrument, Final volume plus Air gap volume cannot exceed 105% of the syringe size selected.
 - If using a two syringe instrument, Diluent volume cannot exceed 105% of the left syringe size selected. Sample volume plus Air gap volume cannot exceed 105% of the right syringe size selected.

4. Press ACCEPT and the controller calculates the other values

★ **Note: Ratio = 1 : (Diluent volume / Sample volume)**

Dilution = 1 / ([Diluent volume + Sample volume] / Sample Volume), that is, Dilution = Ratio/(Ratio + 1)

Final volume = Diluent volume + Sample volume

The resolution of the installed syringes may limit the system's ability to accommodate your exact dilutions or ratios. The system will try to calculate the closest possible combinations. If such combinations cannot be achieved using the installed syringes or the total volumes, the system will display an error message stating the problem. ★

6. The "Dilute method parameters" screen appears:

Dilute method parameters				
	Left	Right		
Syringe fill speed:	4			
Syringe aspirate speed:		2		
Syringe dispense speed:	4	2		
Syringe fill mode:	AUTO			
Air gap mode:	N/A			
Air gap delay:	N/A			
SELECT item to edit-ACCEPT if complete				
	SELECT	ESCAPE	ACCEPT	

7. Enter a fill speed for the left syringe.
8. Enter an aspirate speed for the right syringe.
9. Enter the dispense speeds for both syringes.

10. Select a syringe fill mode. Valid modes are AUTO or MANUAL.
 - Auto mode means that the instrument will perform the fill function automatically when you run the method.
 - Manual mode means you must press the Run/Stop key or press the probe button to activate the fill function when you run the method.
11. You may, but are not required to, enter an air gap volume.
 - If you enter an air gap volume greater than 0, specify a mode type. Valid mode types are either MANUAL or AUTO.
 - If you select MANUAL mode, you must pick up the air gap manually by using the Run/Stop key or the probe button.
 - If you select AUTO mode, the instrument will pick up the air gap automatically. You may select a time delay period, from 0 to 60 seconds. The default is 0.3 seconds.
 - If you do not select an air gap volume, "N/A" appears in the air gap mode and delay fields on the screen.
12. The "Probe wash parameters" screen appears:

Probe wash parameters			
Wash volume (uL)	0.0		
Left Syringe fill speed:	4		
Left Syringe dispense speed:	4		
SELECT item to edit-ACCEPT if complete			
SELECT	ESCAPE	ACCEPT	

Enter fill and dispense speeds. The syringe automatically fills with the wash volume. However, you must use the Run/Stop key or the probe switch to complete the wash cycle.

- If you are using a ML510B or a ML530B, you can wash the probe directly from the left syringe.
 - If you are using a ML540B, you cannot wash the right syringe or probe.
13. When you are satisfied with your entries, press ACCEPT. The system displays the “Save method in method memory” screen. Press CONFIRM to save the method, then press any key to continue.

Creating a Pipette Method

Use this function to create a pipette method. A pipette method aspirates the same volume as it dispenses. The total actual volume dispensed, however, may include an air gap volume. A pipette method performs the following tasks:

- With or without a time delay (of up to 60 seconds), aspirate an air gap volume and then aspirate an amount of sample fluid into the left syringe (if using a single syringe instrument) or into the right syringe (if using a dual syringe instrument).
 - Dispense both the sample fluid and the air gap volumes from the syringe.
 - Wash the syringe.
1. Follow steps 1–8 under “Creating a New Method.” Select the “Pipette method” function from the “Method type to create” menu. The “Pipette parameters” screen appears:

Pipette parameters				
Right Air gap volume				0.0
Right Dispense volume				250.0
Right Syringe aspirate speed:				2
Right Syringe dispense speed:				2
Air gap mode:				N/A
Air gap delay:				N/A
SELECT item to edit-ACCEPT if complete				
	SELECT	ESCAPE	ACCEPT	

2. You may, but are not required to, enter a Right Air gap volume.
 - If you enter an air gap volume greater than 0, specify a mode type. Valid mode types are either MANUAL or AUTO.
 - If you select MANUAL mode, you must pick up the air gap manually by using the Run/Stop key or the probe button.
 - If you select AUTO mode, the instrument will pick up the air gap automatically. You may select a time delay period, from 0 to 60 seconds. The default is 0.3 seconds.
 - If you do not select an air gap volume, "N/A" appears in the air gap mode and delay fields on the screen.
3. Enter the Right Dispense volume.
4. Enter a Right Syringe aspirate speed.
5. Enter Right Syringe dispense speed.
6. The "Probe wash parameters" screen appears:

Probe wash parameters			
Wash volume (uL)		0.0	
Left Syringe fill speed:		4	
Left Syringe dispense speed:		4	
SELECT item to edit-ACCEPT if complete			
SELECT	ESCAPE	ACCEPT	

7. Enter fill and dispense speeds. The syringe automatically fills with the wash volume. However, you must use the Run/Stop key or the probe switch to complete the wash cycle.
 - If you are using a ML510B or a ML530B, you can wash the probe directly from the left syringe.
 - If you are using a ML540B, you cannot wash the right syringe or probe.

8. When you are satisfied with your entries, press ACCEPT. The system displays the “Save method in method memory” screen. Press CONFIRM to save the method, then press any key to continue.

Creating a Titrate Method

Use this function to create a titrate method. A titrate method performs the following functions:

- Fill the left and/or right syringes.
- Dispense an initial volume(s) from the syringe(s).
- Dispense step volume(s) from the syringe(s).

★ **Note: A titrate method is an interactive method that requires user input each time it is run. For example, you determine whether or not to perform the next step of the method, based on your observations of the previous dispensation. Since all titration methods are interactive, you cannot copy a titration method to a custom method or download a titration method to the drive unit. ★**

1. Follow steps 1–8 under “Creating a New Method.” Select the “Titrate method” function from the “Method type to create” menu. The “Titrate” screen appears:

Titrate		
	Left	Right
Fill volume (uL):	2500.0	250.0
Initial volume (uL):	0.0	0.0
Step volume (uL):	2.5	0.25
SELECT item to edit-ACCEPT if complete		
	SELECT	ESCAPE
	ACCEPT	

2. Enter a fill volume. The default volume is that of the installed syringe.
 - The fill volume must at least equal the initial volume plus one step.
 - The fill volume for at least one syringe must be greater than zero (0).
3. Enter an initial volume. The initial volume may be zero, less than the step volume, or greater than the step volume. Generally, however, initial volume is greater than the step volume.
4. Enter a step volume. This volume must be larger than zero (0) for at least one syringe.
5. The “Titrate method parameters” screen appears:

Titrate method parameters				
	Left	Right		
Syringe fill speed:	4	2		
Initial dispense speed:	4	2		
Step dispense speed:	8	8		
Step auto-repeat delay:		0.3		
SELECT item to edit-ACCEPT if complete				
	SELECT	ESCAPE	ACCEPT	

6. Enter syringe fill speed(s).
7. Enter initial dispense speed(s).
8. Enter step dispense speed(s).
9. Enter a step auto-repeat delay; this is the time delay between two dispensations when you press the probe button or the Run/Stop key. Valid values are from 0–60 seconds.
10. When you are satisfied with your entries, press ACCEPT. The “Save method in method memory” screen. Press CONFIRM to save the method, then press any key to continue.

Creating a Custom Method

Use this function to create a custom method of your own design.

- You may enter up to 50 command lines; any command line may be executed either manually or automatically. If you execute commands automatically, you may delay the execution of each line by 0–60 seconds, in increments of 0.1 seconds.
- Valid syringe operation modes are listed in the following table:

F ill	Fills or picks up liquid from the valve input port (typically, this is from the reservoir via the diluent syringe).
R eturn	Dispenses or returns liquid to the valve input port.
A spirate	Aspirates or picks up liquid from the output port.
D ispense	Dispenses liquid to the valve output port.

- ★ **Note:** On MICROLAB 530 instruments (D-type syringes, right side only), Fill and Aspirate perform the same function. Also, Return and Dispense perform the same function. ★
- You can create a custom method to run a valve without moving the attached syringe if you set the appropriate volume to zero or if you do not enter a volume for the syringe.
1. Follow steps 1–8 under “Creating a New Method.” Select the “Custom method” function from the “Method type to create” menu. The “Custom method” screen appears. Use the arrow keys to move from field to field. You may enter values in any order.

Custom method				
Auto Dly Vol---LEFT-Spd Vol--RIGHT-Spd				
1:				
2:				
3:				
4:				
5:				
6:				
SELECT item to edit-ACCEPT if complete				
	SELECT	ESCAPE	ACCEPT	DELETE

2. Auto field: Valid modes are Y or N, indicating that AUTO delay is either on or off. If the Auto field is blank, AUTO delay is off.
3. DLY (Delay) field. Enter the number of seconds of delay between method steps. If the Delay field is left blank, there is no delay between method steps.
4. Vol--LEFT field:
 - Use the arrow keys to set the mode of the left syringe. Valid modes are: Fil (Fill), Asp (Aspirate), Dis (Dispense), and Ret (Return fluid to the reservoir).
 - Enter a volume for the left syringe. If the Volume field is left blank, syringe volume is assumed to be 0.
5. Spd (Speed) field: Enter a speed for the left syringe from 1 to 250 seconds. Speed must be entered in whole seconds. If the Speed field is left blank, the default speed for the syringe is used.
6. Vol--Right field:
 - Use the arrow keys to set the operation mode of the right syringe. Valid modes are: Fil (Fill), Asp (Aspirate), Dis (Dispense), and Ret (Return fluid to the reservoir).
 - Enter a volume for the right syringe. If the Volume field is left blank, syringe volume is assumed to be 0.

7. Spd (Speed) field: Enter a speed for the right syringe from 1–250 seconds. The speed must be entered in whole seconds. If the Speed field is left blank, the default speed for the syringe is used.
8. Continue adding entries, creating up to 50 lines of commands.
9. When you are satisfied with your entries, press ACCEPT. The controller displays the “Save method in method memory” screen. Press CONFIRM to save the method, then press any key to continue.

Running an Existing Method

Use this function to run an existing method. At least one method must exist in the method storage area for you to use this function. If no method exists, displays a “Method Memory Empty” error message.

1. From the Main menu, SELECT the “Run an existing method” function. The following screen appears:

Run an existing method			
NEW1	NEW2	NEW3	
<UNUSED>	<UNUSED>	<UNUSED>	
<UNUSED>	<UNUSED>	<UNUSED>	
<UNUSED>	<UNUSED>	<UNUSED>	
<UNUSED>	<UNUSED>	<UNUSED>	
<UNUSED>	<UNUSED>	<UNUSED>	
<UNUSED>	<UNUSED>	<UNUSED>	
SELECT an existing method			
	SELECT	ESCAPE	

2. Use the arrow keys to highlight a method name, then press SELECT. (You cannot SELECT an unused method location.)

3. A screen verifying whether or not the correct syringes are installed appears:

Method type: Methodname				
This method requires the following syringe size(s) to be installed on the drive unit.				
Left Syringe size (uL): 2500.0				
Right Syringe size (uL): 250.0				
CONFIRM to continue, ESCAPE to exit				
		ESCAPE	CONFIRM	

4. The “Drive unit initialization” screen appears. You must respond to this screen before running the method.

Drive unit initialization				
Any fluid in the syringes on the drive unit will now be purged. Please ensure the probe is directed towards a waste area.				
CONFIRM to continue, ESCAPE to exit				
		ESCAPE	CONFIRM	

5. The contents of the selected method appears on-screen. Follow the on-screen instructions to run the method.

Editing an Existing Method

Use this function to edit an existing method. At least one method must exist in the method storage area for you to use this function.

1. From the Main menu, **SELECT** the “Edit an existing method” function. If at least one method exists, the following screen appears:

Edit an existing method				
NEW1		NEW2		NEW3
<UNUSED>		<UNUSED>		<UNUSED>
<UNUSED>		<UNUSED>		<UNUSED>
<UNUSED>		<UNUSED>		<UNUSED>
<UNUSED>		<UNUSED>		<UNUSED>
<UNUSED>		<UNUSED>		<UNUSED>
<UNUSED>		<UNUSED>		<UNUSED>
SELECT an existing method				
	SELECT	ESCAPE		

2. Use the arrow keys to highlight an existing method, then press **SELECT**. (You cannot highlight an unused method.)
 3. The contents of the selected method appears on-screen. Use the arrow keys to highlight the field you wish edit, then press **SELECT**. The highlighting changes to underlining. Use the arrow keys or the numeric keypad to change the underlined value. When you are satisfied with your edit, press **ENTER** to accept the new value.
 4. **SELECT** another field to edit or press **ACCEPT** to save all changes made to the method and return to the “Edit an existing method” screen. **SELECT** another method to edit or press **ESCAPE** to return to the Main menu.
- * Note: Syringe size or configuration cannot be edited from this screen. ***

Performing Manual Dilutions

Use the Manual Dilution function to perform manual dilutions without creating and saving a new dilution method, or without running an existing dilution method. Manual dilutions cannot be stored in memory.

1. From the Main menu, select the “Manual dilution” function. The “Instrument configuration” screen appears:

Instrument configuration				
One syringe instrument				
Two syringe instrument				
SELECT menu item				
	SELECT	ESCAPE		

2. Use the arrow keys to highlight either a one- or a two-syringe instrument configuration, then press SELECT.
3. The default value(s) for the selected configuration appear on-screen.

Instrument configuration				
One syringe instrument				
Two syringe instrument				
Left Syringe size (uL): 2500.0				
Right Syringe size (uL): 250.0				
SELECT item to edit-ACCEPT if complete				
	SELECT	ESCAPE	ACCEPT	

4. Press ACCEPT to retain the default sizes.
5. To change a syringe's size, use the arrow keys to highlight the appropriate size, then press SELECT. The highlighting changes to underlining. Use the arrow keys to increase or decrease syringe size. Press ENTER to accept the new size. When you are satisfied with the syringe sizes, press ACCEPT.
6. The "Manual dilution" screen appears. The following sample screen shows a two-syringe instrument:

Manual dilution		
	Left	Right
Syringe speed:	<u>4</u>	2
• Fill volume (uL):	2500.0	
Aspirate volume (uL):	0.0	250.0
Dispense volume (uL):	0.0	0.0
SELECT item to edit-RUN to start		
	SELECT	ESCAPE
		MODE

7. Enter syringe speed(s).
 - Enter a fill volume for the left syringe.
 - Enter an aspiration volume for the left and right syringes.
 - You cannot enter a value for Dispense volume.
Dispense volume = Fill volume + Aspirate volumes.
8. Press CONFIRM.
9. Press the Run/Stop key to start the manual dilution method. The dot in the left margin moves to indicate the active mode. Press MODE for manual dilution editing options.
10. Press ESCAPE to exit the method and return to the main menu.

Performing Manual Dispenses

Use the Manual Dispense function to perform manual dispensations without creating and saving a new dispense method, or without running an existing dispense method. Manual dispenses cannot be stored in memory.

1. From the Main menu, select the “Manual dispense” function. The “Instrument configuration” screen appears:

Instrument configuration				
One syringe instrument				
Two syringe instrument				
SELECT menu item				
	SELECT	ESCAPE		

2. Use the arrow keys to highlight either a one- or a two-syringe instrument configuration, then press SELECT.
3. The default value(s) for the selected configuration appear:

Instrument configuration				
One syringe instrument				
Two syringe instrument				
Left Syringe size (uL): 2500.0				
Right Syringe size (uL): 250.0				
SELECT item to edit-ACCEPT if complete				
	SELECT	ESCAPE	ACCEPT	

4. Press ACCEPT to retain the default sizes.
5. To change a syringe's size, use the arrow keys to highlight the size, then press SELECT. The highlighting changes to underlining. Use the arrow keys to increase or decrease syringe size. Press ENTER to accept the new size; the previous screen appears. When you are satisfied with the syringe sizes, press ACCEPT.
6. The "Manual dispense" screen appears:

Manual dispense			
	Left	Right	
Syringe speed:	<u>4</u>	2	
• Fill volume (uL):	2500.0	250.00	
Dispense volume (uL):	2500.0	250.00	
SELECT item to edit-RUN to start			
	SELECT	ESCAPE	MODE

7. Enter syringe speed(s).
 - Enter a fill volume for the left and right syringes.
 - Enter a dispense volume for the left and right syringes.
8. Press CONFIRM.
9. Press the Run/Stop key to start the manual dispense method. The dot in the left margin moves to indicate the active mode. Press MODE for manual dispense editing options.
10. Press ESCAPE to exit the method and return to the Main menu.

The following screen shows the contents of the Utilities menu:

Utilities menu				
Rename an existing method				
Delete an existing method				
Copy a method to a custom method				
Download a method to the drive unit				
Diagnostic and configuration menu				
SELECT menu item				
	SELECT	ESCAPE		

Use the arrow key to highlight the desired utility function, then press SELECT to accept the choice or press ESCAPE to return to the Main menu.

Renaming an Existing Method

Use this function to rename an existing method. At least one method must exist in the method storage area for you to use this function. If no method exists, receive “Method memory empty” error.

1. From the Utilities menu, SELECT the “Rename an existing method” function. The “Rename an existing method” screen appears:

Rename an existing method				
	NEW1	NEW2	NEW3	
	<UNUSED>	<UNUSED>	<UNUSED>	
	<UNUSED>	<UNUSED>	<UNUSED>	
	<UNUSED>	<UNUSED>	<UNUSED>	
	<UNUSED>	<UNUSED>	<UNUSED>	
	<UNUSED>	<UNUSED>	<UNUSED>	
	<UNUSED>	<UNUSED>	<UNUSED>	
	SELECT an existing method			
	SELECT	ESCAPE		

2. SELECT an existing method.
3. The following screen appears:

Rename an existing method				
1 2 3 4 5 6 7 8 9 -				
Q W E R T Y U I O P				
A S D F G H J K L				
Z X C V B N M				
SPACE				
Name: <u>New1</u>				
SELECT next letter-ACCEPT if complete				
SELECT	ESCAPE	ACCEPT	DELETE	

- To accept a character, press SELECT.
 - To erase a character, press DELETE.
 - Press ESCAPE to return to the main menu without renaming the existing method.
 - Press ACCEPT when you are finished naming the new method.
4. When you are satisfied with your entries, press ACCEPT. The “Save method in method memory” screen. Press CONFIRM to save the renamed method in memory, then press any key to continue.

Deleting an Existing Method

Use this function to edit an existing method. At least one method must exist in the method storage area for you to use this function. If no method exists, you receive an error message.

1. From the Utilities menu, **SELECT** the “Delete an existing method” function. The “Delete an existing method” screen appears:

Delete an existing method		
NEW1	NEW2	NEW 3
<UNUSED>	<UNUSED>	<UNUSED>
<UNUSED>	<UNUSED>	<UNUSED>
<UNUSED>	<UNUSED>	<UNUSED>
<UNUSED>	<UNUSED>	<UNUSED>
<UNUSED>	<UNUSED>	<UNUSED>
<UNUSED>	<UNUSED>	<UNUSED>
CONFIRM to delete, ESCAPE to cancel		
	SELECT	ESCAPE

2. Use the arrow keys to select an existing method. The valid functions change to **ESCAPE** and **CONFIRM**.
3. Press **CONFIRM** to delete the method. Returns to the “Delete an existing method” screen. **SELECT** another method to delete or press **ESCAPE** to return to the Utilities menu.

Copying a Method to a Custom Method

Use this function to copy an existing method into a custom method.

- At least one method must exist in the method storage area for you to use this function. If no method exists, you receive an error message.
 - You cannot copy a titration method to a custom method, since titration methods are interactive.
1. From the Utilities menu, **SELECT** the “Copy a method to a custom method” function. The “Method to copy to custom” screen appears:

Method to copy to custom				
NEW1	NEW2	NEW3		
<UNUSED>	<UNUSED>	<UNUSED>		
<UNUSED>	<UNUSED>	<UNUSED>		
<UNUSED>	<UNUSED>	<UNUSED>		
<UNUSED>	<UNUSED>	<UNUSED>		
<UNUSED>	<UNUSED>	<UNUSED>		
<UNUSED>	<UNUSED>	<UNUSED>		
SELECT an existing method				
	SELECT	ESCAPE		

2. **SELECT** the method you wish to copy.
3. The “Custom method to be created” screen appears:

Custom method to be created				
NEW1	NEW2	NEW3		
<UNUSED>	<UNUSED>	<UNUSED>		
<UNUSED>	<UNUSED>	<UNUSED>		
<UNUSED>	<UNUSED>	<UNUSED>		
<UNUSED>	<UNUSED>	<UNUSED>		
<UNUSED>	<UNUSED>	<UNUSED>		
<UNUSED>	<UNUSED>	<UNUSED>		
SELECT an UNUSED method				
	SELECT	ESCAPE		

4. SELECT any <unused> method.
5. The following screen appears:

Custom method to be created				
1 2 3 4 5 6 7 8 9 -				
Q W E R T Y U I O P				
A S D F G H J K L				
Z X C V B N M				
SPACE				
Name: _____				
SELECT next letter-ACCEPT if complete				
SELECT	ESCAPE	ACCEPT	DELETE	

6. Use the arrow keys to spell out the name of the new custom method.
 - To accept a character, press SELECT.
 - To erase a character, press DELETE.
 - Press ESCAPE to return to the main menu without copying an existing method.
 - Press ACCEPT when you are finished naming the new method.
7. When you are satisfied with your entries, press ACCEPT. The “Save method in method memory” screen. Press CONFIRM to save the new method, then press any key to continue.

Downloading a Method to the Drive unit

Use this function to download a method from the controller unit to the drive unit. The drive unit can execute a downloaded method only when the controller unit is disconnected. Also, the power must be cycled off then on after the method is downloaded. Use a hand probe button or a foot activator switch to execute downloaded methods.

*** Note: Each time a method is downloaded, the previously downloaded method is erased. ***

- At least one method must exist in the controller method storage area for you to use this function. If no method exists, you receive an error message.
 - You cannot download a titration method, since titration methods are interactive.
1. From the Utilities menu, SELECT the “Download a method to the drive unit” function. The “Download a method” screen appears:

Download a method			
NEW1	NEW2	NEW3	
<UNUSED>	<UNUSED>	<UNUSED>	
<UNUSED>	<UNUSED>	<UNUSED>	
<UNUSED>	<UNUSED>	<UNUSED>	
<UNUSED>	<UNUSED>	<UNUSED>	
<UNUSED>	<UNUSED>	<UNUSED>	
SELECT an existing method			
	SELECT	ESCAPE	

2. Select the method you wish to download, then press SELECT.
3. The “Download a method” screen appears:

Download a method: NEW2			
The method selected will be down- loaded to the drive unit.			
CONFIRM to start, ESCAPE to exit			
		ESCAPE	CONFIRM

4. Press CONFIRM to download the method.
5. A message appears confirming that the download is complete. Press any key to return to the Utilities menu.

Diagnostic and Configuration Menu

Use the functions under the Diagnostic and Configuration menu to diagnose system problems and to change the instrument's configuration.

Diagnostic and configuration menu				
Change default language				
Set baud rate to drive unit				
Turn caps lock on/off				
Perform display test				
Perform keyboard test				
Set diagnostic mode				
SELECT menu item				
	SELECT	ESCAPE		

Changing the Default Language

Use this function to change the language that system messages display in.

1. From the Diagnostics and Configuration menu, SELECT the “Change default language” function. The following screen appears:

Change default language				
English				
Francais				
Deutsch				
Português				
Español				
Clear default language				
SELECT menu item				
	SELECT	ESCAPE		

2. To change the default language, **SELECT** one of five valid languages:
 - English
 - French (Français)
 - German (Deutsch)
 - Portuguese (Português)
 - Spanish (Español)
 3. To be prompted for a new language upon instrument startup, **SELECT** the “Clear default language” function.
 4. Press **ESCAPE** to return to the Diagnostics and Configuration menu.
- ★ **Note:** Some versions of the **ML500B** are shipped with English as the only language option. No other language options are available on these instruments. ★

Setting the Baud Rate to the Drive Unit

Use this function to change the baud rate setting of the drive unit.

- For the controller to communicate with the drive unit, the baud rates of both must be the same.
 - See “Setting Communications Options” in Chapter 2 for information about changing the baud rate on the drive unit.
1. From the Diagnostics and Configuration menu, **SELECT** the “Set baud rate to drive unit” function. The “Set baud rate to drive unit” screen appears:

Set baud rate to drive unit			
1200			
2400			
9600			
4800			
19,200			
38,400			
SELECT menu item			
SELECT	ESCAPE		

2. SELECT a baud rate, then press ESCAPE to return to the Diagnostics and Configuration menu.

Turning Caps Lock On and Off

This function toggles the display text between mixed upper-and-lower case characters to ALL CAP characters.

From the Diagnostics and Configuration menu, SELECT “Turn caps lock on/off.” This function does not display a screen, but automatically changes text displayed on the screen from ALL CAP characters to mixed upper-and-lower case characters, or vice versa.

Performing the Display Test

Use this function to test the display screen. This function is for use by qualified service personnel.

From the Diagnostics and Configuration menu, SELECT “Perform display test.” The test screen. Press any key except 1, 2, 3, or Run/Stop to exit the test mode. Keys 1, 2, 3, and Run/Stop perform various display tests.

Performing the Keyboard Test

Use this function to test the keyboard area of the unit. This function is for use by qualified service personnel.

From the Diagnostics and Configuration menu, SELECT “Perform keyboard test”. The keyboard test screen appears. Press escape twice to exit the test mode.

Sample MICROLAB 510B Application Configurations

Single Syringe Dispensing

When the probe button is pressed once, fluid is pulled from the reservoir into the TLL syringe. The valve then switches to connect the fluid path from the TLL syringe to the hand probe.

When the probe button is pressed a second time, liquid is dispensed out of the probe tip. Figure 3-5 shows the Concorde Probe being used for single syringe dispensing.

Figure 3-6 Single Syringe Dispensing

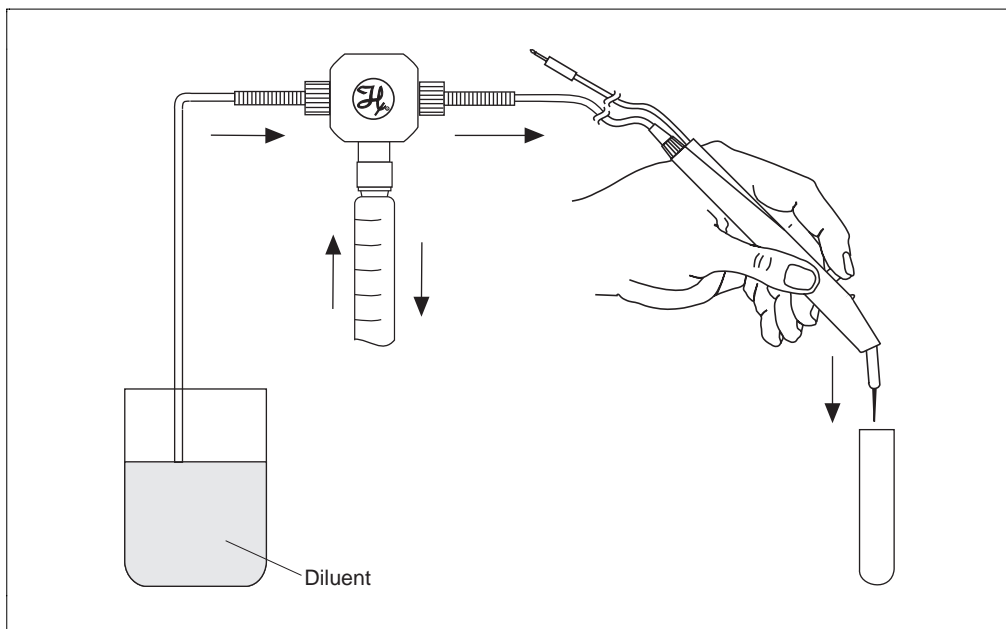

Sample MICROLAB 530B Application Configurations

Example 1: Dilutions

When the probe button is pressed once, the syringe drive arms move down, pulling diluent in from the reservoir, and aspirating sample into the probe tip. Then, the valve reverses and connects the fluid path from both syringes to the hand probe.

When the probe button is pressed a second time, the syringe drive arms move up. Sample and diluent are dispensed and mixed together, creating a dilution.

Figure 3-6 shows the Disposable Tip Probe being used for dilutions.

Figure 3-7 Dilutions

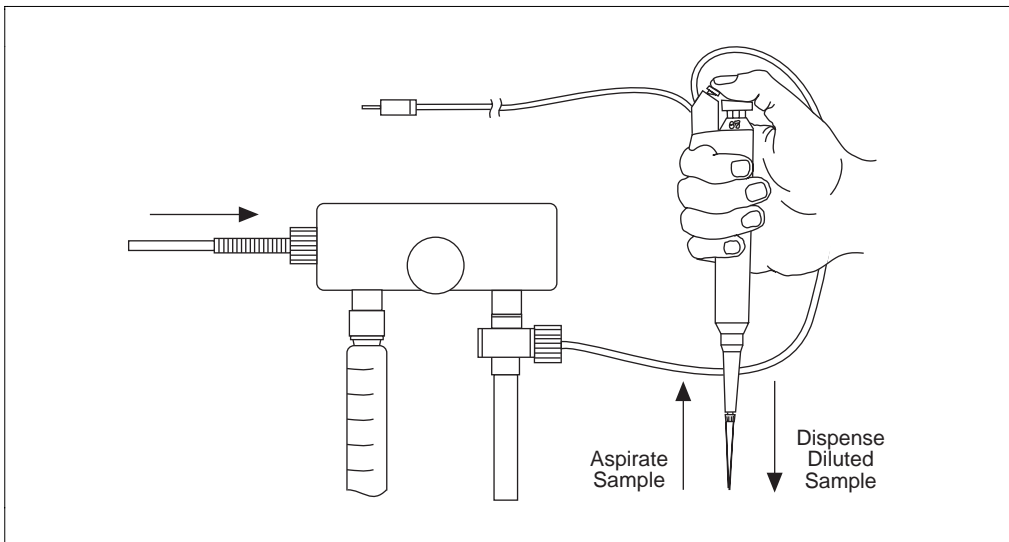

Example 2: Dilutions

MICROLAB 530B Example 2 follows the same procedures as those shown in the MICROLAB 530B Example 1, except that two TLL syringes are used and the dispense tubing is connected directly to the side of the valve assembly. To attach tubing directly to the valve assembly, remove the plug on the side of the valve. Replace the plug with tubing. Figure 3-7 shows the Concorde Hand Probe being used for serial dilutions.

Figure 3-8 Serial Dilutions

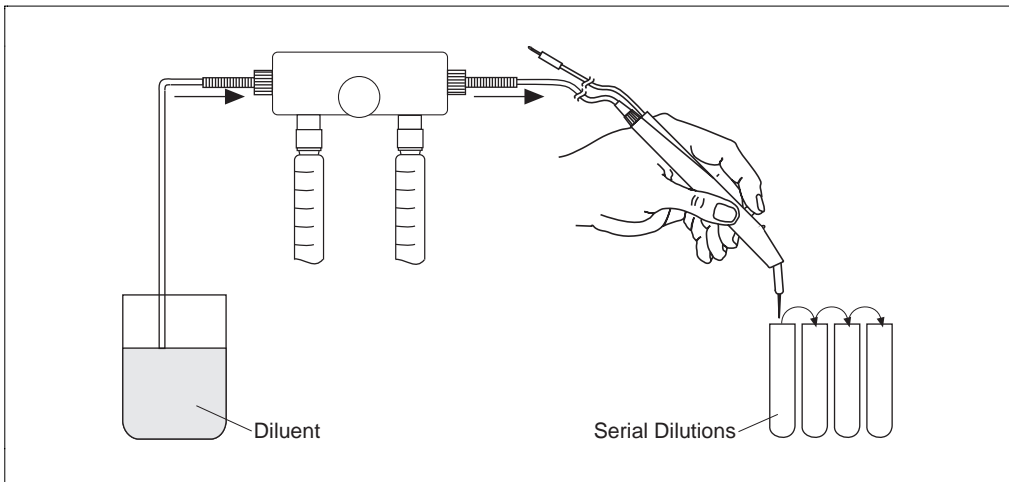

Sample MICROLAB 540B Application Configurations

Example 1: Dual Dispensing

When the probe button is pressed once, the syringe drive arms move down, pulling in two different liquids from two different reservoirs. The valves then reverse and connect the fluid path from the syringes to the hand probe.

When the probe button is pressed a second time, the syringe drive arms move up, dispensing the two liquids out of separate tubing lines. Figure 3–8 shows the Dual Hand Probe being used for dual dispenses.

Figure 3–9 Dual Dispensing

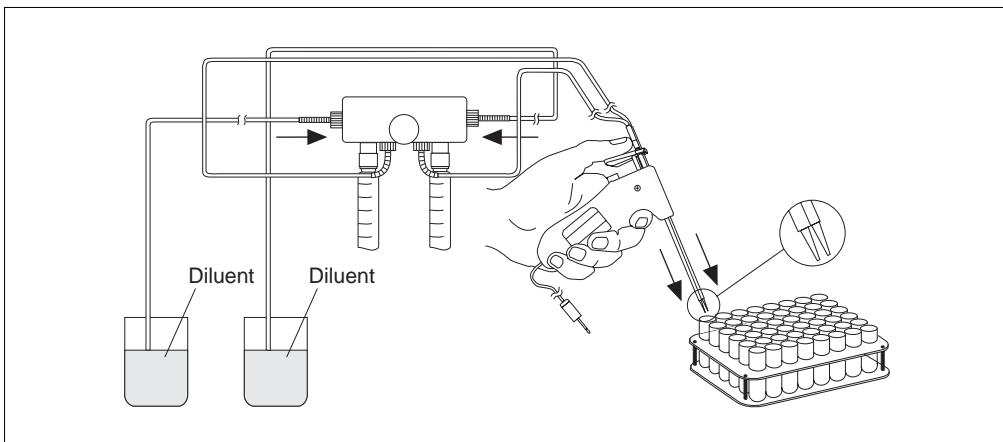

Example 2: Using the Dual Dispenser for Single Dispensing

MICROLAB 540B Example 2 follows the same procedures as those shown in the MICROLAB 540B Example 1, except that liquid is dispensed out of the right side only. On the left side, a liquid is cycled from the reservoir, through the fluid path, and back again simply to lubricate the fluid path. Figure 3–9 shows the Concorde Hand Probe being used for single dispensing.

Figure 3–10 Using the Dual Dispenser for Single Dispensing

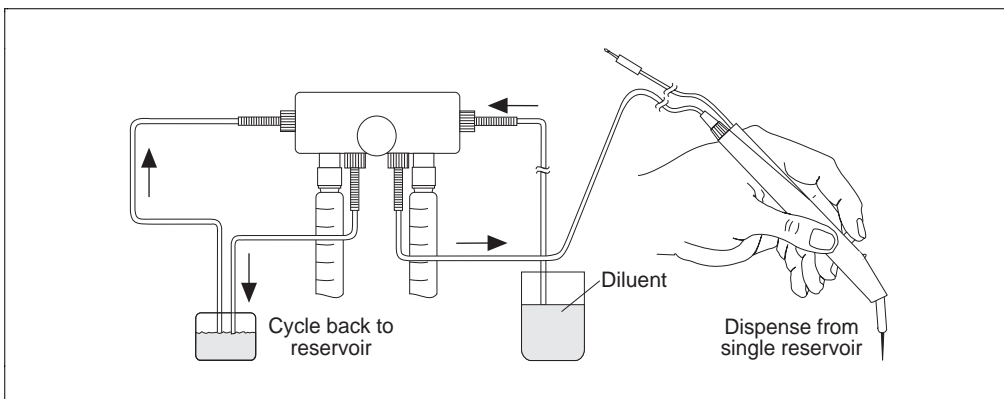

- ★ **Note:** After the syringe size is set, the right or left syringe can remain idle if the fill and the dispense volume for that syringe is set to 0 (zero). Do not operate either syringe dry, as this may cause excessive wear on the syringes and valves. ★

Chapter 4 Caring for the MICROLAB 500

This chapter contains instructions on routine maintenance procedures for the MICROLAB 500, including the following topics:

- deciding when to clean the MICROLAB 500
- cleaning the fluid path
- cleaning syringes and tubing
- cleaning the exterior of the system
- storing the system
- chemical compatibility of the system
- replacing batteries while saving stored methods

★ **Note: Call Hamilton Company's Technical/Customer Service Department at (800) 648-5950 (in the United States and Canada) if you have questions about maintaining your MICROLAB 500 system. ★**

Deciding When to Clean the MICROLAB 500

How often you clean the MICROLAB depends upon how you use the instrument and what you use in it.

We recommend that, if you use the instrument daily, the tubing and syringes should be purged and primed at the end of each experiment and each work shift. Clean the system by flushing it with Hamilton Syringe Cleaner, ethanol, or a with a 10% chlorine bleach and deionized water solution. Avoid using caustic or acidic cleaning solutions.

▲ Important Leave the syringes and tubing filled with deionized water overnight. This is important if you are using buffers or other salt solutions which could accumulate or crystallize in the system. If buffers or other salt solutions are left in the fluid path overnight, crystals may form and damage the syringe plunger tip. ▲

See “Cleaning the Fluid Path of MICROLAB 500” for complete details on cleaning the fluid path. If you still have questions, contact Hamilton Company’s Technical/Customer Service Department at (800) 648-5950.

Cleaning the Fluid Path of the MICROLAB 500

Clean the MICROLAB 500’s fluid path before using it for the first time. Use Hamilton Syringe Cleaning Solution to clean the fluid path. See Appendix C for information on ordering Hamilton Syringe Cleaner.

To clean the fluid path, follow these steps:

1. Prepare a reservoir of cleaning fluid and place the fill tubing in the cleaning fluid reservoir. Use a tubing clip to secure the tubing to the side of the reservoir.
2. Place the hand probe into the cleaning fluid reservoir or a waste container.

3. Press the Step/Prime switch on the drive unit to start the priming cycle.
 4. Continue the priming cycle until the fluid path is clean. The number of cycles needed to clean the fluid path will depend on the sizes of the syringes and the dirtiness of the system.
 5. When the fluid path is clean, press the Step/Prime switch back to the middle position to stop the priming cycle.
 6. Move the inlet tubing from the cleaning fluid reservoir and place it into a reservoir of deionized water.
 7. Press the Step/Prime switch to continue the priming cycle.
 8. Continue the priming cycle until the fluid path is free of all cleaning fluid. Dispense the rinse fluid into a waste reservoir.
 9. Press the Step/Prime switch to the inactive position to stop the priming cycle.
 10. Press the Step/Prime switch to the Step position and advance the syringe drive arm to the Home position.
 11. The system is now clean and ready for use.
- ★ **Note:** When priming reagent after a deionized water rinse, dispense the first shot into a waste container, since it will contain a certain amount of the water droplets that remained in the tubing line. ★

Cleaning Syringes and Tubing



Warning! Follow your laboratory's safety procedures if you use the MICROLAB 500 system to handle hazardous materials. ⚠

When tubing and syringes come in contact with contaminated or hazardous samples, follow safe laboratory practices in selecting and using a cleaning fluid to flush out the tubing and syringes. Purge, clean, and decontaminate the MICROLAB 500 by thoroughly flushing out all portions of the tubing and syringes.

Use a cleaner that is compatible with the fluids previously run through the system. Depending on the sample that is being run, you may want to use de-ionized water, urea, ethanol, or a 10% chlorine bleach and deionized water solution as a cleaning fluid.

Clean syringe plunger tips by soaking them in Hamilton Syringe Cleaning Solution. If you still have questions, contact Hamilton Company's Technical/Customer Service Department at (800) 648-5950 (in the United States and Canada).

Cleaning the Exterior of the MICROLAB 500



Warning! Follow your laboratory's safety procedures if you use the MICROLAB 500 system to handle hazardous materials. ⚠

The MICROLAB 500 housing is moderately inert to chemical exposure. However, some chemicals may discolor the surface of the unit.

If a spill occurs on the instrument's exterior, wipe the surface immediately. Wash the surface using a damp cloth with water and soap **or** use a SANI-CLOTH™. Then dry the area. Take care that liquids do not enter the interior of the MICROLAB 500.

To disinfect the exterior surface, wipe it down with a 10% chlorine bleach and deionized water solution. Then dry the area.

- ★ **Note: The cleaning guidelines presented here are meant as guidelines only. If your particular applications require different cleaning solutions, contact Hamilton Company for more information. ★**

Chemical Compatibility

The MICROLAB 500's fluid path consists of PTFE-based materials and borosilicate glass. These materials are resistant to a wide variety of acids and bases at room-to-moderate temperatures. Most chemicals do not affect PTFE at normal operating temperatures.

- ▲ **Important Do not use the MICROLAB 500 for prolonged periods at high temperatures with aromatic or highly halogenated compounds. These compounds may cause the MICROLAB 's fittings to swell, adversely affecting performance and reducing the life of system components. Appendix D, Chemical Compatibility of the MICROLAB 500, provides a list of chemicals and their compatibility with the MICROLAB 500 system. ▲**

If you have any questions about chemical resistance to specific compounds, please contact the Hamilton Company; check out any unusual or reactive compounds before using them with your MICROLAB 500 system.

Storing the MICROLAB 500

For long-term storage, prime and purge the system with methanol to facilitate drying. Remove the tubes and syringes. Cover the instrument to protect it from damage. Store syringes in their original containers.

Replacing Batteries

You can replace the batteries in the MICROLAB 500 and yet save all methods stored in memory. To change batteries while saving stored methods, follow these instructions:

▲ **Important** Read all the following instructions before replacing batteries. You **MUST** follow these steps to save stored methods. ▲

1. Make sure the controller is plugged into the base unit. The controller **must** remain plugged into the base unit to save stored methods.
2. Make sure the base unit is powered on. The base unit **must** remain powered on to save stored methods.
3. Turn over the controller. Remove the single screw from the battery cover and set the cover and screw aside.
4. Pull out the two old batteries and replace them with two new AA batteries. Be sure to match the positive-negative symbols on the batteries and on the controller.

▲ **Important** Make sure you install the batteries correctly, according to the positive and negative symbols. If you reverse the batteries' positions and power off the base unit, all stored methods will be lost. ▲

5. Replace the battery cover and secure it with the screw.
6. You may now power the instrument off, if desired.

Chapter 5 Troubleshooting the MICROLAB 500

This chapter contains information about the following topics:

- message codes
- troubleshooting
- technical support
- returning instruments for repair

Please read this chapter; some problems may be easily resolved by using the information found in the message code and troubleshooting guides.

Error Message Code Guide

The MICROLAB 's display windows provide you with system status and with error message information.

If an error occurs, an error message appears, the system beeps three times, and all operation and function keys are disabled. To recover from the error, reinitialize the system by pressing the Run/Stop key. You cannot use the probe button on a hand probe to reinitialize the system.

Table 5-1 lists the error messages that may appear on the screen.

Table 5-1 Error Message Code Guide

Error Type	Error Message
Battery Errors	
battery failure	The battery used to preserve stored methods has either run too low to preserve the stored methods, or there is no battery installed. Any methods that have been stored on this unit have been lost.
battery low	The battery used to preserve stored methods is running low. Replace the battery soon to prevent loss of stored methods.
Communication Errors	
communication	The communication link to the drive unit could not be established. Check that the connection to the drive unit is good and that the protocol and baud rate settings are correct. Also try cycling power on the drive unit. Then try the operation again.
communication invalid echo	The echo received from the drive unit was not correct. Consult the user's manual to ensure the cable, loopback switch, protocol switch, and baud rate switches are set correctly.

continued

Table 5-1 Error Message Code Guide (continued)

Error Type	Error Message
Communication Errors	
communication invalid length	The drive unit responded to the last command with either too little or too much data. Consult the user's manual to ensure the cable, loopback switch, protocol switch, and baud rate switches are set correctly.
communication NAK response	The drive unit did not accept the last command sent to it. Ensure that the Step/Prime switch is off, and the cable, loopback switch, protocol switch, and baud rate switches are set correctly.
communication receive time-out	A serial I/O character was not received within the expected amount of time. Consult the user's manual to ensure the cable, loopback switch, protocol switch, and baud rate switches are set up properly.
communication transmit	A physical serial I/O error occurred while attempting to send a command to the drive unit. This problem should be reported to your dealer.
communication invalid character	An invalid response was received from the drive unit for the last command sent. Consult the user's manual to ensure the cable, loopback switch, protocol switch, and baud rate switches are set correctly.
Custom Method Errors	
copy method to custom method	A titrate method cannot be copied to a custom method. All other method types may be converted to a custom method.
custom method is empty	At least one operation must be specified in a custom method before the method can be accepted.

continued

Table 5-1 Error Message Code Guide (continued)

Error Type	Error Message
Custom Method Errors	
custom method over-aspirate	This method will not operate as expected because more volume has been aspirated or filled than will fit in the syringe.
custom method over-dispense	This method will not operate as expected because more volume has been dispensed than has been filled or aspirated.
custom method under-dispense	This method may not operate as expected because more volume has been aspirated or filled than has been dispensed.
Delay Time Errors	
delay time range	The delay time entered is not allowed on this unit. The valid delay times appear on the bottom of the screen while the delay time is being entered.
delay time resolution	The delay time entered exceeds the delay time resolution allowed by this unit. The valid delay time resolution appears on the bottom of the screen while the delay time is being entered.
Dilution Errors	
dilute method	The dilution or ratio and a volume, or any 2 volume values must be entered for a dilution method.
dilution parameters	The dilution specified cannot be achieved using the syringe size(s) configured. Try one of the following: <ol style="list-style-type: none"> 1. Use different dilution values. 2. Use different sized syringes. 3. Consult the user's manual to determine appropriate values.

continued

Table 5-1 Error Message Code Guide (continued)

Error Type	Error Message
Dilution Errors	
dilution ratio	A dilution of one or a ratio of zero cannot be accomplished. A dilution greater than one or a ratio greater than zero must be used.
dilution volume	A dilution cannot be performed when any of the dilution volumes is zero. Dilution volumes of greater than zero must be used.
Dispense Errors	
aliquots to dispense	The number of aliquots entered is greater than the maximum number of aliquots allowed for the syringe size(s) and volume(s) configured.
no aliquot dispense volume	An aliquot dispense method requires at least one non-zero aliquot volume to be specified.
no pipette dispense volume	A pipette method requires that a dispense volume to be specified is greater than zero.
no serial dispense volume	A serial dispense method requires at least one dispense from at least one syringe to be performed.
Drive Unit Errors	
drive unit busy	The operation requested cannot be performed because the drive unit is currently busy. Either wait until the drive unit is no longer busy, or cycle its power. Then try the operation again.
drive unit delay configuration	This drive unit currently attached is not capable of performing one or more of the delays specified in the method. Refer to the user's manual to determine the speeds supported by this drive unit.

continued

Table 5-1 Error Message Code Guide (continued)

Error Type	Error Message
Drive Unit Errors	
drive unit download configuration	This drive unit either does not have the appropriate number of valves and/or syringes to operate this method, or is not capable or running this method. Refer to the user's manual for more information.
drive unit download	This drive unit is either unable to store any methods or is not compatible with this controller. Refer to the user's manual for more information
drive unit download titrate method	A titration method is an interactive method and, as such, cannot be downloaded to the drive unit. All other types of methods are not interactive and may be downloaded to the drive unit.
drive unit Step/Prime busy	This operation cannot be performed because the drive unit is currently in Step/Prime mode. Turn the Step/Prime switch off and wait for the unit to stop, then try the operation again.
drive unit initialization	This operation requested cannot be performed because the drive unit was unable to successfully complete its initialization sequence. Check that all valves and syringes are properly attached. Then try the operation again.
drive unit over temperature	This method cannot be completed because the drive unit is too warm. The method may be restarted after the drive unit has cooled sufficiently.
drive unit over temperature	This operation cannot be performed because the drive unit is too warm. This operation can continue after the drive unit has cooled sufficiently.

continued

Table 5-1 Error Message Code Guide (continued)

Error Type	Error Message
Drive Unit Errors	
drive unit stalled	This method cannot be completed because the drive unit has experienced a valve and/or syringe stall. The method will have to be restarted.
drive unit priming	The method cannot be completed because the drive unit is currently in Step/Prime mode. Turn the Step/Prime switch off and wait for the unit to stop. Then try the operation again.
drive unit speed range	This drive unit is not capable of operating at one or more of the speeds specified in the method. Refer to the user's manual to determine the speeds supported by this drive unit.
drive unit syringe configuration	This drive unit does not have the appropriate number of syringes to perform this method. Either change the configuration of the method or try a different method.
drive unit valve configuration	This drive unit does not have the appropriate number of valves to perform this method. Either change the configuration of the method or try a different method.
invalid/unknown drive unit	This drive unit cannot be operated by the controller. Please refer to the user's manual to determine the types of drive units that can be operated by the controller.

continued

Table 5-1 Error Message Code Guide (continued)

Error Type	Error Message
Method Errors	
duplicate method name	The method name selected cannot be used because a method with the same name already exists. Use the THE DELETE AN EXISTING METHOD selection to remove that method.
method memory cleared	The battery used to preserve methods stored on this unit is good, but any stored methods have been lost. This can be caused by battery replacement or by the first power-up of the unit.
method memory empty	The operation cannot be performed because the method memory is empty. Use the CREATE A NEW METHOD selection to create a new method.
method memory is full	A new method cannot be created because the method memory is full. Use the DELETE AN EXISTING METHOD selection to release method memory.
Priming Errors	
prime cycles range	The number of prime cycles entered is not allowed on this unit. The valid number of prime cycles appear on the bottom of the screen while the number of prime cycles is being entered.
Syringe Errors	
operation exceeds volume	This operation cannot be performed because it exceeds the limits of the syringe.
syringe speed range	The syringe speed entered cannot be achieved by this unit. The valid syringe speeds appear on the screen while the speed is being entered.

continued

Table 5-1 Error Message Code Guide (continued)

Error Type	Error Message
Syringe Errors	
syringe volume range	The syringe volume entered exceeds the volume of the syringe that has been configured. The valid syringe volumes appear on the bottom of the screen while the syringe volume is being entered.
syringe volume resolution	The syringe volume entered exceeds the resolution of the syringe that has been configured. The valid syringe resolution appears on the bottom of the screen while the syringe volume is being entered.
total syringe volume	The total volume(s) entered exceeds the volume of the syringe(s) that have been configured. Either reduce the volume(s), or use a different syringe size.
total syringe volume range	The total volume entered exceeds the volume of the syringe(s) that have been configured. The valid total volumes appear on the bottom of the screen while the total syringe volume is being entered.
Titration Errors	
titrate fill volume	The fill volume for the syringe(s) must be at least equal to the initial volume plus the step volume.
titrate step volume	A step volume greater than zero must be entered for at least one syringe.

Audible Messages

When a MICROLAB 500 system is operated via the controller unit, the system will provide audible messages—beeps, that indicate certain events. These events are listed in Table 5-2.

Table 5-2 Audible System Messages

Number of Beeps	Event
2	The system beeps twice upon power-up (at the end of power-up diagnostics).
1	The system beeps once at the start of an operation.
3	The system beeps three times if an error occurs.

Troubleshooting Guide

Table 5-3 provides quick answers to help you troubleshoot your MICROLAB 500.

Table 5–3 Troubleshooting Guide

Problem	Possible Causes	Corrective Action
instrument does not power-up	<ul style="list-style-type: none">• disconnected power cord or faulty power outlet• main fuses are blown	<ul style="list-style-type: none">• connect power cord and check power source• check main fuses on instrument's rear panel; replace fuses if necessary
instrument functions normally, but display screen fails to illuminate	<ul style="list-style-type: none">• controller unit not plugged in drive unit• faulty LCD	<ul style="list-style-type: none">• check to see that the controller unit is plugged into the drive unit• call the Hamilton Service Department

(continued)

Table 5–3 Troubleshooting Guide (continued)

Problem	Possible Causes	Corrective Action
instrument does not fill or dispense	<ul style="list-style-type: none">• faulty or blocked tubing; blocked or leaky fluid path• incorrect tubing or syringe connections• faulty keys• non-functional syringe drive(s)• valves do not rotate (valve drives are not engaged or valve is faulty)	<ul style="list-style-type: none">• check tubing, valve, and syringes for blockages, crimps, or loose fittings; replace tubing; either replace or reseal valve and syringes; tighten valve and syringes• check that appropriate tubing, fittings, and syringes are used and that they are finger-tight• call the Hamilton Service Department• call the Hamilton Service Department• remove and reseal valve; tighten thumbscrew; or replace valve

(continued)

Table 5–3 Troubleshooting Guide (continued)

Problem	Possible Causes	Corrective Action
instrument gives inaccurate or imprecise results	<ul style="list-style-type: none"> • air exists in the fluid path • incorrect size of dispense tubing used with syringe 	<ul style="list-style-type: none"> • check to see that tubing ends are totally submerged in reagent bottles • check to see that tubing connections are tight; replace if necessary • check to see that the syringe is installed correctly and that it is not leaking • replace worn or leaking valve or tubing • reduce the syringe drive speed to eliminate cavitation problems • check for correct tubing and fittings • use small tapered tubing (18-gauge) for small dispense volumes
small air gap appears at tip of probe tubing after final aspiration	<ul style="list-style-type: none"> • dirty tubing • improper aspiration 	<ul style="list-style-type: none"> • change or clean the tubing • lower the aspiration speed

(continued)

Table 5–3 Troubleshooting Guide (continued)

Problem	Possible Causes	Corrective Action
persistent air or leaks in the fluid path	<ul style="list-style-type: none">• cavitation is occurring; syringe drive speed is too high for the current liquid• loose, worn, or incorrect tubing fittings• damaged syringe plunger tip• damaged valve	<ul style="list-style-type: none">• reduce syringe drive speed, use lower drive speeds for viscous liquids• hand-tighten the fittings or replace old tubing with new or correct-size tubing• replace plunger tip or syringe• replace valve
unit is overheated	<ul style="list-style-type: none">• inadequate ventilation, room temperature too high, or duty cycle too high	<ul style="list-style-type: none">• the unit is overheated, power it off and allow it to cool down• resume use at a lower duty cycle• see Appendix A, Technical Specifications, for information about appropriate environmental conditions

Getting Technical Support

If a problem persists even after you have attempted to correct it, contact the Hamilton Company Instrument Service Department. To expedite service, please have your instrument's model and serial number ready and available. Also, please provide application-specific information (such as syringe sizes, drive speeds, and liquids).

In the United States:

Hamilton Company, P.O. Box 10030, Reno, Nevada 89520-0012

Telephone Numbers (in the USA and Canada):

Technical/Customer Service 1-800-648-5950 8 a.m. to 5 p.m. PST

Instrument Service +1-800-527-5269

Outside the USA and Canada:

+1-775-858-3000

Fax Number: +1-775-856-7259

In Switzerland:

Hamilton Bonaduz AG, Ch-7402, P.O. Box 26,

Bonaduz, Switzerland

Telephone Number: +41-81-660-60-60

Fax Number: +41-81-660-60-70

Returning Instruments for Repair

Before returning an instrument to Hamilton (Reno) for repair, notify Hamilton Company's Instrument Service Department at (800) 527-5269 (in the United States and Canada) and request a Returned Goods Authorization Number (RGA number).

✦ **Note: Do not return instruments to Hamilton Company without an RGA number. This number assures proper tracking of your instrument. Instruments that are returned without an RGA number will be sent back to the customer without being repaired. ✦**

▲ **Important** Decontaminate the instrument and remove health hazards, such as radiation, infectious diseases, corrosive agents, etc. Provide a complete description of any hazardous materials that have been used with the instrument. ▲

▲ **Important** Hamilton Company reserves the right to refuse a return shipment of any Hamilton product that has been used with radioactive or microbiological substances or any other material that could be hazardous to Hamilton employees. ▲

▲ **Important** Do not return syringes, tubing, or valves with your instrument. Hamilton Company will assume that they pose a health hazard, and will destroy them. ▲

Appendixes

Appendix A Technical Specifications for the MICROLAB 500

Appendix A contains the technical specifications for MICROLAB 500.

Table A-1 Technical Specifications for the MICROLAB 500

Reagent/Diluent Syringe	25 µL to 25 mL (TLL- or TLLX-type)
Reagent/Diluent Volume Range	1 µL-25,000 µL
Sample Syringe	25 µL to 1 mL (DX-type)
Sample Volume Range	1 µL-1,000 µL
Accuracy and Precision*	≥ 99% within 1% at 10% of syringe stroke
Resolution	.1% of syringe drive
Volume Increments	.1% of total syringe volume; adjustable
Speed**	1 to 250 seconds per full syringe stroke; adjustable
Drive	High-precision lead screws driven by a highly efficient stepper motor
Power Requirements	115/220 V; 50/60 Hz (power supply automatically converts)
Power Rating	150 VA
Weight	10 lbs., 6 oz (4.7 kg)
Dimensions	Height: 13 1/8 in (33.34 cm) Width: 6 1/8 in (15.56 cm) Depth: 7 in (17.78 cm)

continued

Table A-1 Technical Specs for the MICROLAB 500 (continued)

Shipping Dimensions	Height: 14 1/4 in Width: 21 in Depth: 14 1/2 in
Shipping Weight	20 lbs.
Storage Temperature Range	-20° to 50 °C, -4° to 122 °F
Operating Temperature Range	5° to 40 °C, 41° to 104 °F
Recommended Operating Temperature Range	18° to 25 °C, 64° to 77 °F
Humidity Range	10%–90%, non-condensing
Fluid Path	PTFE-based materials and Borosilicate glass

*Best reproducibility and accuracy are achieved at syringe stroke lengths equal to or greater than 10% of syringe volume using Hamilton syringes. Liquid handling performance may vary according to viscosity, temperature, and technique.

**Use slower drive speeds and 12-gauge tubing with larger syringes, larger volumes (greater than or equal to 10 mL), and with viscous or volatile fluids.

Hamilton Company reserves the right to alter technical specifications without notice.

Table A-2 contains specifications for syringe accuracy and precision. This information is on file at Hamilton Company in Reno, Nevada.

Table A-2 Accuracy and Precision

1 mL of Deionized Water at approximately 23 °C		
Percent Stroke	Accuracy (within +/-)	Precision (within)
1-5%	3%	1.5%
5-30%	1.2%	0.5%
30-100%	1.0%	0.2%

Pin Outs for RS-232 and TTL Ports

The following pin outs are provided for cabling both the RS-232 IN and OUT ports and the TTL ports:

For the RS-232 COMM OUT (J4):

- 1
- 2 TXD
- 3 LPBKIN
- 4 GND
- 5 CHASGND
- 6

For the RS-232 COMM IN (J3)

- 1
- 2 RXD
- 3 LPBKOUT
- 4 GND
- 5 CHASGND
- 6 +5V

For the TTL INPUT/OUTPUT

- 1 IN0
- 2 IN1
- 3 IN2
- 4 IN3
- 5 OUT0
- 6 OUT1
- 7 OUT2
- 8 OUT3
- 9 GND
- 10 GND

Appendix B Instrument Performance Test Reports

All instruments are subjected to quality control performance testing before they leave Hamilton Company. Each MICROLAB 500 system is shipped with a copy of its own performance test report. The report contains the actual results of a gravimetric test conducted on the instrument by Hamilton Company's Quality Control Department.

Keep your MICROLAB 500's performance test report for use as a benchmark of its original precision and accuracy. You may wish to periodically test your MICROLAB 500 and compare its current performance with its out-of-box-performance. Remember, when you test an instrument, you must test it under the same conditions it was originally subjected to. See your MICROLAB 500's own performance test report for specific details.

- ★ **Note:** When preparing to test a MICROLAB 500 system, do not include the first shot dispensed after system initialization as part of the performance test. Discard the first dispensed shot, then start the performance test. ★

Figure B-1 shows a sample performance test report.

Figure B-1 Sample Performance Test Report

PERFORMANCE TEST REPORT

Test PASSES

GRAVIMETRIC RESULTS FOR 50 Microliters

Balance: Sartorius

Model: R-160-P

Product/Model: ML/510B

Part No. : xxxxxx

Serial NO. : xx-xxxxxxxx

DRIVE: SINGLE

Syringe Type: 1001

Syringe Maximum Volume: 1000 Microliters

Syringe Dispense Volume: 50 Microliters

Test Method: Dispenser Diluter _____

Liquid Type: H2O Liquid Temperature in Centigrade: 22

Rel. liquid density at Exper. Temp. : .997801 mg/microliters

Actual Measurements in milligrams

1.	49.93	mg	2.	50.00	mg
3.	49.95	mg	4.	49.89	mg
5.	49.91	mg	6.	49.83	mg
7.	49.91	mg	8.	49.81	mg
9.	49.88	mg	10.	49.83	mg

RESULTS

Mean Mass: 49.894 mg Standard Deviation: 5.929153E-02 mg

Experimental Vol.= 50.00396 microliters

Parameter	Calculated	Specification	Pass/Fail
Accuracy in %	0.008	1.200	PASS
Co of Var in %	0.119	0.500	PASS

Checked by: MARIA Date: 12/13/93

Signed: Maria Doe

The product specified above has been calibrated at ambient pressure. The calibration is performed pursuant to ML-STD-45662, with an unbroken chain of calibrations traceable to N.I.S.T.

HAMILTON
THE MEASURE OF EXCELLENCESM

P.O. Box 10030, RENO, NEVADA 89520 (775) 858-3000

Appendix C Ordering Parts and Accessories for the MICROLAB 500

Appendix C contains information about ordering parts and accessories for MICROLAB 500 systems.

Table C-1 Reagent/Diluent Syringe Replacement Parts

Syringe Size	Part #	Description	Barrel	Plunger Tip	Plunger Assy. w/o Stop	Plunger Stop	Plunger Tip O-ring
25 µL	80222	1702TLLX Syringe	10280	N/A	13269	N/A	N/A
50 µL	80922	1705TLLX Syringe	10222	N/A	1117-01	N/A	N/A
100 µL	81022	1710TLLX Syringe	10223	N/A	1117-02	N/A	N/A
250 µL	81122	1725TLLX Syringe	10339	N/A	1117-03	N/A	N/A
500 µL	81222	1750TLLX Syringe	10340	N/A	1120-01	N/A	N/A
1.0 mL	81323	1001TLLX Syringe	10341	N/A	1578-01	N/A	N/A
2.5 mL	81420	1002TLL Syringe	10227	N/A	1360-01	N/A	N/A
5.0 mL	81520	1005TLL Syringe	10203	13430	13230	N/A	16114
10.0 mL	81620	1010TLL Syringe	10204	13431	13231	N/A	16104
25.0 mL	82521	1025TLL Syringe	10448	N/A	13271	N/A	N/A

Table C-2 Sample Syringe Replacement Parts

Syringe Size	Part #	Desc.	Barrel	Plunger Tip	Plunger Assy. w/o Stop	Plunger Stop	Plunger Assembly	Plunger Tip O-ring
25 µL	80226	1702DX Syringe	10436	N/A	13269	N/A	N/A	N/A
50 µL	80926	1705DX Syringe	10437	N/A	1117-01	N/A	N/A	N/A
100 µL	81026	1710DX Syringe	10438	N/A	1117-02	N/A	N/A	N/A
250 µL	81126	1725DX Syringe	10439	N/A	1117-03	N/A	N/A	N/A
500 µL	81226	1750DX Syringe	10440	N/A	1120-01	N/A	N/A	N/A
1.0 mL	81326	1001DX Syringe	10441	N/A	1578-01	N/A	N/A	N/A

Table C-3 Valve Assemblies

Part Number	Description
35825	HV Valve (Model 510B/511C)
35844	Diluter Valve (Model 530B/531C)
35842	Dispenser Valve (Model 540B/541C)

Table C-4 Tubing

Part Number	Description
240000	Fill tubing: 12-gauge 650 mm with Fittings
240010	Fill tubing: 18-gauge 650 mm with Fittings
240360	Dispense tubing: 12-gauge 900 mm with Fittings
240130	Dispense tubing: 18-gauge 900 mm with Fittings

Table C-5 Pipettors/Probes

Part Number	Description
35529	Concorde Push-button Hand Pipettor/Probe, Single Channel
35767	Dual Dispense Push-button Hand Pipettor/Probe
77006	Disposable Tip Push-button Hand Pipettor/Probe, 22-gauge x 900 mm tubing, 1–35 µL
77007	Disposable Tip Push-button Hand Pipettor/Probe, 22-gauge x 900 mm tubing, 1–125 µL
35899	Luer Lock Tip Push-button Hand Pipettor/Probe
35898	Viscous Sample Push Button Hand Pipettor/Probe
35770	Tubing Reducer, 18 gauge, for Dual Dispense Push-button Hand Pipettor/Probe (1 each)
77004	Footswitch

Table C-6 Parts and Accessories

Part Number	Description
39111	Reagent Bottle Holder
35783	Accessory Holder, also known as a Mounting Bracket (needed with reagent bottle holder)
16500	Screw, SCH Hx 4–40x .875 (two required to attach bracket)
88990	Tubing Clips (5-pack)
18310	Hamilton Syringe Cleaning Solution 70 cc
18311	Hamilton Syringe Cleaning Solution 500 cc
1524-01	Fuse, Slow Blow, 1 amp
6541000	Power Cord, 115 V, Three-prong, Grounded
355010	Power Cord, 220 V, Schuko

continued

Table C-6 Parts and Accessories (continued)

Part Number	Description
69176	<i>MICROLAB 510B/511C, 530B/531C, and 540B/541C User's Manual (English)</i>
69182	<i>MICROLAB 510B/511C, 530B/531C, and 540B/541C User's Manual (French)</i>
69180	<i>MICROLAB 510B/511C, 530B/531C, and 540B/541C User's Manual (German)</i>
69186	<i>MICROLAB 510B/511C, 530B/531C, and 540B/541C User's Manual (Portuguese)</i>
69188	<i>MICROLAB 510B/511C, 530B/531C, and 540B/541C User's Manual (Spanish)</i>

For more information about ordering parts and accessories, or upgrading your MICROLAB 500 system, contact your authorized Hamilton dealer or the Hamilton Company:

In the United States:

Hamilton Company, P.O. Box 10030, Reno, Nevada 89520-0012

Telephone Numbers (in the USA and Canada):

Technical/Customer Service 1-800-648-5950 8 a.m. to 5 p.m. PST

Instrument Service 1-800-527-5269

Outside the USA and Canada:

+1-775-858-3000

Fax Number: +1-775-856-7259

In Switzerland:

Hamilton Bonaduz AG, Ch-7402, P.O. Box 26,

Bonaduz, Switzerland

Telephone Number: +41-81-660-60-60

Fax Number: +41-81-660-60-70

Appendix D Chemical Compatibility of the MICROLAB 500

The following table contains information about chemical reactivity with the MICROLAB 500 system at room temperature.

Legend

- = No data available
- 0 = No effect, excellent
- 1 = Minor effect, good
- 2 = Moderate effect, fair
- 3 = Severe effect, not recommended

Table D-1 Chemical Compatibility

Solvent	PTFE	Kel F
Acetaldehyde	0	0
Acetates	0	0
Acetic Acid	0	0
Acetic Anhydride	0	0
Acetone	0	0
Acetyl Bromide	0	-
Ammonia	0	0
Ammonium Hydroxide	0	0
Ammonium Phosphate	0	0
Ammonium Sulfate	0	0
Amyl Acetate	0	0

continued

Table D-1 Chemical Compatibility (continued)

Solvent	PTFE	Kel F
Aniline	0	0
Benzene	0	2
Benzyl Alcohol	0	0
Boric Acid	0	0
Bromine	0	0
Butyl Alcohol	0	0
Butyl Acetate	0	2
Carbon Sulfide	0	0
Carbon Tetrachloride	0	2
Chloracetic Acid	0	0
Chlorine, liquid	0	2-3
Chlorobenzene	0	1
Chloroform	0	1
Chromic Acid	0	0
Cresol	0	0
Cyclohexane	0	1
Ethers	0	1
Ethyl Acetate	0	2
Ethyl Alcohol	0	-
Ethyl Chromide	0	1
Ethyl Ether	0	2-3
Formaldehyde	0	0
Formic Acid	0	0

continued

Table D-1 Chemical Compatibility (continued)

Solvent	PTFE	Kel F
Freon, 11, 12, 22	0	2-3
Gasoline	0	0
Glycerin	0	0
Hydrochloric Acid	0	0
Hydrochloric Acid (conc)	0	0
Hydrofluoric Acid	0	0
Hydrogen Peroxide	0	0
Hydrogen Peroxide (conc)	0	0
Hydrogen Sulfide	0	1
Kerosene	0	0
Methyl Ethyl Ketone (MEK)	0	1
Methyl Alcohol	0	0
Methylene Chloride	0	1
Naphtha	0	0
Nitric Acid	0	0
Nitric Acid (conc)	0	1
Nitrobenzene	0	1
Phenol	0	0
Pyridine	0	0
Silver Nitrate	0	1
Soap Solutions	0	0
Stearic Acid	0	-

continued

Table D-1 Chemical Compatibility (continued)

Solvent	PTFE	Kel F
Sulfuric Acid	0	0
Sulfuric Acid (conc)	0	0
Sulfurous Acid	0	1
Tannic Acid	0	1
Tanning Extracts	-	-
Tartaric Acid	0	1
Toluene	0	1
Trichlorethane	0	1
Triclorethylene	0	3
Turpentine	0	0
Water	0	0
Xylene	0	2

Appendix E Communication Protocols

Hamilton Company provides two different protocols for communication with this instrument; Protocol 1/RNO+ (Reno, USA), and DIN Protocol/BDZ+ (Bonaduz, Switzerland). These protocols use the industry standard RS-232C interface (using RXD, TXD, and GND), and allow up to 16 instruments to be linked in a daisy chain configuration. Instruments may be individually accessed via their own address, while a broadcast addressing scheme allows all instruments to be accessed simultaneously.

Note that all information transferred between the controlling device and the instrument is case sensitive, and must be sent exactly as shown.

Hamilton Protocol 1/RNO+ Syntax Overview

The Hamilton Protocol 1/RNO+ syntax is used to communicate with instruments (diluters, syringe modules, and valve positioners) designed and manufactured by Hamilton Company.

- Instruments are auto-addressed.
- Instrument addresses from "a" to "p", broadcast address ":".

Data Format

Baud Rate:	Variable
Parity:	Odd
Data bits:	7
Stop bits:	1

The Protocol 1/RNO+ syntax uses three basic control characters (Table E-1).

Table E-1 Protocol 1/RNO+ Control Characters

Notation	Name	ASCII code (decimal)	Description
<CR>	Carriage Return	13	A control character that terminates a data string.
<ACK>	Acknowledge	06	A control character transmitted by the instrument indicating an affirmative response to the controlling device.
<NAK>	Negative Acknowledge	21	A control character transmitted by the instrument indicating a non-affirmative response to the controlling device.

Auto-Addressing

*** NOTE: Instruments configured to use the Protocol 1/RNO+ syntax are assigned their addresses by auto-addressing. Hardware addressing is not supported with this protocol.**

The auto-address command should be the first sequence of characters transmitted to the instrument(s). Until the auto-address command is sent and addresses are assigned to the instrument(s), the instrument(s) will only respond to broadcast command strings.

Protocol 1/RNO+ instruments are auto-addressed using the following sequence:

1a<CR>

The first instrument in the daisy chain will be assigned the address "a", and will transmit the sequence 1b<CR> to the next instrument. The process of assigning the address received and transmitting the next address continues for all instruments in the daisy chain. The last instrument in the daisy chain responds to the controlling device with

1<last address + 1><CR>

EXAMPLE: Four instruments are on a daisy chain, and the controlling device transmits 1a<CR>. The controlling device will receive 1e<CR>, indicating that the instruments have been assigned addresses a, b, c, and d.

Data Transfer Format

Information exchange between the controlling device and the instrument is performed using the following format:

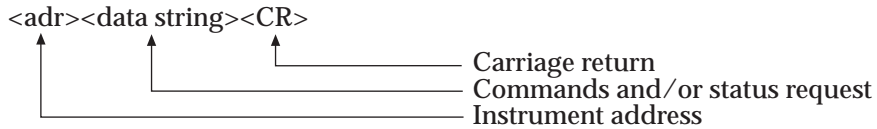

Each character transmitted to the instrument is hardware echoed as it is sent. Thus, the controlling device will receive:

<adr><data string><CR>

The instrument will respond with one of the following:



or

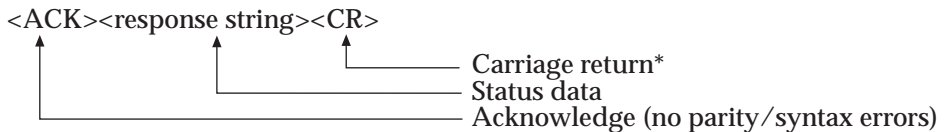

or

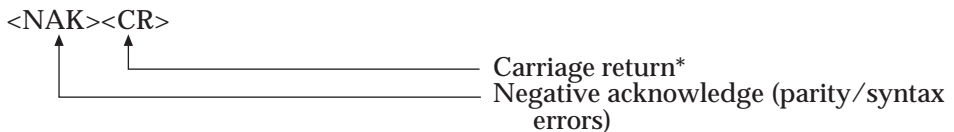

* A minimum 1 millisecond delay must occur between the controlling device receiving the <CR> of the response and the transmission of any data on a daisy chain.

Data String Components

A data string may contain one status request and/or one or more commands. Multiple status requests in a single data string should be avoided, as they are not explicitly supported. The instrument buffers the commands received until the execute command is received, at which time the commands are executed in the order received.

If a new command to a given device on the instrument is sent to the instrument before the execute command is sent, and if the instrument is unable to buffer any more commands for that device, the last command to that device will be replaced with the new command.

The instrument will ignore any new commands received for a given side of the instrument (with the exception of execution commands) while it is executing commands for that side.

A response string from the instrument contains the response to the status or parameter request sent from the controlling device.

Command Example #1: Auto-addressing the instrument

NOTE: The following example assumes a single instrument is on a daisy chain.

Controlling device transmits:

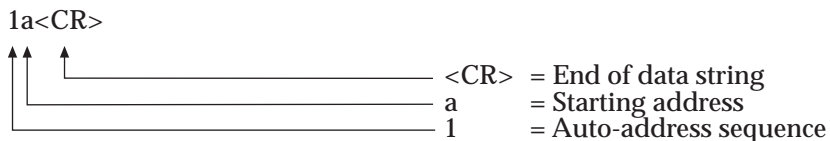

Controlling device receives:

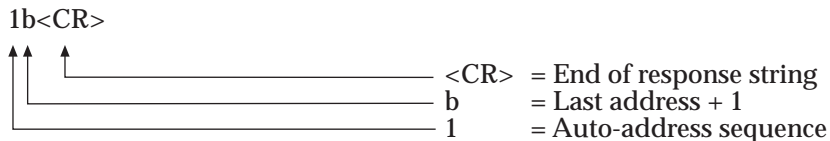

Command Example #2: Initializing the Instrument

NOTE: The following example assumes the instrument has already been auto-addressed as per the previous example.

Controlling device transmits:

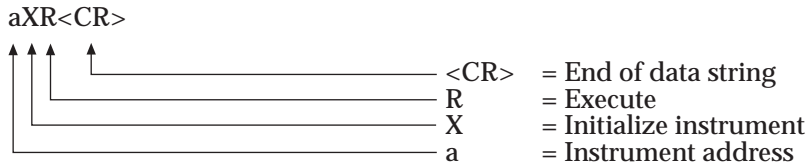

Controlling device receives:

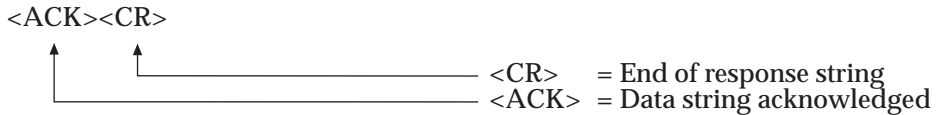

Command Example #3: A complex command

NOTE: The following example assumes the instrument has already been auto-addressed and initialized as per the previous examples.

Controlling device transmits:

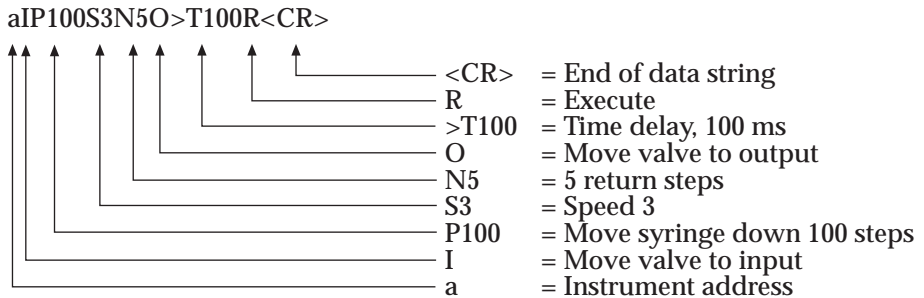

Controlling device receives:

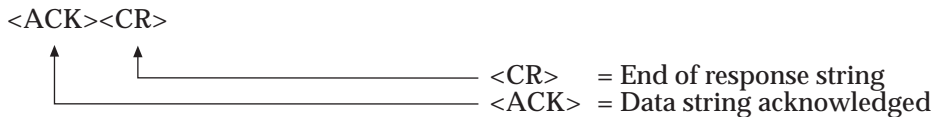

Command Example #4: A status or parameter request

NOTE: The following example assumes the instrument has already been auto-addressed as per the previous example. The response shown will vary depending upon the instrument model used.

Controlling device transmits:

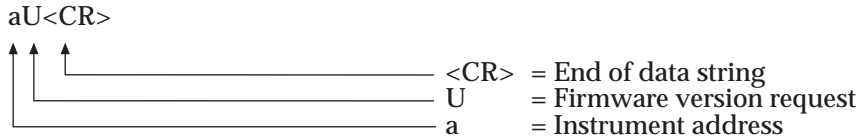

Controlling device receives:

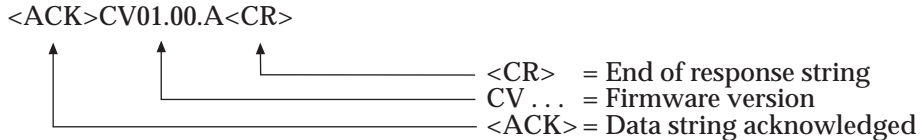

DIN Protocol/BDZ+ Syntax Overview

The DIN Protocol/BDZ+ syntax is based on the DIN 66019 standard.

- Instruments are hardware or auto-addressed.
- Instrument addresses from "01" to "16", broadcast address "00".

Data Format

Baud Rate:	Variable
Parity:	Even
Data bits:	7
Stop bits:	2

The DIN Protocol/BDZ+ syntax uses six basic control characters (Table E-2).

Table E-2 DIN Protocol/BDZ+ Control Characters

Notation	Name	ASCII code (decimal)	Description
<STX>	Start of Text	02	A control character that indicates the beginning of a Data Block.
<ETX>	End of Text	03	A control character that indicates the end of a Data Block.
<EOT>	End of Transmission	04	A control character used to terminate a Data Transfer Session.
<ENQ>	Enquiry	05	A control character used to establish a Data Transfer Session.
<ACK>	Acknowledge	06	A control character transmitted by a receiving device indicating an affirmative response to the transmitting device.
<NAK>	Negative Acknowledge	21	A control character transmitted by a receiving device indicating a non-affirmative response to the transmitting device.

Hardware Addressing

A unique address (01 through 16) must be set for each instrument on a daisy chain. Hamilton Company recommends the use of hardware addressing when using DIN Protocol/BDZ+.

Auto-Addressing

When auto-addressing is used with the DIN Protocol/BDZ+, a unique address is not required for each instrument on a daisy chain. If the addresses are not unique, however, then the auto-address sequence must be the first sequence of characters transmitted to the instruments. Failure to do so may cause communication errors.

DIN Protocol/BDZ+ instruments are auto-addressed using the following sequence:

00<ENQ>	= Broadcast address all instruments
<STX>Y<ETX>%	= Prepare RS-232 for auto-addressing
<EOT>	= Terminate Data Transfer Session
!01<EOT>	= Auto-address starting from address 01

The first instrument in the daisy chain will be assigned the address "01", and will transmit the sequence !02<EOT> to the next instrument. The process of saving the address received and transmitting the next address continues for all instruments in the daisy chain. The controlling device will NOT receive any indication as to the number of devices that have been auto-addressed.

Establishing a Data Transfer Session

Before a Data Transfer Session may take place between the controlling device and an instrument, the controlling device must first address the instrument. An instrument is addressed using the following sequence:

<ADR><ENQ>

Establish data transfer session
Instrument address

where <ADR> is "01" - "16". If the instrument is properly connected to the daisy chain, it will respond with:

<ADR><ACK>

Acknowledge
Instrument address

At this time, a Data Transfer Session may take place between the controlling device and the instrument.

Terminating a Data Transfer Session

The controlling device terminates a Data Transfer Session with the instrument(s) by transmitting an <EOT>. The instrument(s) will not acknowledge the reception of the <EOT>.

Data Transfer Session

A Data Transfer Session is initiated by the controlling device by transmitting a Data Block to the instrument. If a status request is sent to the instrument, the instrument will respond with a Data Block to the controlling device with the requested information. The controlling device may transmit as many or as few Data Blocks to the instrument as necessary, however, all Data Blocks from both the controlling device and the instrument must be completed before terminating the Data Transfer Session.

Data Block Format

Data is transmitted between the controlling device and the instrument in Data Blocks. Data Blocks may only be exchanged during Data Transfer Sessions. The format of a Data Block is as follows:

<STX><data string><ETX><BCC>

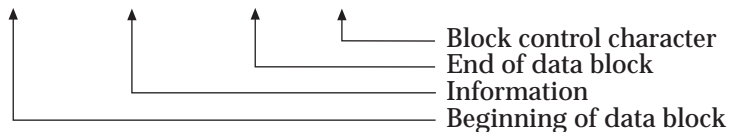

The receiver of a Data Block will reply with <ACK> if the Data Block was received with no communication errors and has a valid BCC. It will reply with a <NAK> otherwise.

The BCC (Block Control Character) is a 7-bit value used to detect errors in a Data Block. The BCC is the inverse of the result of Exclusive OR'ing (XOR) of all of the bytes in the data string and the <ETX>:

BCC = 0

BCC = BCC XOR <data string byte #1>

BCC = BCC XOR <data string byte #2>

...

BCC = BCC XOR <data string byte #n>

BCC = BCC XOR <ETX>

BCC = bit-wise inverse BCC

BCC = BCC truncated to 7-bits

For example, the BCC for the auto-address data block <STX>Y<ETX> is computed as:

BCC = 0

BCC = BCC XOR "Y" (59 Hex), result is 59 Hex

BCC = BCC XOR <ETX> (03 Hex), result is 5A Hex

BCC = Inverse BCC, result is A5 Hex

BCC = BCC truncated to 7-bits, result is 25 Hex, "%" ASCII

Data String Components

A data string from the controlling device may contain one status request and/or one or more commands. Multiple status requests in a single data string should be avoided, as they are not explicitly supported. The instrument buffers the commands received until the execute command is received, at which time the commands are executed in the order received.

If a new command to a given device on the instrument is sent to the instrument before the execute command is sent, and if the instrument has no more room to buffer that command, the last command to that device will be replaced with the new command.

The instrument will ignore any new commands received to devices on a given side of the instrument (with the exception of execution commands) while it is executing commands for that side from its buffer.

A data string from the instrument contains the response to the status or parameter request sent from the controlling device.

Command Example #1: Auto-addressing the instrument

NOTE: The following example assumes a single instrument is on a daisy chain.

Controlling device transmits:

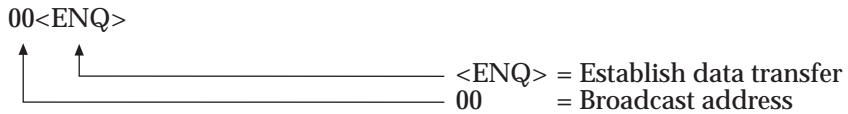

Controlling device transmits:

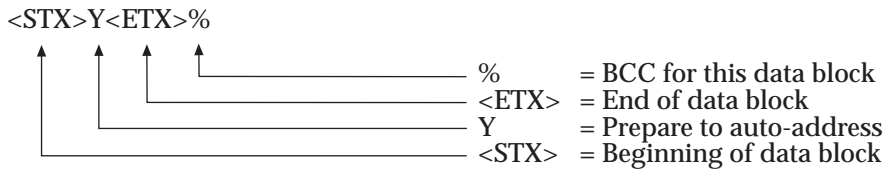

Controlling device transmits:



Controlling device transmits:

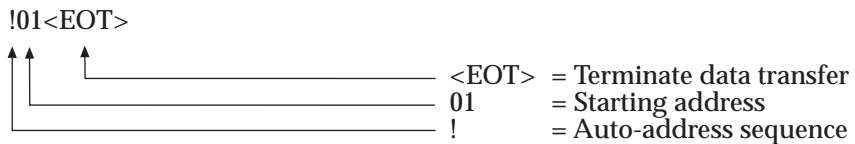

Command Example #2: Initializing the Instrument

NOTE: The following example assumes the instrument is hardware addressed at address 1, or has already been auto-addressed as per the previous example.

Controlling device transmits:

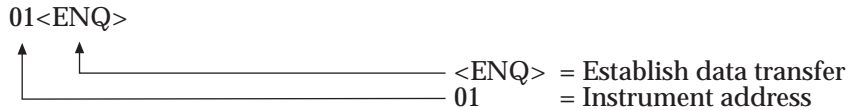

Controlling device receives:

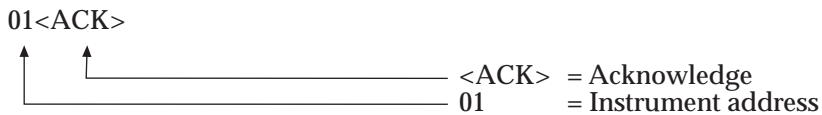

Controlling device transmits:

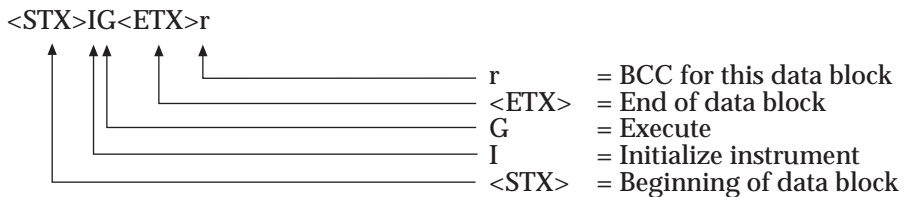

Controlling device receives:

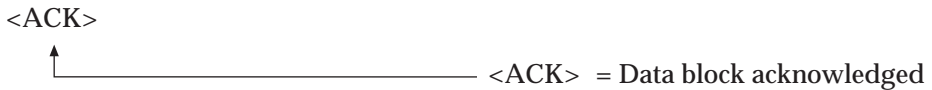

Controlling device transmits:



Command Example #3: A complex command

NOTE: The following example assumes the instrument is hardware addressed at address 1, or has already been auto-addressed as per the previous example, and has been initialized as per the previous examples.

Controlling device transmits:

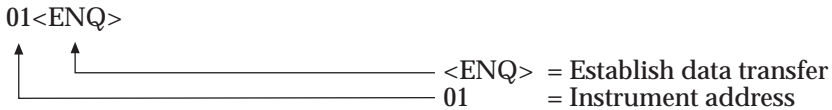

Controlling device receives:

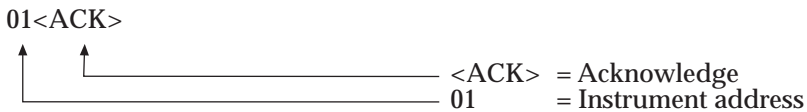

Controlling device transmits:

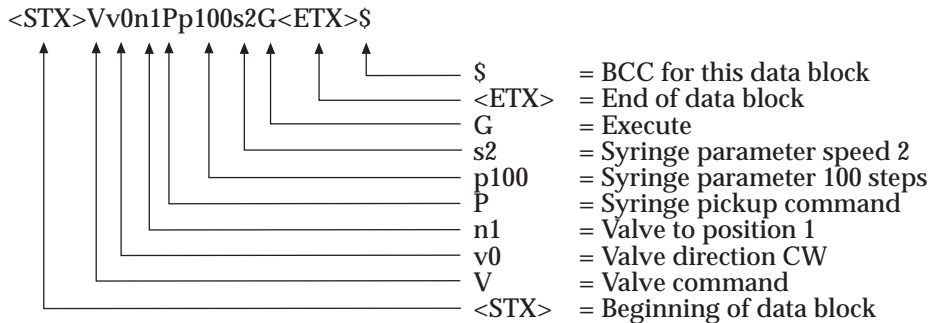

Controlling device receives:

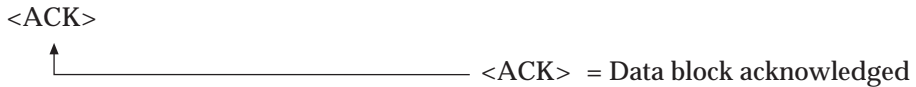

Controlling device transmits:

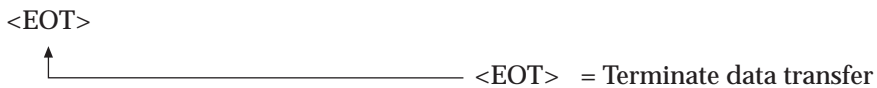

Command Example #4: A status request

NOTE: The following example assumes the instrument is hardware addressed at address 1, or has already been auto-addressed as per the previous example, as per the previous example. The response shown will vary depending upon the instrument model used.

Controlling device transmits:

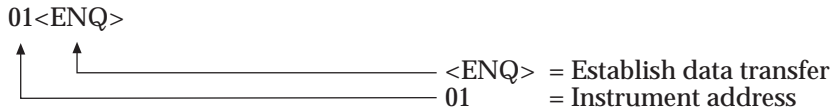

Controlling device receives:

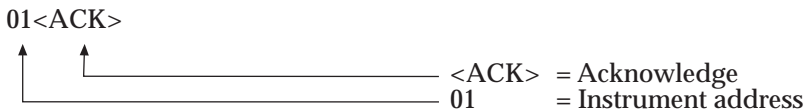

Controlling device transmits:

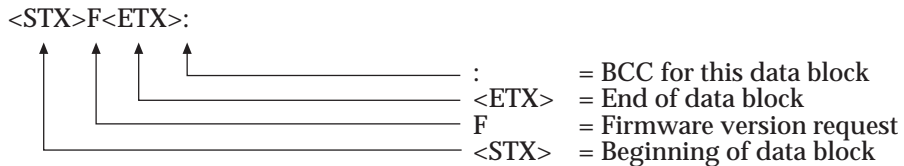

Controlling device receives:

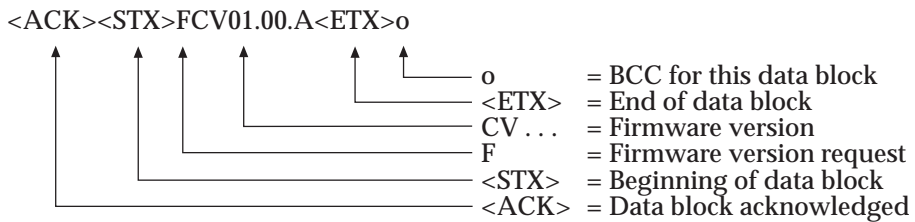

Controlling device transmits:

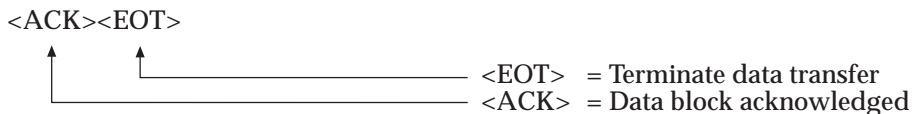

Broadcast Addressing

In addition to addressing a single unit on a daisy chain, both Protocol 1/RNO+ and DIN Protocol/BDZ+ allow all units on a daisy chain to be addressed at once using the broadcast address. Note, however, that the instrument(s) will NOT transmit protocol or status information when addressed with the broadcast address (to ensure no corruption of data on the serial line when multiple instruments attempt to transmit data at the same time).

Stored Methods

This instrument is capable of storing only one method in non-volatile memory. Storing a method on an instrument allows the instrument to perform a specific sequence of operations without the intervention of a controlling device. The stored method must be entered into the instrument using RS-232 and the configured protocol.

Stored Method Definition

A stored method consists of a method environment (the instrument's environmental parameters for the method) and one or more sequentially executed functions. Each function is a copy of an instrument command buffer, thus it may contain any or all of the commands the instrument can buffer at one time. A function will be automatically executed if the execute command was included with the command string, otherwise the function will be executed after an external trigger.

Creating Stored Methods

Using the appropriate protocol commands for the instrument, perform the following steps:

1. Issue the Stored Method Parameter Change command with the parameter to erase all methods if this has not been done before.
2. Load the required environmental parameters into the instrument.

3. Issue the Stored Method Parameter Change command with the parameter to begin method download for the desired method number.
4. Enter the command strings in order of execution. All commands for a given function **MUST** be sent in the same data string, as each function is stored after the receipt of each data string.
5. Issue the Stored Method Parameter Change command with the parameter to end method download.
6. If the instrument can store more than one method, select the desired method.
7. Power the instrument OFF then ON to active the method.

Stored Method Execution

The instrument's environmental parameters are overwritten by those for a given method when the method is selected. These parameters will stay in effect until a new method is selected.

Upon receipt of the first trigger command, the instrument will begin execution of the first function in the method. If the instrument was not previously initialized, the instrument will automatically initialize all devices before executing the first function. The instrument will continue to execute the functions in the method until the last function has completed. The instrument will then automatically restart the method beginning with the first function.

The status of the instrument may be monitored via the RS-232 line while a stored method is running. All status and execution control commands are recognized while a stored method is running.

Appendix F Protocol Command Summary

This section provides detailed information on the two protocols supported by Hamilton Company: Protocol 1/RNO+ and DIN Protocol/BDZ+.

- Channel Selection commands
- Initialization Commands
- Syringe Positioning Commands
- Valve Positioning Commands
- Timer and Digital I/O Commands
- Execution commands
- Instrument Control Commands
- Syringe Parameter Change
- Valve Parameter Change
- Stored Method Parameter Change
- Instrument Information Requests
- Instrument Status Requests
- Syringe Parameter Request
- Valve Parameter Request
- Timer and Digital I/O Requests
- Firmware Version Request

Channel Selection Commands

Table F-1 Channel Selection Commands

Protocol 1/RNO+		DIN Protocol/BDZ+		Description
Command	Parameters	Command	Parameters	
B		S	c0	Select left channel
C		S	c1	Select right channel

For instruments without dual valve or syringe capabilities, all devices are considered to be on the left (default) side. Commands attempted on the right side will result in an error.

If a channel selection command is not sent before a given command, the left (default) side is assumed as the target for commands and parameter change requests, and the instrument as a whole for status requests. Exceptions to this rule are noted after the given commands.

Initialization Commands

Table F-2 Initialization Commands

Protocol 1/RNO+		DIN Protocol/BDZ+		Description
Command	Parameters	Command	Parameters	
X	Sxxx	I	jxxx	Initialize Instrument xxx = Initialization speed in seconds per full stroke Initialization sequence: 1) Valve(s) to output position 2) Syringe(s) drive up until overload (bottomed out) 3) Valve(s) to input position 4) Syringe(s) back off backoff steps
X1	Sxxx	I2	jxxx	Initialize Syringe(s) Only xxx = Initialization speed in seconds per full stroke
X2	Sxxx	I3	jxxx	Initialize Syringe(s) Only xxx = Initialization speed in seconds per full stroke If a syringe overloads before the top of the stroke, set the 'syringe move' error bit.
LX		I1		Initialize Valve(s) Only Initialization sequence: 1) Rotate valve(s) at least 395° 2) Stop valve(s) at the input position

If a channel has not been explicitly specified via one of the channel selection commands, the initialization commands will be performed on all sides available on the instrument.

If a speed is specified with DIN Protocol/BDZ+, that speed will become the default for the syringe(s) specified.

The instrument will not execute any initialization commands until an execute command or an external trigger is received.

Syringe Positioning Commands

Table F-3 Syringe Positioning Commands

Protocol 1/RNO+		DIN Protocol/BDZ+		Description
Command	Parameters	Command	Parameters	
Pxxxx	Snnn Nr	P	pxxxx ennn cr	Syringe Pickup xxxx = steps (0-1050 half resolution, 0-2100 full resolution) nnn = Syringe drive speed in seconds per full stroke r = return steps (0-9)
Dxxxx	Snnn	D	dxxxx fnnn	Syringe Dispense xxxx = steps (0-1050 half resolution, 0-2100 full resolution) nnn = Syringe drive speed in seconds per full stroke
Mxxxx	Snnn Nr	M	mxxxx xnnn cr	Syringe Absolute Move xxxx = steps (0-1050 half resolution, 0-2100 full resolution) nnn = Syringe drive speed in seconds per full stroke r = return steps (0-9)

If a speed is specified with DIN Protocol/BDZ+, that speed will become the default for the syringe(s) specified.

If return steps are specified with DIN Protocol/BDZ+, that number of return steps will become the default for the syringe(s) specified.

The instrument will not execute any syringe positioning commands until an execute command or an external trigger is received.

Valve Positioning Commands

Table F-4 Valve Positioning Commands

Protocol 1/RNO+		DIN Protocol/BDZ+		Description
Command	Parameters	Command	Parameters	
I				Valve to Input Position (position 1)
O				Valve to Output Position (position 4)
W				Valve to Wash Position (position 3)
LPdpp LAdaaa		V	vd npp waaa	Valve Positioning d = direction (0 = CW, 1 = CCW) pp = valve position (1-8) aaa = valve angle in absolute angles from 0° in 15° increments

The instrument will not execute any valve positioning commands until an execute command or an external trigger is received.

Timer and Digital I/O Commands

Table F-5 **Timer and Digital I/O Commands**

Protocol 1/RNO+		DIN Protocol/BDZ+		Description
Command	Parameters	Command	Parameters	
>Dxxx		S	dxxx	TTL Data Output xxx = TTL data (decimal)
>Txxxx		S	txxx	Timer Delay xxxx = delay time in milliseconds (0-9999)

There is a maximum of one Digital I/O device on a system, however, it may be accessed with all valid channel selections.

The instrument will not execute any timer or digital I/O commands until an execute command or an external trigger is received.

Execution Commands

Table F-6 Execution Commands

Protocol 1/RNO+		DIN Protocol/BDZ+		Description
Command	Parameters	Command	Parameters	
R	1wxyz	G	gwxzy	Execute Command Selective Execute Command wxyz = 4 bytes of ASCII data: Bit: 7 6 5 4 3 2 1 0 w = 0 1 0 0 16 15 14 13 x = 0 1 0 0 12 11 10 9 y = 0 1 0 0 8 7 6 5 z = 0 1 0 0 4 3 2 1 Numbers 1-16 refer to the instrument number on the daisy chain 1 = Execute command 0 = No operation
K		U	k	Halt execution of commands
\$		U	r	Resume execution of commands
V		U	c	Clear all buffered commands

If a channel has not been explicitly specified via one of the channel selection commands, the execution commands will be performed on all sides available on the instrument.

The execute command informs the instrument to execute all buffered commands (initialization, syringe positioning, valve positioning, or timer and digital I/O commands).

Instrument Control Commands

Table F-7 Instrument Control Commands

Protocol 1/RNO+		DIN Protocol/BDZ+		Description
Command	Parameters	Command	Parameters	
!		R		Total System Reset
		Y		Prepare RS-232 for auto-addressing if this command sent via a broadcast address
ET		U	t	Perform instrument diagnostic

These commands are not effected by channel selection commands.

Syringe Parameter Change

Table F-8 Syringe Parameter Change

Protocol 1/RNO+		DIN Protocol/BDZ+		Description
Command	Parameters	Command	Parameters	
YSSxxx				Set syringe default speed xxx = Syringe drive speed in seconds per full stroke
YSNx				Set default return steps x = return steps (0-9)
YSMx		S	mx	Set syringe mode x = mode, default = 0 0 = Half resolution, 1000 steps per stroke 1 = Full resolution, 2000 steps per stroke 2 = Full resolution with overload detection disabled
YSBxx		S	bxx	Set default backoff steps xx = steps (0-99)

Syringe return steps are used to compensate for the mechanical drive system backlash, which improves accuracy and precision. Return steps are added to all downward movements, which are then subtracted by an upward movement immediately following the downward movement.

Syringe backoff steps are used to improve accuracy and precision by adjusting the zero position of the drive a small distance away from the initialization overload point.

Valve Parameter Change

Table F-9 Valve Parameter Change

Protocol 1/RNO+		DIN Protocol/BDZ+		Description
Command	Parameters	Command	Parameters	
LSTx		S	vx	Set Valve Configuration x = Valve type (1-7) 1 = 4 ports at -90° 2 = 8 ports at 45° 3 = 6 ports at 60° 4 = 3 ports at 90° 5 = 2 ports at 180° 6 = 2 ports at 90° 7 = 4 ports at 90°
LSFx		S	zx	Set Valve Speed x = Valve speed (0-9) 0 = 30 Hz 1 = 40 Hz 2 = 50 Hz 3 = 60 Hz 4 = 70 Hz 5 = 80 Hz 6 = 90 Hz 7 = 100 Hz 8 = 110 Hz 9 = 120 Hz

Stored Method Parameter Change

Table F-10 Stored Method Parameter Change

Protocol 1/RNO+		DIN Protocol/BDZ+		Description
Command	Parameters	Command	Parameters	
#SPx		S	ex	Set Stored Method mode x = Mode (0-9)

This command is not effected by channel selection commands.

Instrument Information Requests

Table F-11 Instrument Information Requests

Protocol 1/RNO+		DIN Protocol/BDZ+		Description
Request	Answer	Request	Answer	
F	x			Instrument done request x = Instrument status Y= Instrument is idle and command buffer is empty N = Instrument is idle and command buffer is not empty * = Instrument is busy
Z	x			Syringe error request x = Syringe status Y= Syringe overload or initialization error N = No syringe error * = Instrument is busy

continued

Table F-11 Instrument Information Requests (continued)

Protocol 1/RNO+		DIN Protocol/BDZ+		Description
Request	Answer	Request	Answer	
G	x			Valve error request x = Valve status Y= Valve overload or initialization error N = No valve error * = Instrument is busy
H	x			Instrument configuration x = Instrument configuration Y= 1 valve, 1 syringe N = Not 1 valve, 1 syringe * = Instrument is busy
J	x			Instrument configuration x = Instrument configuration Y= 1 valve, 2 syringe N = Not 1 valve, 2 syringe * = Instrument is busy
Q	x			Hand/Foot switch status x = Switch status Y= Switch pressed N = Switch not pressed * = Instrument is busy

Instrument Status Requests

F-12 Instrument Status Requests

Protocol 1/RNO+		DIN Protocol/BDZ+		Description
Request	Answer	Request	Answer	
E1	x	Q	Qx	<p>Instrument Status Request x = Instrument status byte</p> <p>Bit definition for byte x:</p> <ul style="list-style-type: none"> 0: Instrument idle, command buffer is not empty 1: Syringe drive(s) busy 2: Valve drive(s) busy 3: Syntax Error 4: Instrument Error (valve or syringe error) 5: Always 0 6: Always 1 7: Always 0 <p>Bit = 1, condition is TRUE Bit = 0, condition is FALSE</p> <p>Instrument Error bit is reset after an Instrument Error Request</p> <p>Syntax Error bit is reset after the response is sent</p>
E2	abcd	Xi	Xiabcd	<p>Instrument Error Request abcd = Instrument error bytes</p> <p>Bit definition for byte a, left syringe error(s):</p> <ul style="list-style-type: none"> 0: Not initialized 1: Overload error 2: Stroke too large

				<p>3: Initialization error 4: Non-existent 5: Always 0 6: Always 1 7: Always 0</p> <p>Bit definition for byte b, left valve error(s): 0: Not initialized 1: Initialization error 2: Overload error 3: Always 0 4: Non-existent 5: Always 0 6: Always 1 7: Always 0</p> <p>Bit definition for byte c right syringe error(s): 0: Not initialized 1: Overload error 2: Stroke too large 3: Initialization error 4: Non-existent 5: Always 0 6: Always 1 7: Always 0</p> <p>Bit definition for byte d right valve error(s): 0: Not initialized 1: Initialization error 2: Overload error 3: Always 0 4: Non-existent 5: Always 0 6: Always 1</p>
--	--	--	--	--

				<p>7: Always 0</p> <p>Bit = 1, condition is TRUE Bit = 0, condition is FALSE</p> <p>For instruments with a single valve and/or syringe, the valve and/or syringe is considered to be on the left side. The right side valve and/or syringe is considered to not exist.</p>
		E	Eab	<p>Instrument Error Request ab = Instrument error bytes</p> <p>Bit definition for byte a, syringe(s) error(s):</p> <ul style="list-style-type: none"> 0: Not initialized 1: Overload error 2: Stroke too large 3: Initialization error 4: Non-existent 5: Always 0 6: Always 1 7: Always 0 <p>Bit definition for byte b, valve(s) error(s):</p> <ul style="list-style-type: none"> 0: Not initialized 1: Initialization error 2: Overload error 3: Always 0 4: Non-existent 5: Always 0 6: Always 1 7: Always 0 <p>Bit = 1, condition is TRUE Bit = 0, condition is FALSE</p>

		C	Cx	<p>Instrument Configuration x = Configuration byte</p> <p>Bit definition for byte x:</p> <ul style="list-style-type: none"> 0: Always 0 1: Valve drive available 2: Syringe drive available 3: Self test active 4: Always 0 5: Always 0 6: Always 1 7: Always 0 <p>Bit = 1, condition is TRUE Bit = 0, condition is FALSE</p>
E3	x	Xs	Xsx	<p>Instrument Device Status x = Device status byte</p> <p>Bit definition for byte x:</p> <ul style="list-style-type: none"> 0: Timer(s) busy 1: Self test busy 2: Stored method busy 3: IIC Error 4: Over temperature error 5: Always 0 6: Always 1 7: Always 0 <p>Bit = 1, condition is TRUE Bit = 0, condition is FALSE</p>
E4	ab	Xe	Xeab	<p>Instrument Sensor Status x = Sensor status bytes</p> <p>Bit definition for byte a:</p> <ul style="list-style-type: none"> 0: Left syringe encoder A 1: Left syringe encoder B 2: Left valve encoder 3: Always 0

				<p>4: Always 0 5: Always 0 6: Always 1 7: Always 0</p> <p>Bit definition for byte b:</p> <p>0: Right syringe encoder A 1: Right syringe encoder B 2: Right valve encoder 3: Always 0 4: Always 0 5: Always 0 6: Always 1 7: Always 0</p> <p>For instruments with a single valve and/or syringe, the valve and/or syringe is considered to be on the left side. The right side valve and/or syringe sensor values are undefined.</p>
T1	x	Xb	Xbx	<p>Instrument Busy Status x = Busy status byte</p> <p>Bit definition for byte x:</p> <p>0: Left valve busy 1: Left syringe busy 2: Right valve busy 3: Right syringe busy 4: Prime/Step active 5: Hand/Foot switch active 6: Always 1 7: Always 0</p> <p>Protocol 1/RNO+: Bit = 0, condition is TRUE Bit = 1, condition is FALSE</p>

				<p>DIN Protocol/BDZ+:</p> <p>Bit = 1, condition is TRUE Bit = 0, condition is FALSE</p> <p>For instruments with a single valve and/or syringe, the valve and/or syringe is considered to be on the left side. The right side valve and/or syringe busy status is always FALSE.</p>
T2	x			<p>Instrument Error Status x = Error status byte</p> <p>Bit definition for byte x:</p> <p>0: Left valve error 1: Left syringe error 2: Right valve error 3: Right syringe error 4: Always 0 5: Always 0 6: Always 1 7: Always 0</p> <p>Bit = 0, condition is TRUE Bit = 1, condition is FALSE</p> <p>For instruments with a single valve and/or syringe, the valve and/or syringe is considered to be on the left side. The right side valve and/or syringe error status is always FALSE.</p>

These commands are not effected by channel selection commands.

Syringe Parameter Request

Table F-13 Syringe Parameter Request

Protocol 1/RNO+		DIN Protocol/BDZ+		Description
Request	Answer	Request	Answer	
YQS	xxx			Syringe default speed xxx = Syringe drive speed in seconds per full stroke
YQN	x			Syringe default return steps x = return steps (0-9)
YQP	xxxx	Ay	Ayxxxx	Syringe position xxxx = steps (0-1050 half resolution, 0-2100 full resolution)
YQE	xxxx	An	Anxxxx	Syringe encoder position xxxx = steps (0-1050 half resolution, 0-2100 full resolution)
YQM	x	Am	Amx	Syringe mode x = mode (0-2) 0 = Half resolution, 1000 steps per stroke 1 = Full resolution, 2000 steps per stroke 2 = Full resolution with overload detection disabled
YQB	xx	Ab	Abxx	Syringe default backoff steps xx = backoff steps (0-99)

Valve Parameter Request

Table F-14 Valve Parameter Request

Protocol 1/RNO+		DIN Protocol/BDZ+		Description
Request	Answer	Request	Answer	
LQP	xx	Ap	Apxx	Valve position xx = valve position (1-8)
LQA	xxx	Aa	Aaxxx	Valve angle xxx = valve angle (0-345)
LQT	x	Av	Avx	Valve Configuration x = Valve type (1-7) 1 = 4 ports at -90° 2 = 8 ports at 45° 3 = 6 ports at 60° 4 = 3 ports at 90° 5 = 2 ports at 180° 6 = 2 ports at 90° 7 = 4 ports at 90°
LQF	x	Az	Azx	Valve Speed x = Valve speed (0-9) 0 = 30 Hz 1 = 40 Hz 2 = 50 Hz 3 = 60 Hz 4 = 70 Hz 5 = 80 Hz 6 = 90 Hz 7 = 100 Hz 8 = 110 Hz 9 = 120 Hz

Timer and Digital I/O Requests

Table F-15 Timer and Digital I/O Requests

Protocol 1/RNO+		DIN Protocol/BDZ+		Description
Request	Answer	Request	Answer	
<D	xxx	Ad	Adxxx	TTL Dat Input xxx = TTL data (decimal)
<T	xxxx	At	Atxxxx	Timer Delay Value xxxx = current delay time in milliseconds (0-9999)

There is a maximum of one Digital I/O device on a system, however, it may be accessed with all valid channel selections.

Firmware Version Request

Table F-16 Firmware Version Request

Protocol 1/RNO+		DIN Protocol/BDZ+		Description
Request	Answer	Request	Answer	
U	xxii.jj.k	F	FXXii.jj.k	<p>Firmware Version Request XX = Product Identifier ii = Major version (01-99) jj = Minor version (01-99) k = Revision (A-Z)</p> <p>Product Identifiers/Version AV07 = ML900, original AV08 = ML900, PSD/2 valve AV09 = ML900, ML900 valve BV01 = ML500A, original BV02 = ML500A, current CV01 = ML500B and ML500C DV01 = ML500C, OEM OM01 = PSD/2 MV = MVP</p>

This command is not effected by channel selection commands.

ASCII Chart

The following chart shows the relationship between binary numbers, decimal numbers, hexadecimal numbers, and their ASCII equivalents for the numbers between 0 and 127.

Table F-17 ASCII Chart

Binary	Decimal	Hex	ASCII	Binary	Decimal	Hex	ASCII
00000000	0	00	<NUL>	00010111	23	17	<ETB>
00000001	1	01	<SOH>	00011000	24	18	<CAN>
00000010	2	02	<STX>	00011001	25	19	
00000011	3	03	<ETX>	00011010	26	1A	<SUB>
00000100	4	04	<EOT>	00011011	27	1B	<ESC>
00000101	5	05	<ENQ>	00011100	28	1C	<FS>
00000110	6	06	<ACK>	00011101	29	1D	<GS>
00000111	7	07	<BEL>	00011110	30	1E	<RS>
00001000	8	08	<BS>	00011111	31	1F	<US>
00001001	9	09	<HT>	00100000	32	20	
00001010	10	0A	<LF>	00100001	33	21	!
00001011	11	0B	<VT>	00100010	34	22	"
00001100	12	0C	<FF>	00100011	35	23	#
00001101	13	0D	<CR>	00100100	36	24	\$
00001110	14	0E	<SO>	00100101	37	25	%
00001111	15	0F	<SI>	00100110	38	26	&
00010000	16	10	<DLE>	00100111	39	27	'
00010001	17	11	<DC1>	00101000	40	28	(
00010010	18	12	<DC2>	00101001	41	29)
00010011	19	13	<DC3>	00101010	42	2A	*
00010100	20	14	<DC4>	00101011	43	2B	+
00010101	21	15	<NAK>	00101100	44	2C	,
00010110	22	16	<SYN>	00101101	45	2D	-

Binary	Decimal	Hex	ASCII	Binary	Decimal	Hex	ASCII
00101110	46	2E	.	01000110	70	46	F
00101111	47	2F	/	01000111	71	47	G
00110000	48	30	0	01001000	72	48	H
00110001	49	31	1	01001001	73	49	I
00110010	50	32	2	01001010	74	4A	J
00110011	51	33	3	01001011	75	4B	K
00110100	52	34	4	01001100	76	4C	L
00110101	53	35	5	01001101	77	4D	M
00110110	54	36	6	01001110	78	4E	N
00110111	55	37	7	01001111	79	4F	O
00111000	56	38	8	01010000	80	50	P
00111001	57	39	9	01010001	81	51	Q
00111010	58	3A	:	01010010	82	52	R
00111011	59	3B	;	01010011	83	53	S
00111100	60	3C	<	01010100	84	54	T
00111101	61	3D	=	01010101	85	55	U
00111110	62	3E	>	01010110	86	56	V
00111111	63	3F	?	01010111	87	57	W
01000000	64	40	@	01011000	88	58	X
01000001	65	41	A	01011001	89	59	Y
01000010	66	42	B	01011010	90	5A	Z
01000011	67	43	C	01011011	91	5B	[
01000100	68	44	D	01011100	92	5C	\
01000101	69	45	E	01011101	93	5D]

Binary	Decimal	Hex	ASCII	Binary	Decimal	Hex	ASCII
01011110	94	5E	^	01101111	111	6F	o
01011111	95	5F	_	01110000	112	70	p
01100000	96	60	`	01110001	113	71	q
01100001	97	61	a	01110010	114	72	r
01100010	98	62	b	01110011	115	73	s
01100011	99	63	c	01110100	116	74	t
01100100	100	64	d	01110101	117	75	u
01100101	101	65	e	01110110	118	76	v
01100110	102	66	f	01110111	119	77	w
01100111	103	67	g	01111000	120	78	x
01101000	104	68	h	01111001	121	79	y
01101001	105	69	i	01111010	122	7A	z
01101010	106	6A	j	01111011	123	7B	{
01101011	107	6B	k	01111100	124	7C	
01101100	108	6C	l	01111101	125	7D	}
01101101	109	6D	m	01111110	126	7E	~
01101110	110	6E	n	01111111	127	7F	

ML500B Default Environmental Parameters

The ML500B default environmental parameters are listed as follows:

Syringe mode:	0
Syringe speed:	4
Syringe return steps:	3
Syringe backoff steps:	15
Left valve type:	7
Right valve type:	1
Valve speed:	3

This instrument supports syringe speeds in the range from 1 to 250 seconds per full stroke. For speeds greater than 6, a microstepping scheme is used to provide smoother drive operation. The number of microsteps per full step for a given speed is the integral portion of the speed divided by 2.

The default values for this instrument are designed to optimize performance. Please contact Hamilton Company if a valve speed greater than 60Hz is required.

ML500B Command Buffer

The ML500B can buffer the following commands for execution on both the left and right side:

- 2 valve commands
- 1 syringe command
- 1 timer delay command
- 1 digital output command

ML500B Methods

The ML500B can store a single method of 67 functions into non-volatile memory. The ML500B will automatically select the stored method after the method has been downloaded and after powerup.

ML500B Specific Protocol Information

Perform Instrument Diagnostic (RNO+ 'ET', BDZ+ 'Ut')

The ML500B does not have a diagnostic mode. The ML500B will ignore this command.

Set Stored Method mode (RNO+ '#SP', BDZ+ 'Se')

ML500B supports the following Stored Method modes:

- 0 = End method download
- 1 = Start method download for method #1
- 2 = Erase all methods.
- 3 = Temporarily disable method execution
- 4 = Enable method execution

Digital I/O Command (RNO+ '>D', BDZ+ 'Sd')

The ML500B provides 4 bits (0 - 15 decimal) of digital output.

Digital I/O Request (RNO+ '<D', BDZ+ 'Ad')

The ML500B provides 4 bits (0 - 15 decimal) of digital input.

Instrument Device Status (RNO+ 'E3', BDZ+ 'Xs')

The ML500B does not support IIC, so the IIC Error bit is always 0.

Glossary

active valve

A valve that can switch the flow of liquid between at least two valve positions, including: 1) the valve input port to syringe and 2) the valve output port to syringe.

air gap

A segment of air that is aspirated through the probe, used to separate different liquids in the tubing lines.

aliquot dispense method

A method in which fluid is distributed in equal increments.

arrow keys

Keys that are located on the controller unit; used to move from field to field on the display screen.

aspirate

To pick up a designated volume of sample or air from the valve output port into a probe or tubing.

baud

A measurement of the speed at which information can be transmitted between instruments. If the baud rate is 9600, 9600 bits can be transmitted per second.

bit

A binary digit, or digit with a value of zero or one; the smallest unit of electronic information.

busy bit

A hardware control signal used to indicate that an instrument on a daisy chain is engaged in executing a command received from the master controller.

byte

A sequence of adjacent bits representing one character of information, usually consisting of 8 bits.

cavitation

An occurrence caused by applying a high vacuum to a liquid (gas dissolved in liquid can be pulled out of solution). It generally occurs when large syringes (5 and 10 mL) are driven at high speeds.

command

An instruction that is transmitted from the computer to an instrument.

command string

A sequence of commands that represent an instruction when transmitted from a computer to an instrument.

Concorde hand probe

The Concorde hand probe is Hamilton Company's standard single tube hand-activated probe. The tip of this probe is adjustable and allows the user to set the dispense tubing to an angle that is comfortable for use.

controller unit

The device that allows the user to send operating instructions to the drive unit.

cycle

A series of two strokes that comprise both the up and down movements of the syringe drive arm.

daisy chain

A string of instruments connected in a serial configuration.

default

A predetermined value.

diluent

A liquid that is added to a sample to lessen the sample's concentration (i.e., to dilute the sample).

diluent syringe

A syringe that delivers a diluent. On a dual syringe unit, the diluent syringe is usually the syringe on the left.

dilute

To reduce the concentration of solutes in a sample by adding another fluid. The fluid that is added is called a “diluent” and may be deionized water, for example.

diluter

An instrument used to reduce the concentration of a liquid. The MICROLAB 530B is a dual syringe diluter.

dispense

To distribute fluid from a syringe in a single portion or in several increments out through the valve output port and attached tubing. A diluent is dispensed during dilution. Reagents and buffers can be mixed and dispensed together with a sample before analysis.

dispense tubing

Tapered tubing that allows delivery of precise amounts of liquid.

dispenser

An instrument used to distribute liquid. The MICROLAB 510B is a single syringe dispenser. The MICROLAB 540B is a dual syringe dispenser.

disposable tip

A throw-away probe tip used to avoid cross-contamination between samples.

display screen

The area on the controller unit where system messages and information appears.

Down

Describes the movement of the syringe drive arm as it moves away from the Home position and toward the bottom of the stroke.

download

To transfer information from one instrument to another. For example, you can download a method from a controller unit to an attached drive unit.

dribbling

Describes the formation of drops at the tip of tubing as liquids are dispensed. Generally occurs when small volumes are dispensed at low flow rates or when there is an air leak in the tubing lines. Drop formation can adversely affect accuracy and precision.

drive speed

Speed of the drive unit; speed is specified in seconds per full stroke (6 cm). Drive arm speeds are measured in units from 1 to 250 seconds, with 1 being the fastest speed and 250 being the slowest speed.

drive unit

The basic body of the MICROLAB 500.

dual dispenser

A two-syringe instrument that can dispense two different liquids at the same time. The volumes of the liquids being dispensed do not have to be equal. The MICROLAB 540B is a dual syringe dispenser.

duty cycle

The amount of time that an instrument syringe drive is active and functioning versus the total amount of time between repetitive operations.

fill

To fill a syringe with a volume of liquid that is pulled in from a reservoir via fill tubing through the valve input port. Drive arms move the syringes down, pulling liquid through the tubing and into the syringe.

fill tubing

A tubing line that connects the liquid reservoir to the valve inlet port.

fluid path

The inside surfaces of the valve, syringes, and tubing that contact liquid.

footswitch

A foot-activated device used to operate the MICROLAB 500.

function keys

The keys on the controller unit that allow you to perform actions based on the label on the screen that is directly over the key.

hand probe

See probe

hardware echoed

Transmission of data from one instrument to another via an electrical connection.

Home position

The position of the syringe drive arms when they are at the top of their range of movement.

inactive valve

A valve with a fixed flow passage.

initialize

To establish the basic conditions for starting an operation.

LED

Light Emitting Diode used as an indicator light on the MICROLAB 500.

luer fitting

The standard “twist and lock” type of fitting..

master controller

The device that controls all other instrument(s) on a daisy chain.

memory

The information storage area of an instrument.

menu

A list of options or commands displayed on a computer terminal or on an instrument's display panel.

method

A complete series of repeatable functions that can be performed by MICROLAB instruments. These functions may consist of filling, dispensing, diluting, etc.

MICROLAB 510B

Hamilton Company's single syringe dispenser. The controller unit can store methods.

MICROLAB 530B

Hamilton Company's dual syringe diluter/dispenser. The controller unit can store methods.

MICROLAB 540B

Hamilton Company's dual syringe dispenser. The controller unit can store methods.

numeric keypad

The group of keys on the controller unit that are used to enter numeric data.

overload

A stall in syringe plunger movement that may be caused by excess mechanical friction, excess syringe speed, or a blockage in the valves, tubing or syringes.

pipette

To measure a fixed amount of liquid with a probe.

power-down

To turn off an electrical device.

Power Indicator light

A LED on the drive unit that shows whether or not the MICROLAB system is powered on.

Power On/Off switch

A switch used to turn the MICROLAB system on.

power-on

To turn on an electrical device.

prime

To make an instrument ready for operation by running fluid through the fluid path (tubing, valves, and syringes) of an instrument to remove all bubbles and air gaps. You must prime the system prior to use and between fluid changes.

prime mode

The process of priming an instrument.

probe

A hand-held device that contains dispense tubing. Each probe also has a button that can be used to control the drive unit.

reagent/diluent syringes

Syringes that pick up and dispense reagent and diluent. The GASTIGHT TLL-type and TLLX-type syringes are reagent/diluent syringes.

reservoir

A container that holds system fluid (diluent).

return

To dispense fluid out through the valve input port and attached tubing.

Returned Goods Authorization Number (RGA#)

A number, assigned by the Hamilton Company, that is used to trace an instrument in the event it is returned for repair.

RS-232

The standard for electronically linking Hamilton instruments together; RS-232 is a serial interface.

Run/Stop key

A control used to start, stop, or pause an operation on the MICROLAB 500.

sample syringe

A syringe used to pick up a liquid sample. GASTIGHT “D” configuration syringes with side ports are sample syringes. On a dual syringe unit, the sample syringe is usually placed on the instrument’s right side.

serial dispense

To distribute fluid in increments.

serial interface

A connection that transmits data “bit by bit” with start and stop bits to separate bytes.

stall

A pause in syringe plunger movement that may be caused by excessive mechanical friction, excessive syringe speed, or a blockage in the valves, tubing, or syringes.

step

Movement of the drive arms that occurs when the Step/Prime switch is held down. The Step mode is often used to position the drive arm before changing syringes.

stroke

Movement of the syringe drive arm in one direction only; half of the drive arm's cycle. *See also* cycle.

syringe drive arm(s)

The arms to which syringe plungers connect. The movement of the syringe drive arms displaces fluid, drawing it through the system.

system fluid

Refers to the fluid originating from a reservoir, pumped through the entire system.

titrate

To determine the smallest quantity of a substance needed for a certain reaction. On the ML500, all titration methods are interactive.

tubing clip

A device that attaches to the side of the reservoir and holds tubing lines in place.

valve

The device that directs the flow of liquid through the system.

valve port

Openings in the valve assembly through which liquid flows. As the valve turns, ports are opened or closed, directing the flow of liquid through the system.

Index

A

arrow keys, 3-3

B

batteries

replacing, 4-6

baud rate, 2-5

changing default, 3-44

C

checking the system for leaks, 3-8

cleaning

syringes and tubing, 4-3

communications settings, 1-13, 2-4 to 2-6

Concorde Push-button Hand Pipettor/Probe, 1-18

controller unit

description of, 1-16

copying a method 3-40 to 3-41

creating a method

aliquot dispense, 3-17 to 3-18

custom, 3-27 to 3-29

dilution, 3-20 to 3-23

new, 3-13-16

pipette, 3-23-25

serial dispense, 3-18 to 3-19, 3-22

titrate, 3-25 to 3-26

D

daisy chain, 2-4, 2-6

deleting a method 3-39

diagnostic tests 3-43

dilutions

performing manual, 3-32 to 3-33

dispenses

performing manual, 3-34

using MICROLAB 540B as a single dispenser, 2-21

Disposable Tip Push Button Hand Pipette Probe, 1-19

downloading a method 3-41 to 3-42

drive unit

description of 1-8-13

Dual Push-button Hand Pipette Probe, 1-18

E

editing a method, 3-31

editing conventions, 3-5 to 3-6

F, G

footswitch, description of, 1-20

function keys, 3-4

fuse box, 1-13

H

hand probe connector receptacle, 1-13

I, J, K

installation

- of accessory holder, 2-3
- of electrical connections, 2-6 to 2-7
- of syringes, 2-12
- of tubing, 2-17-21
- of valve assemblies, 2-8 to 2-9
- preparing syringes for, 2-12
- selecting a location, 2-3

instruments

- chemical compatibility of, 4-5, D-1 to D-4
- cleaning exterior of, 4-4
- cleaning fluid path of, 4-2
- performance test reports, B-1-2
- quality control testing, B-1
- returning for repair, 5-16
- servicing, 5-15 to 5-16
- storing, 4-5
- when to clean, 4-2

L

language

- changing default, 3-43 to 3-44

loopback switch, 2-5

Luer Lock Tip Push-button Pipette Hand Probe, 1-19, 20

M

Main menu

- screen, 3-7

messages

- audible, 5-10
- error message code guide, 5-2 to 5-9

system, 5-2

MICROLAB 500 parts lists 1-2 to 1-7

MICROLAB 500 systems

descriptions of, PR-3

MICROLAB 504A, using as a single dispenser, 2-50

MICROLAB 540B, using as a single dispenser, 2-21

N

numeric keypad keys, 3-4

O

ordering information, A-1-4

overview of the MICROLAB 500 series of instruments, PR-3

P, Q

power cord connector receptacle,
1-13

Power On/Off switch, 1-14

prime mode, 1-14

priming the system, 3-8 to 3-12

probe button functions, 1-20

protocol switch, 2-5

R

removing syringes, 2-14

renaming a method 3-37 to 3-38

returned goods authorization
number, 5-16

RS-232 IN, 2-4, 2-6

RS-232 OUT, 2-4, 2-6

Run/Stop key, 3-4

running a method, 3-29 to 3-30

S

selecting tubing, 2-16 to 2-17

single syringe instruments

 references to, PR-5

step mode, 1-15

Step/Prime switch, 1-14

syringe drive arms

 description of, 1-15

syringes

 cleaning, 4-3

 installing, 2-12 to 2-14

 preparing for installation, 2-12

 removing

 precautions, 2-15

 removing, 2-14 to 2-15

 types of, 2-10 to 2-11

system

 descriptions of, PR-3

 powering on, 3-6

T

technical specifications, A-1 to A-2

technical support

 telephone numbers for, 5-15

troubleshooting guide, 5-11 to 5-14

TTL port, 2-4

tubing

 cleaning, 4-3

 difference between fill and
 dispense, 2-16 to 2-17

U

upgrading the MICROLAB 500
system, PR-3

usage, overview of, 3-2

Utilities menu, 3-36 to 3-37

V

valve assembly

 description of, 1-15

W, X, Y, Z

writing conventions, PR-5

HAMILTON

THE MEASURE OF EXCELLENCESM

Hamilton Company manufactures precision fluid management products: syringes, valves, diluters/dispensers, and robotic pipetting instruments, as well as polymeric HPLC columns and resins.

Hamilton Company

4970 Energy Way
Reno, Nevada 89502 USA
Toll-Free 800-648-5950
Telephone +1-775-858-3000
Fax +1-775-856-7259
sales@hamiltoncompany.com

Hamilton Bonaduz AG

P.O. Box 26
CH-7402 Bonaduz
Switzerland
Telephone +41-81-660-60-60
Fax +41-81-660-60-70
hamopd@bonaduz.hamilton.ch

Hamilton Deutschland GmbH

P.O. Box 110565
D-64220 Darmstadt
Germany
Telephone (061 51) 89 17 33
Fax (061 51) 89 17 33

Hamilton (G.B.) Limited

Unit 2, Lyne Riggs Estate
Lancaster Road, Carnforth
GB-Lancashire LA5 9EA
Telephone (01524) 720 650
Fax (01524) 720 651

<http://www.hamiltoncompany.com>

